



Eye *Instruments*

Augeninstrumente
Instruments ophtalmologiques
Instrumentos oftalmológicos
Strumenti oftalmici

Professional

**Eye Surgery
Augen-Instrumentarium
Oftalmologia
Chirurgie ophtalmologique
Oftalmologia**

PROFESSIONAL HOSPITAL FURNISHERS

19-A (N) Industrial Estate,

P.O. Box: 2095, Sialkot-51310, Pakistan.

Tel. +92 52 325 6440, 325 6441, 355 9980

Fax: +92 52 325 6442, 355 2939

Email : info@phfworld.com

Professional

Life Time Guarantee.

All Professional precision instruments are guaranteed to be free of manufacturing and workmanship defects.

Any instrument proved to be defective, excluding defects due to misuse or mishandling, shall be repaired or replaced free of cost.

We recommend the use of proper and standard instrument cleaning, handling and preserving techniques to increase the life and functionality of all kinds of surgical instruments.

Professional
HOSPITAL FURNISHERS

19-A (N), Industrial Estate, P. O. Box: 2095, Sialkot 51310 - PAKISTAN
TEL : 92 432 555885, 559980, FAX : 92 432 552939, 256441

EU DECLARATION OF CONFORMITY

We **Professional Hospital Furnishers**
(supplier's name)

19-A (N), Industrial Estate, P. O. Box 2095, Sialkot 51310 - Pakistan
(Address)

declare under our sole responsibility that the product

Surgical, Dental & Diagnostic Instruments

(name, type or model, lot, batch or serial number, possible sources and numbers of items)

to which this declaration relates is in conformity with the following standard(s) or other normative document(s)

EN 46002, ISO 13485:2003, ISO 9001:2000

(title and/or number and date of issue of the standard(s) or other normative document(s))

following the provisions of Directive(s)

Medical Device Directive No.: 93/42 EEC

CE

(if applicable)

In this respect, we have appointed the following company as our authorized representative in EU.

**MERLIN MEDICAL,
THE WHITBREAD CENTRE,
RHYMNEY, GWENT NP22 5XD, UK
TEL : 44 1685 843676, FAX : 44 1685 843860**

(Complete address and contact information)

Our company and products are registered with

**Medicines and Healthcare products
Regulatory Agency (MHRA) UK.**

(Attach registration document)

Sialkot 26.6.2001 **Aqeel Abbas**

(Place and Date of issue) (name and signature or equivalent marking of authorised person)



BVQI

Certificate of Approval
Awarded to

**PROFESSIONAL HOSPITAL FURNISHERS
19-A(N), INDUSTRIAL ESTATE, SIALKOT, 51310
PAKISTAN**

*Bureau Veritas Quality international certifies that the
Quality Management System of the above organisation
has been assessed and found to be in accordance
with the requirements of the quality
standards detailed below*

QUALITY STANDARDS

ISO 9001:2000

SCOPE OF SUPPLY

**MANUFACTURING OF SURGICAL, NON- SURGICAL,
MEDICAL, DENTAL AND DIAGNOSTIC INSTRUMENTS
AND LIPOSUCTION CANULAS**

Original approval date: **25TH SEPTEMBER 2003**

*Subject to the continued satisfactory operation of the organisation's
Quality Management System this Certification is valid for a period of three years until:*

24TH SEPTEMBER 2006

Date: **25TH SEPTEMBER 2003**

Managing Office:
Bureau Veritas Quality International
8-26/ 8E, Block - 3, Gildan
Karachi - Pakistan



For Bureau Veritas Quality International
(Holding) S.A.,
24th Floor, Tower Bridge Court
224-226 Tower Bridge Road
London SE1 2TX (UNITED KINGDOM)

L. N. A. S.
GRUPPI
MAGGIORANI

Certificate No: 138417/A **SF06/B**

BVQI (Holding) S.A. using UKAS accreditation covered by the accreditation certificate number 038

EYE SPECULA	2-8
SCALPELS AND KNIVES	10,11
KNIVES	13-15
HOOKS	16
RETRACTORS	17
LOOPS	18
SPATULAS	19-21
CHALAZION CURETTES	22,24
FOREIGN BODY INSTRUMENTS	23
LENS MANIPULATORS	25,26
IRIS HOOKS	27
CAPSULE INSTRUMENTS	28
DISSECTING AND TISSUE FORCEPS	30,31
IRIS FORCEPS	32-34
FIXATION FORCEPS	35-39
TYING FORCEPS	40-44
SUTURE FORCEPS	45-49
CORNEAL FORCEPS	50-56
CAPSULE FORCEPS	57
CAPSULOREHEXIS FORCEPS	58
NUCLEUS FORCEPS	59
FRAGMENT FORCEPS	60
CHALAZION FORCEPS	61,62
MUSCLE FORCEPS	63
MICRO NEEDLE HOLDERS	65-69
DELICATE SCISSORS	71-75
MICRO SCISSORS	76-87
LACRIMAL DILATOR	89,90
DCR-INSTRUMENTS	91
CANNULA	92-96

Professional

- Eye surgery • Augen-Instrumentarium • Oftalmologia
- Chirurgie ophtalmologique • Oftalmologia

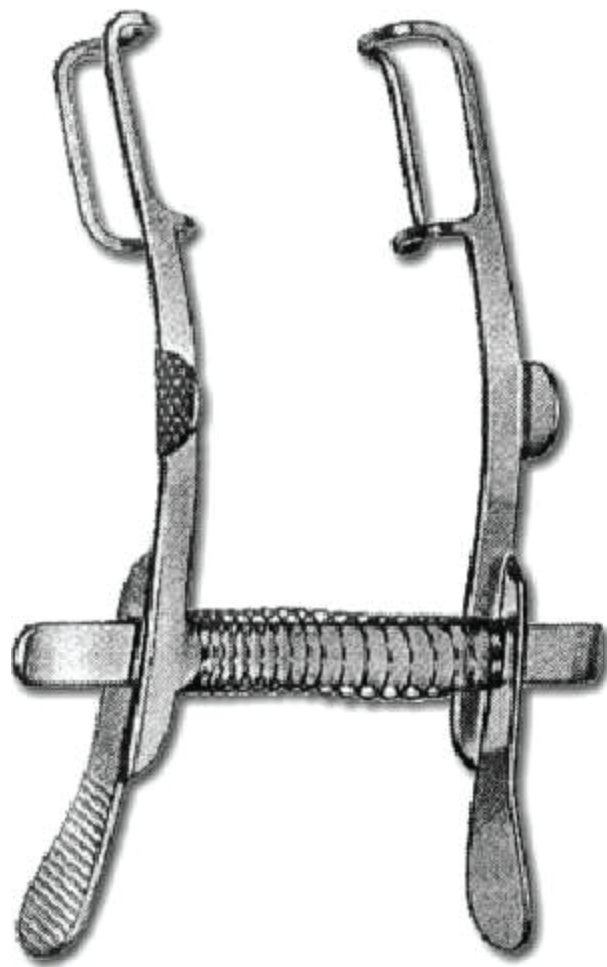

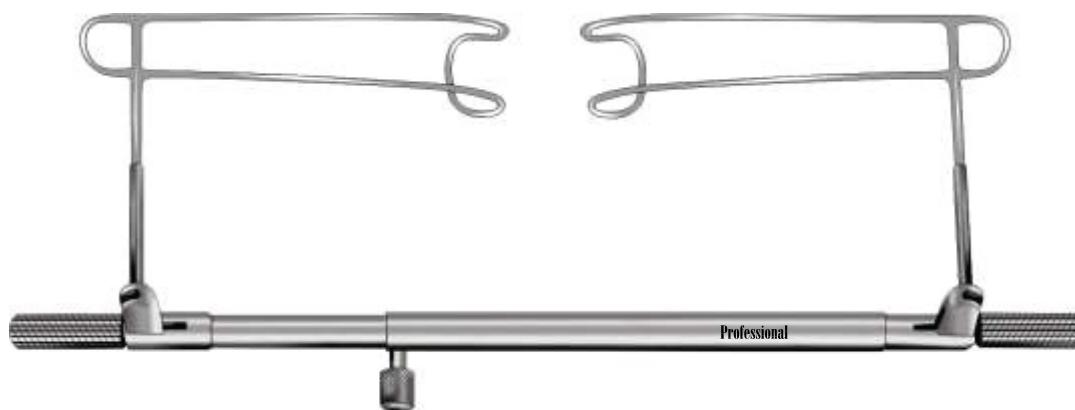

Schott Eye Speculum

Fenestrated, individually adjustable blades for controlled lid elevation

PAB-100.01 Adult Size

PAB-100.02 Child Size



Blefarostatos

Schott Eye Speculum

With solid, individually adjustable blades for controlled lid elevation

PAB-102.01 Adult Size

PAB-102.02 Child Size

Weiss Eye Speculum
With open blades
PAB-104.06

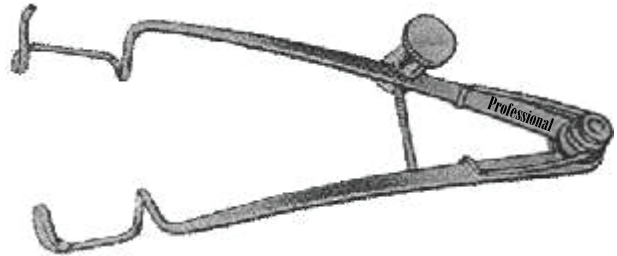

Weiss Eye Specula Large
With fenestrated blades
PAB-105.07

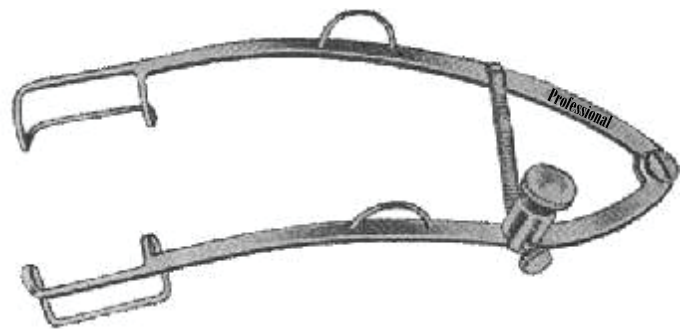

Weiss Eye Specula small
With fenestrated blades
PAB-106.06

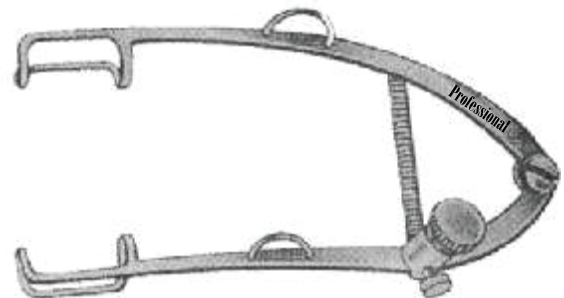

Weiss Eye Specula large
With solid blades
PAB-107.09

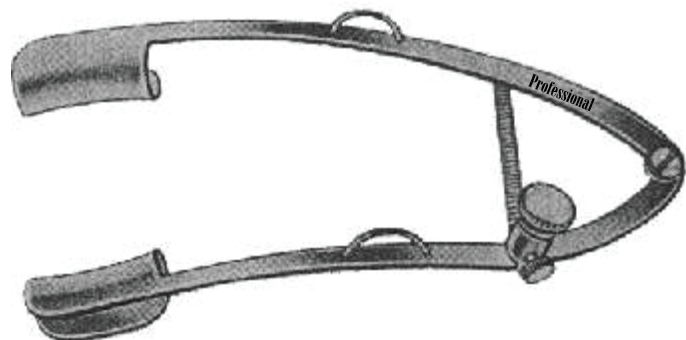

Weiss Eye Specula small
With solid blades
PAB-108.08

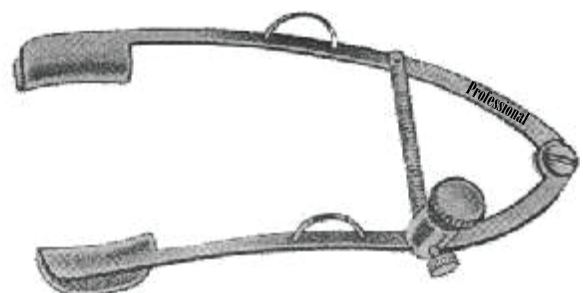

Lester-Burch Eye Specula
With locking screw, solid blades
PAB-109.14

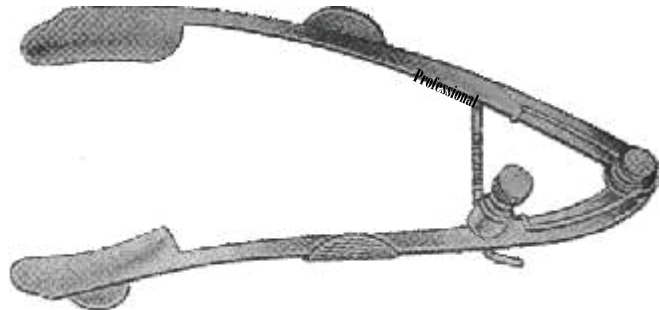

Lancaster Eye Specula
With locking screw, solid blades
PAB-110.06

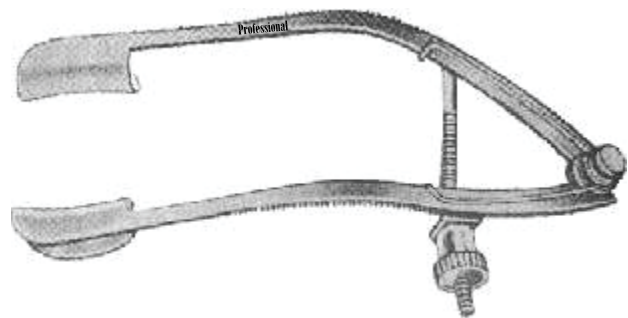

Castroviejo Eye Specula
PAB-111.14 Small (14 mm blades)
PAB-112.16 Medium (16 mm blades)
PAB-113.18 Large (18 mm blades)



Mellinger-Beard Eye Specula
With solid blades
PAB-114.01 Child size
PAB-114.02 Adult size

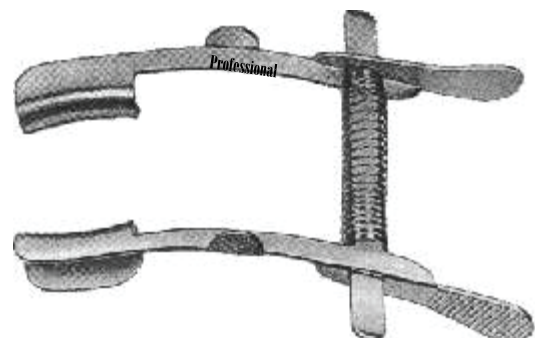

Mellinger Eye Speculum
With fenestrated blades
PAB-115.01 Child size
PAB-116.02 Adult size

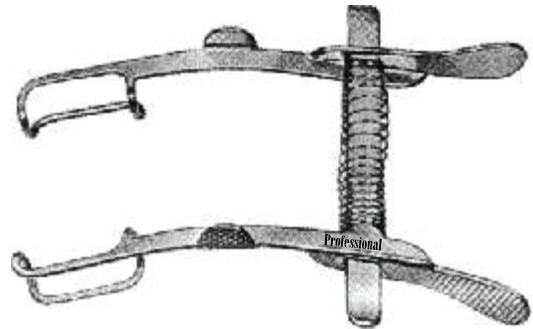

Cook Eye Speculum
Infant size
PAB-117.01

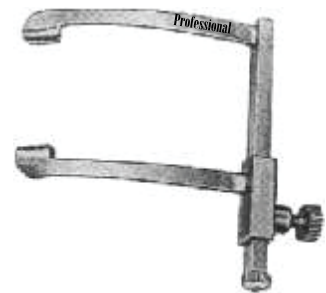

Cook Eye Speculum
Child size
PAB-118.02

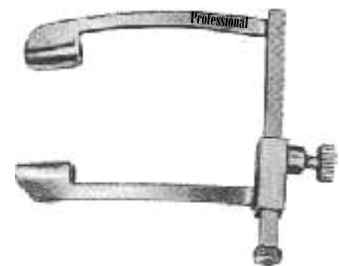

Cook Eye Speculum
Adolescent size
PAB-119.03

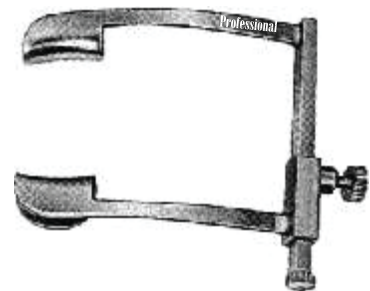

Cook Eye Speculum
Adult size
PAB-120.04

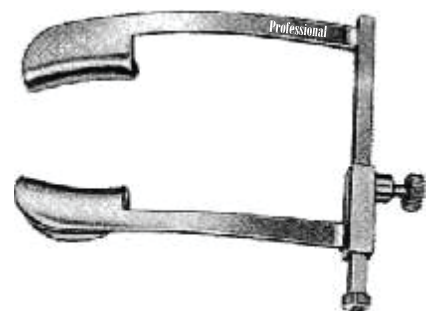

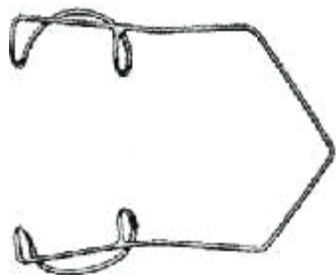

Barraquer Eye Speculum

Fenestrated round blades

PAB-121.14 Adult size (14 mm wide)

PAB-122.10 Child size (10 mm wide)

PAB-123.05 Infant size (5 mm wide)

PAB-124.03 premature (3 mm wide)



Barraquer Eye Speculum

Fenestrated blades

PAB-122.15 Adult size (15 mm wide)

PAB-122.10 Child size (10 mm wide)

PAB-122.05 Infant size (5 mm wide)

PAB-122.03 Premature (3 mm wide)



Barraquer Eye Speculum

Solid blades

PAB-123.15 Adult size (15 mm wide)

PAB-124.10 Child size (10 mm wide)

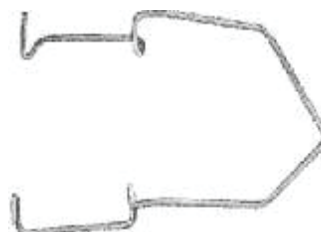

Kratz - Barraquer Eye Speculum

Open blades

PAB-125.01 Adult size

PAB-126.02 Child size

PAB-127.03 Heavy 1 mm model

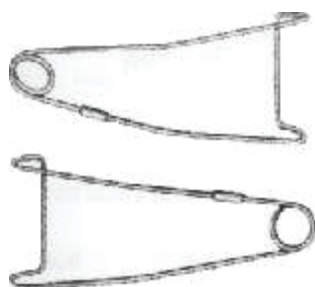

Jaffe Lid Retractor

With fenestrated blade, may be clamped to surgical drape with suture or elastic band

PAB-128.14 Adult size (14 mm wide)

PAB-129.10 Child size (10 mm wide)



Tennant Lid Retractor

With solid blade, may be clamped to surgical drape with suture or elastic band

PAB-130.14 Adult size (14 mm wide)



Clayman Lid Retractor (set of two)

Mobile, fenestrated blade may be clamped to surgical drape with suture or elastic band

PAB-131.14 Adult size (14 mm wide)



Sauer Lid Speculum

Self-retaining, with solid blades

PAB-132.10 Child size (10 mm wide)

PAB-133.06 Infant size (6 mm wide)

PAB-134.04 Premature (4 mm wide)

Murdoch Eye Speculum

With large fenestrated blades
PAB-135.01 Right model
PAB-136.02 Left model

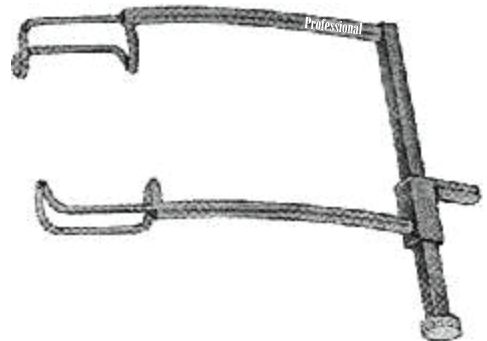

Clark Eye Speculum

With adjustment screw and open blades
PAB-137.08

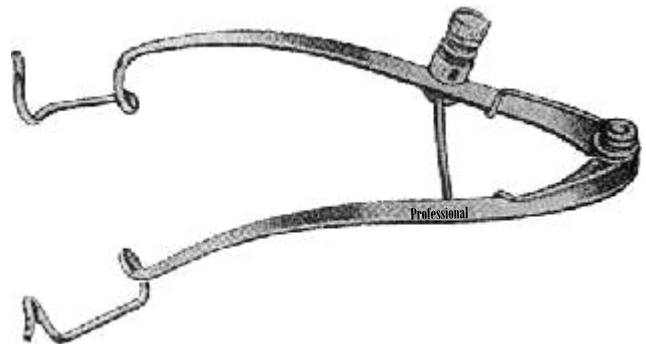

Maumee - Park Eye Speculum

Mobile fenestrated blades with locking screw and hooked enter blade
PAB-138.01

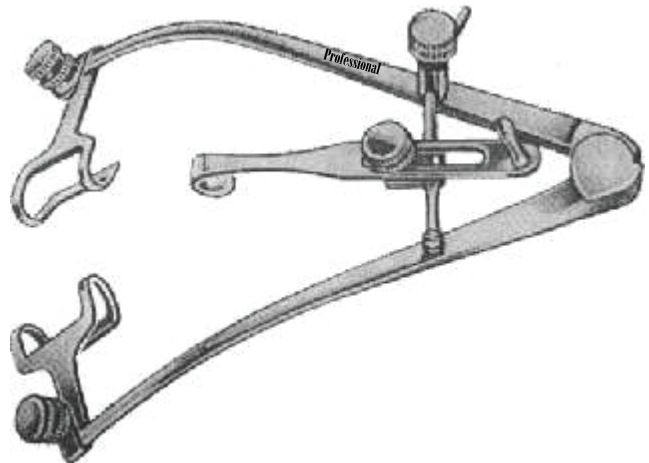

Park - Guyton Eye Speculum

Mobile fenestrated blades with vertical suture posts and hooked center blade
PAB-139.02

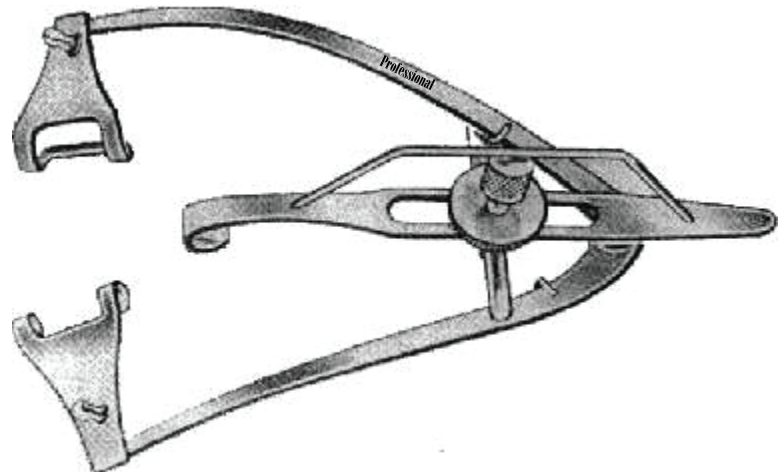



Castroviejo Lid clamp
With locking screw, solid blades
PAB-140.09
Jaeger Lid Plate
Stainless steel
PAB-141.08



Klar Lid Everter
Open
PAB-142.12



Desmar res Lid R etractor
With solid blade (standard pattern)
PAB-143.08 8 mm wide (Conway)
PAB-144.10 10 mm wide # 0
PAB-145.12 12 mm wide # 1
PAB-146.14 14 mm wide # 2
PAB-147.16 16 mm wide # 3
PAB-148.18 18 mm wide # 4



Desmarres Lid Retractor
With fenestrated blade (new pattern)
PAB-149.12 12 mm wide # 1
PAB-150.14 14 mm wide # 2

Professional

- Eye surgery • Augen-Instrumentarium • Oftalmologia
- Chirurgie ophtalmologique • Oftalmologia





PAB-151.03
Scalpel Handle No. 3



PAB-152.07
Scalpel Handle No. 7K



Scalpel Blade Fig. 11
sterile, box of 100 pcs



Scalpel Blade Fig. 15
sterile, box of 100 pcs



Disposable Scalpel No. 11 with Plastic Handle
sterile, package of 10 pieces



Disposable Scalpel No. 15 with Plastic Handle
sterile, package of 10 pieces

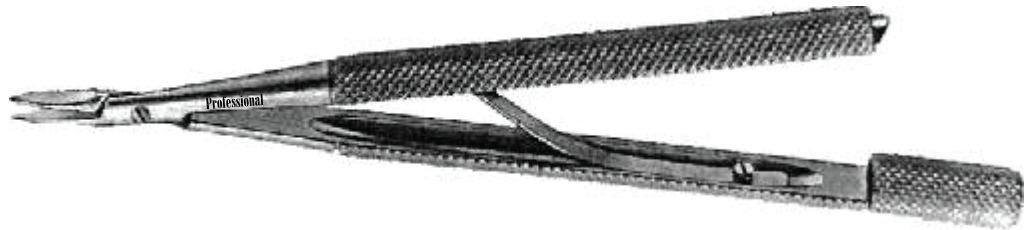

Castroviejo Razor Blade Holder
Overall length 130 mm with 8 mm handle
PAB-153.00



Castroviejo Razor Blade Holder
With 6 mm handle
PAB-154.90 Overall length 90 mm
PAB-155.12 Overall length 120 mm



Troutman Razor Blade Holder Straight
Overall length 95mm
PAB-156.95



Troutman Razor Blade Holder angled
Overall length 90mm
PAB-157.90



Barraquer Razor Blade Holder
Overall length 110 mm
PAB-158.11

Professional

- Eye surgery • Augen-Instrumentarium • Oftalmologia
- Chirurgie ophtalmologique • Oftalmologia





Knapp Discission Knife
Overall Length 120mm
PAB-159.50 5,0 mm blade
PAB-160.60 6,0 mm blade
PAB-161.70 7,0 mm blade



Ziegler Discission Knife
Overall Length 115mm
PAB-162.20 2,0 mm blade
PAB-163.30 3,0 mm blade
PAB-164.50 5,0 mm blade
PAB-165.60 6,0 mm blade

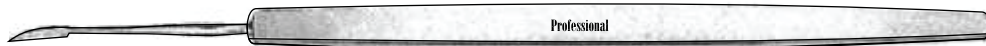

Wecker Discission Knife
Overall Length 125mm
PAB-166.12 Double adge



Swiss Pattern Discission Knife
Overall Length 120mm
PAB-167.12



Wheeler Discission Knife
Overall Length 115mm
PAB-168.18 18 mm cutting edge



Barkan Goniotomy Knife
Overall Length 120mm
PAB-169.12



Schele Goniotomy Knife
Overall Length 125mm
PAB-170.12



Graefe Straight Cataract Knife

Overall length 130mm

PAB-171.15 1,5 x 25 mm

PAB-172.20 2,0 x 30 mm

PAB-173.23 2,3 x 33 mm



Graefe Cystotome Knife

Overall length 125mm, malleable shaft with 1,5 mm cutting edge

PAB-174.12



Hamburg Air Keratome

Overall length 125mm, 12 mm, long 45dg angled blade with sharp tip and cutting edges

PAB-175.12



Bonn Scleral Resection Knife

Overall length 125mm

PAB-176.04 4 mm blade

PAB-177.07 7 mm blade



Professional

Tooke Corneal Knife

Overall length 115 mm, smooth blade with curved cutting edges

PAB-178.11 3 x 18 mm blade



Paufigue Graft Knife

Overall length 105 mm, angled tip curved cutting edge

PAB-179.10



Cataract Knife

Overall length 135mm

PAB-180.23 Blade 32 x 2,3 mm

PAB-181.26 Blade 35 x 2,6 mm

PAB-182.30 Blade 35 x 3,0 mm



Deuschmann Cataract Knife

Overall Length 135mm

PAB-183.13



Jaeger Keratome Angled

Overall length 135mm

PAB-184.10 10 x 10 mm

PAB-185.11 11 x 11 mm

PAB-186.12 12 x 12 mm

PAB-187.13 13 x 13 mm



Jaeger Keratome Straight

Overall Length 135mm

PAB-188.10 10 x 10 mm

PAB-189.11 11 x 11 mm

PAB-190.12 12 x 12 mm

PAB-191.13 13 x 13 mm



Castroviejo Keratome Angled

Overall Length 135mm

PAB-192.13 4 x 13 mm



Jameson Muscle Hook

Overall length 140 mm

PAB-193.01 Delicate

PAB-194.02 Small

PAB-195.03 Large



Graefe Strabismus Hook

PAB-196.01 # -1 small

PAB-197.02 # 2 medium

PAB-198.03 # 3 large



Stevens Tentomy Hook

Overall Length 120 mm, blunt 6mm curved tip

PAB-199.12



Gass Retinal Detachment Hook

Overall length 140 mm, flat tip with oval hole

PAB-200.14



Burch Fixation Pick

Overall length 130 mm, with ball stop

PAB-201.13



Twist Fixation Hook

Overall length 120 mm, for scleral fixation

PAB-202.12R Right

PAB-203.12L Left



Tyrell Iris Hook

Overall length 125 mm

PAB-204.12 Sharp

PAB-205.12 Blunt

Professional

- Eye surgery • Augen-Instrumentarium • Oftalmologia
- Chirurgie ophtalmologique • Oftalmologia





Snellen Lens Loop
Overall length 140mm
PAB-210.14 15 x 4 mm smooth loop



Wilder Lens Loop
Overall length 140mm
PAB-211.14 15 x 4 mm serrated loop



Keener - Arlt Lens Nucleus Loop
Strong curved 3mm wide serrated loop for small incision
nucleus fragment removal
PAB-212.03



Kansas Lens Nucleus Loop
Light curved 3 mm wide serrated loop for small incision
nucleus fragment removal
PAB-213.03



Lewis Lens Loop
PAB-214.01 Small
PAB-215.02 Large



Morrison Lens Loop and Probe
Very thin loop and delicate olive tip
PAB-216.02



Kirby Lens Loop and Expressor Hook
Overall length 145 mm
PAB-217.14



Simcoe Lens Nucleus Loop
Overall length 110 mm, finely serrated on top loop
PAB-218.11

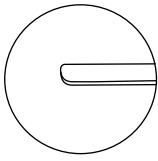

Knolle Lens Nucleus Spatula
Overall Length 120 mm, flat 0,5 mm wide blade
PAB-219.12

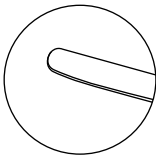

Sinsky Lens Nucleus Spatula
Overall length 120 mm, slightly curved 30 mm long narrow blade
PAB-220.12

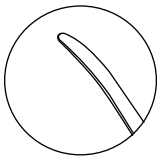

Girard Synechia Spatula
Overall length 115 mm, 0,5 mm wide 10mm vaulted blade
PAB-221.11

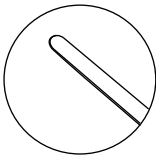

Jaffe Lens Spatula
Overall length 115mm, smooth 0,5mm wide 10 mm angled blade
PAB-222.11

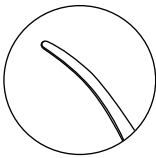

Johnson Sideport Nucleus Spatula
Overall length 115mm, 0,25 mm wide blade, 10 mm vaulted shaft with sharp tip
PAB-223.11

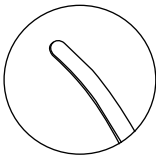

Birnbaum Lens Spatula
Overall length 120 mm, 0,25 mm wide 10 mm vaulted blade
PAB-224.12

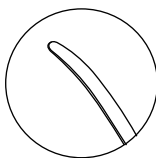

Hirschmann Lens Spatula
Overall length 115 mm, flat 0,5 mm wide 10 mm angled blade
PAB-225.11

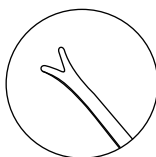

Lippman Sideport Nucleus Spatula
Overall length 115 mm, 0,5 mm wide blade 10 mm vaulted shaft with blunt forked tip
PAB-226.11



Barraquer Iris Spatula
Overall length 120 mm, 0,5 mm round blade with smooth pointed tip
PAB-227.07 7 mm angled
PAB-228.10 10 mm angled
PAB-229.15 15 mm angled



Elschnig Cyclodialysis Spatula
Overall length 135 mm, 1,0 mm wide flat blade
PAB-230.13 12 mm angled



Castroviejo Cyclodialysis Spatula
Overall length 135 mm, with 1,0 mm wide flat blade
PAB-231.10 10 mm angled
PAB-232.15 15 mm angled



Castroviejo Cyclodialysis Spatula
Overall length 135 mm, double - ended 10 and 15 mm long blade with smoothly pointed tips
PAB-233.50 0,50 mm wide blade
PAB-234.75 0,75 mm wide blade
PAB-235.99 1,00 mm wide blade



Paton Spatula and Spoon
Overall length 140mm
PAB-236.14



Wheeler Cyclodialysis Spatula

Overall length 135mm, 1,75 mm wide blades

PAB-237.13 Stainless steel

PAB-238.13 Sterling silver



Wecker Iris Spatula

Overall length 135mm, delicate 0,5 mm wide blade

PAB-239.13



Wecker Iris Spatula

Overall length 135mm, small 1,0 mm wide blade

PAB-240.10 Stainless steel

PAB-241.10 Sterling silver



Wecker Iris Spatula

Overall length 135mm, 2,0 mm wide blade

PAB-242.13 Stainless steel

PAB-243.13 Sterling silver



Kimura Platinum Spatula

Overall length 145mm, with wide ultra thin, flat blade

PAB-244.14



Sautter Orbital Spatula

Overall length 145mm, angled concave curved blade

PAB-245.12 12 mm wide blade

PAB-246.15 15 mm wide blade

PAB-247.18 18 mm wide blade



Meyhöfer Chalazion Curette

Overall length 130 mm, sharp round cup

PAB-248.05 ø 0.50 mm

PAB-249.10 ø 1.00 mm

PAB-250.15 ø 1.50 mm

PAB-251.17 ø 1.75 mm

PAB-252.20 ø 2.00 mm

PAB-253.25 ø 2.50 mm

PAB-254.30 ø 3.00 mm

PAB-255.35 ø 3.50 mm



Hebra Chalazion Curette

Overall length 130 mm, sharp oval cup

PAB-255.10 ø 1.00 mm

PAB-257.20 ø 2.00 mm

PAB-258.25 ø 2.50 mm

PAB-259.30 ø 3.00 mm

PAB-260.35 ø 3.50 mm



Axenfeld Chalazion Curette

Overall length 145 mm double ended

PAB-261.14



Bunge Enucleation Curette

Overall length 145 mm, with round sharp spoon

PAB-262.05 ø 6 mm

PAB-263.08 ø 8 mm

PAB-264.10 ø 10 mm

PAB-265.12 ø 12 mm



Gillis- Welsh Capsule Polishing Curette

Overall length 125 mm, 8 mm backward angled

PAB-266.12 ø 1.5 mm



Daviel Lens Spoon

Overall length 135 mm, light curved, small spoon

PAB-267.13 stainless steel



Daviel Lens Spoon

Overall length 135 mm, light curved, large spoon

PAB-268.13 stainless steel

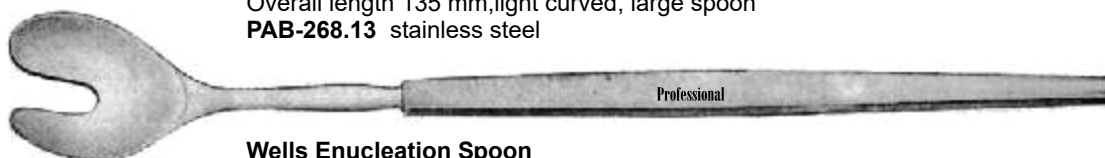

Wells Enucleation Spoon

Overall length 145 mm, 21 mm wide blade with notch

PAB-269.14

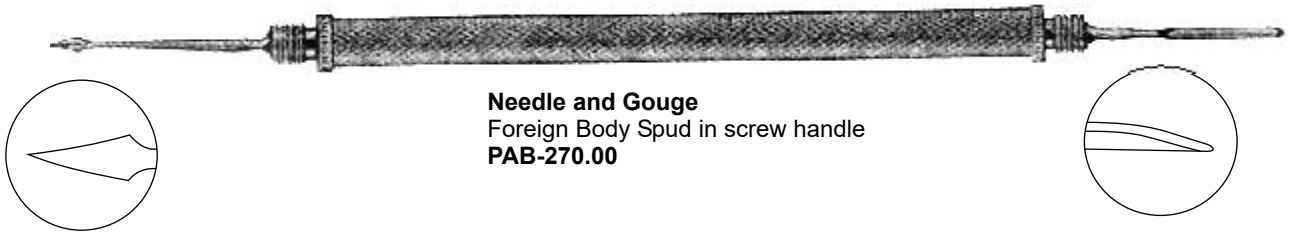

Needle and Gouge
Foreign Body Spud in screw handle
PAB-270.00

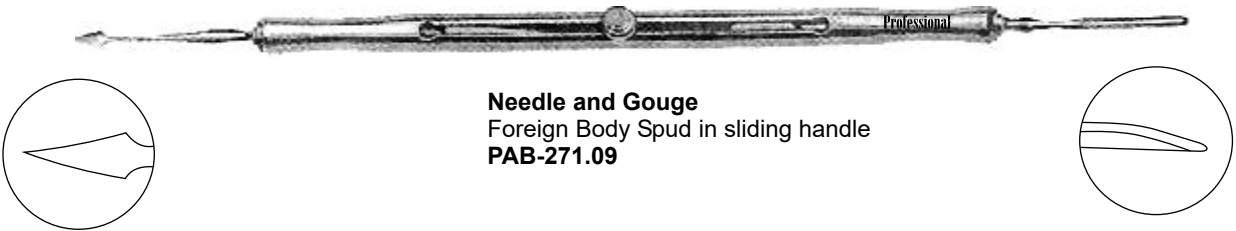

Needle and Gouge
Foreign Body Spud in sliding handle
PAB-271.09



Ellis Foreign Body Spud
Overall length 120mm, very thin lightly curved
round tip
PAB-272.12



Francis Foreign Body Spud
Overall length 120mm, flag shaped angled
tip with sharp edge
PAB-273.12



Dezel Foreign Body Needle
Overall length 120mm, sharp spear tip
PAB-274.12 Straight
PAB-275.12 Curved



Golf Club Foreign Body Spud
Overall length 115mm, angled lightly rounded
with sharp edge
PAB-276-11

Chalazion Curettes
 Chalazionsloffel
 Cucharillas Para Chalazion
 Curettes Trachantes A Chalazion

• Eye surgery • Augen-Instrumentarium • Oftalmologia

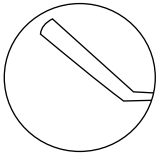

Kansas Nucleus Vectis
 Overall length 115 mm, cutting board for
 Kansas nucleus bisector and trisector
PAB-280.01 For right handed surgeons
PAB-280.02 For left handed surgeons

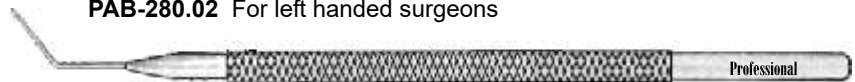
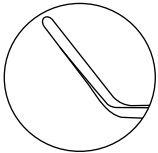

Kansas Nucleus Bisector
 Overall length 110 mm, 10 mm angled blade with semi - sharp cutting edge
 on the vertical plane, to divide the nucleus in two parts
PAB-281.01

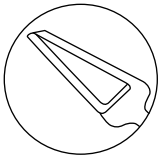

Kansas Nucleus Trisector
 Overall length 110 mm
PAB-282.01 For right handed surgeons
PAB-282.02 For left handed surgeons

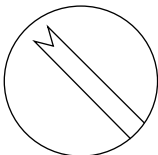

Clayman Nucleus Rotator
 Overall length 115 mm, V- Notched 10 mm angled tip
PAB-284.11 Flat 0,5 mm Wide blade

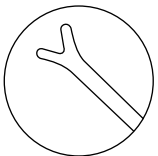

Jaffe-Bechert Lens Nucleus Rotator
 Overall length 115 mm, 9 mm angled
PAB-286.11 Blunt forked tip

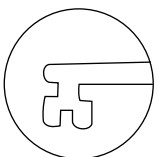

Osher Nucleus Manipulator
 Overall length 125 mm, with 0,5 mm two - prong tip
PAB-287.12 Straight
PAB-287.22 Angled

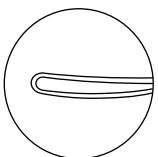

Kansas Nucleus Loop
 Overall length 135 mm, light curved 3 mm wide serrated loop
PAB-288.13

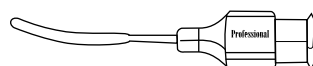
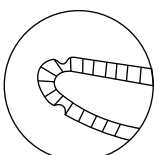

Gruber - Hofmann Irrigating Vectis
 25 ga x 3 mm wide serrated loop with two front ports
PAB-290.25

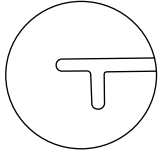

Fenzl Lens Manipulating Hook

Overall length 120 mm 0,15 mm blunt T-Shaped tip,

PAB-292.01 Straight

PAB-292.02 Angled

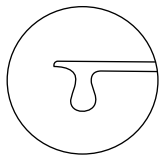

Lester Lens Pusher

Overall length 115 mm straight shaft with \varnothing 0,25 mm,
hour-glass shaped tip

PAB-293.11

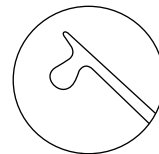

Lester Lens Pusher

Overall length 115 mm angled shaft with \varnothing 0,25 mm
hour-glass shaped tip

PAB-294.11

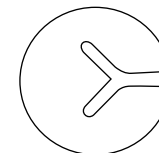

Osher Lens Manipulator

Overall length 115 mm, Y-shaped Hook

PAB-296.11 Straight

PAB-297.11 Angled

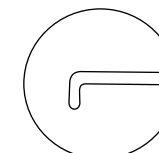

Jaffe IOL Manipulating Hook

Overall length 125mm, blunt tip with 0,15 mm

PAB-298.12 Straight

PAB-299.12 Angled

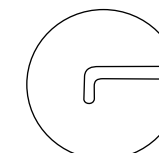

Sinsky II IOL Manipulating Hook

Overall length 125mm, blunt tip 0,2 mm

PAB-300.12 Straight

PAB-301.12 Angled

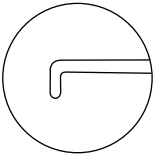

Sinsky II IOL Manipulating Hook
Overall length 115 mm, blunt tip
PAB-302.11 Straight 0,2 mm

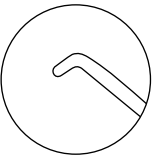

Lewicky IOL Manipulating Hook
Overall length 125 mm, blunt tip
PAB-304.12 0,15 mm

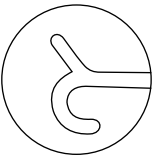

Rentsch Manipulating Hook and Iris Retractor
Overall length 115 mm, blunt boat hook-like tip
PAB-305.11

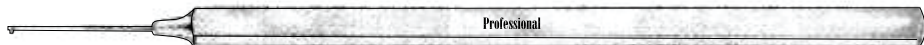
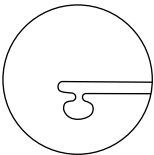

Kuglen Lens Manipulator and Iris Hook
Overall length 120 mm, ball-like tip
PAB-306.12

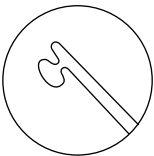

Kuglen Lens Manipulator and Iris Hook
Overall length 120 mm, angled ball-like tip
PAB-307.12

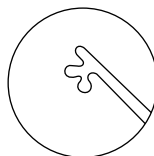

Kuglen Lens Manipulator and Iris Hook
Overall length 120 mm,
PAB-308.12 Straight
PAB-309.12 Angled

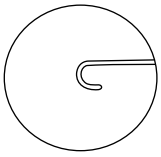

Bonn Micro Iris Hook

Overall length 120 mm very delicate 0,3 mm blunt hook

PAB-310.12 Straight

PAB-310.22 Angled

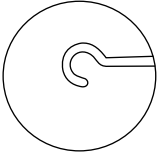

Knolle Iris Hook

Overall length 120 mm, delicate 0,3 mm blunt hook

PAB-311.12 Straight

PAB-312.12 Angled

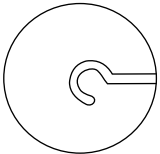

Shepard Iris Hook

Overall length 120 mm small 1,0 mm blunt hook

PAB-313.12 Straight

PAB-313.22 Angled

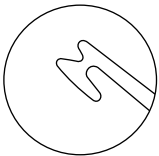

Hirschmann Iris Hook

Overall length 120 mm, blunt 0,75 mm hook

PAB-314.12

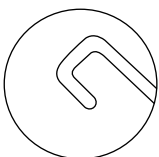

Osher Iris Hook

Overall length 120 mm, blunt 1,5 mm hook

PAB-316.12

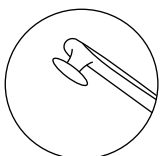

Greather Multi-function Instrument

Overall length 125 mm

PAB-317.12 Straight

PAB-317.22 Angled

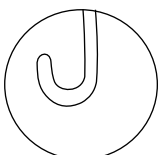

Osher Micro Suture Hook

Overall length 120 mm

PAB-318.12

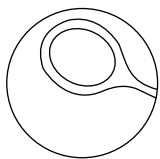

Nordan Capsule Elevator
Overall length 115 mm, angled shaft with delicate ring
PAB-319.11

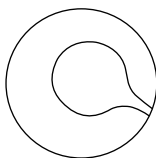

Anis Capsule Scrubber
Overall length 115 mm, with ball shaped tip
PAB-320.11

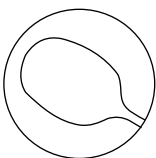

Anis Capsule Scrubber
Overall length 115 mm, with disc shaped tip
PAB-321.11

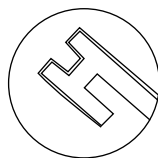

Mackool Capsule Retractor
Overall length 120 mm, 1,0 mm blunt hook with suspend 0,5 mm from end of tip
PAB-322.12

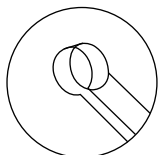

Maro Polishing Ring Curette
Overall length 105 mm, 45 dg angled shaft with 1,5 mm Semi - sharp open ring
PAB-323.10

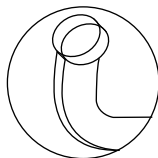

Maro Polishing Ring Curette
Overall length 105 mm, 90 dg angled shaft with 1,5 mm semi-sharp open ring
PAB-324.10

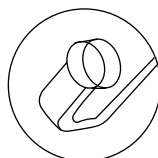

Maro Polishing Ring Curette
Overall length 105 mm, 180 dg backward angled shaft with 1,5 mm semi-sharp open ring
PAB-326.10

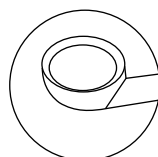

Gills-Volker Capsule Polishing Curette
Overall length 105 mm, gently backward angled shaft with Ø1,5 mm sharp cup
PAB-327.10

Professional

- Eye surgery • Augen-Instrumentarium • Oftalmologia
- Chirurgie ophtalmologique • Oftalmologia

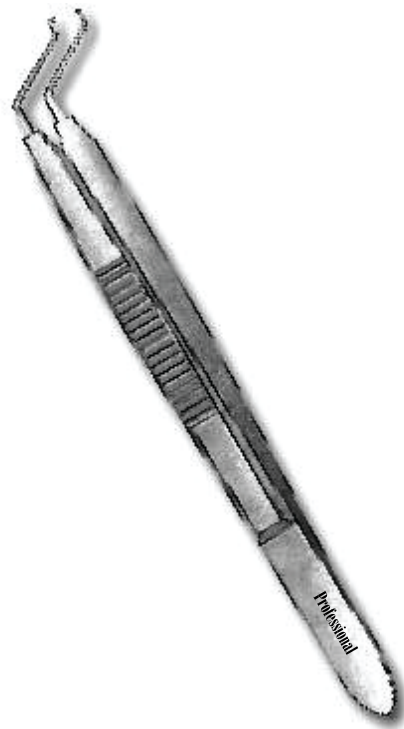

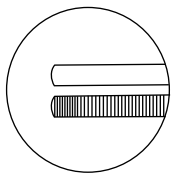

Straight Dressing Forceps with serration

Overall length 100 mm

PAB-330.05 0,5 mm wide tips

PAB-330.07 0,7 mm wide tips

PAB-330.10 1,0 mm wide tips

PAB-330.12 1,2 mm wide tips

PAB-330.14 1,4 mm wide tips

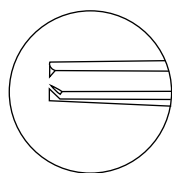

Straight Tissue Forceps with 1 x 2 teeth

Overall length 100 mm

PAB-332.05 0,5 mm wide tips

PAB-332.07 0,7 mm wide tips

PAB-332.10 1,0 mm wide tips

PAB-332.12 1,2 mm wide tips

PAB-332.14 1,4 mm wide tips

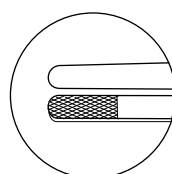

Bishop Harmon Dressing Forceps

Overall length 85 mm criss-cross serrated

PAB-333.06 0,6 mm wide tips

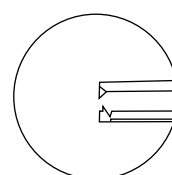

Bishop Harmon Tissue Forceps

Overall length 85 mm 1 x 2 teeth

PAB-334.06 Delicate 0,6 mm wide tips



Gently curved Dressing Forceps with serration
Overall length 100 mm gently curved tips
PAB-335.07 0,7 mm wide tips



Gently curved Tissue Forceps with 1 x 2 teeth
Overall length 100 mm gently curved tips
PAB-336.07 0,7 mm wide tips



Strong Curved Dressing Forceps with serration
Overall length 100 mm strong curved tips
PAB-337.07 0,7 mm wide tips



Strong curved Tissue Forceps with 1 x 2 teeth
Overall length 100 mm Strong curved tips
PAB-338.07 0,7 mm wide tips

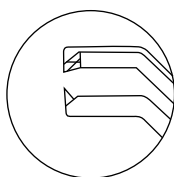

Angled Hess Iris Forceps Swiss pattern
1 x 2 teeth, overall length 100 mm
PAB-339.10

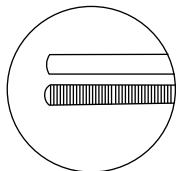

Straight Graefe Iris Forceps

Fine serrated, overall length 65 mm

PAB-340.05 0,5 mm wide shanks

PAB-340.07 0,7 mm wide shanks

PAB-340.10 1,0 mm wide shanks

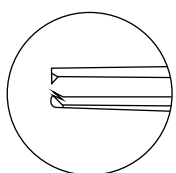

Straight Graefe Tissue Forceps

1 x 2 teeth, overall length 65 mm

PAB-341.05 0,5 mm wide shanks

PAB-341.07 0,7 mm wide shanks

PAB-341.10 1,0 mm wide shanks

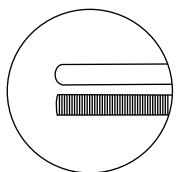

Curved Graefe Iris Forceps

1 x 2 teeth, overall length 65 mm

PAB-342.05 0,5 mm wide shanks

PAB-342.07 0,7 mm wide shanks

PAB-342.10 1,0 mm wide shanks

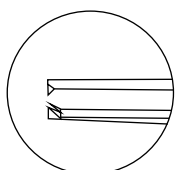

Curved Graefe Tissue Forceps

1 x 2 teeth, overall length 65 mm

PAB-344.05 0,5 mm wide shanks

PAB-344.07 0,7 mm wide shanks

PAB-344.10 1,0 mm wide shanks

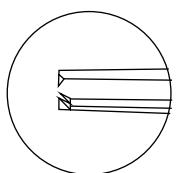

Straight Bonn Micro Iris Forceps

0,12 mm 1x2 teeth, without tying platform

PAB-345.75 Overall length 75 mm

PAB-345.95 Overall length 95 mm

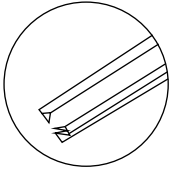

Angled Bonn Micro Iris Forceps

Angled 40 dg 0,12 mm 1 x 2 teeth, without tying platform
Overall length 72 mm

PAB-346.72

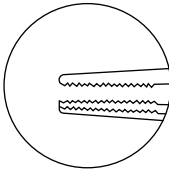

Straight Bonn Micro Iris Forceps

Ultra fine shaft with micro serrations,
Overall length

72 mm

PAB-347.72

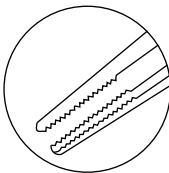

Angled Bonn Micro Iris Forceps

Angled 40 dg ultra fine shaft with micro serrations,
Overall length 72 mm

PAB-348.72

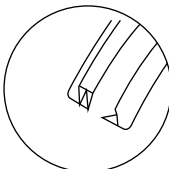

Strong Curved Graefe Tissue Forceps

1 x 2 teeth, overall length 75 mm

PAB-349.75

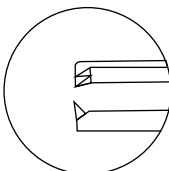

Straight Iris Tissue Forceps

1 x 2 teeth, overall length 75 mm

PAB-350.75

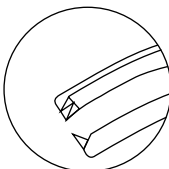

Curved Iris Forceps Swiss pattern

1 x 2 teeth, overall length 100 mm

PAB-351.10

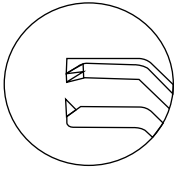

Hess-Engelking Iris Forceps angled
Overall length 72 mm
PAB-352.72 1 x 2 teeth

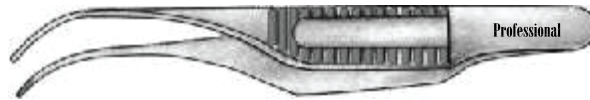
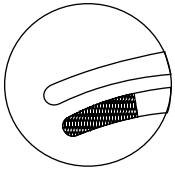

Gill Iris Forceps curved
Overall length 75 mm
PAB-353.10 Cross - serrated
PAB-353.11 1 x 2 teeth

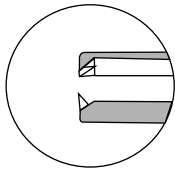

Iris Forceps Zuerich pattern
Overall length 70 mm Extremely delicate
PAB-354.70 1 x 2 teeth

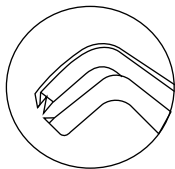

Botvin Iris Forceps double curved
Overall length 70 mm
PAB-355.03 Serrated
PAB-355.04 1 x 2 teeth



Graefe Fixation Forceps without lock

Overall length 110 mm

PAB-356.35 Narrow, 3,5 mm jaws

PAB-356.45 Wide, 4,5 mm jaws



Graefe Fixation Forceps with lock

Overall length 110 mm

PAB-357.45 Wide 4,5 mm teeth



Jess Fixation Forceps

Overall length 110 mm

PAB-358.11



Barraquer Fixation Forceps

Overall length 100 mm

PAB-359.10



Barraquer-Llobera Fixation Forceps

Overall length 95 mm

PAB-360.95

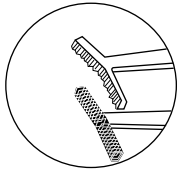

Green Fixation Forceps

Overall length 100 mm Multiple teeth

PAB-362.05 5,0 mm

PAB-362.10 10,0 mm

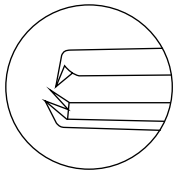

Elschnig Fixation Forceps

Overall length 105 mm 1 x 2 angular teeth

PAB-363.03 0,3 mm

PAB-363.09 0,9 mm

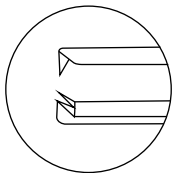

Lester Fixation Forceps straight

Overall length 95 mm 0,6 mm teeth

PAB-364.12 1 x 2 teeth

PAB-364.23 2 x 3 teeth

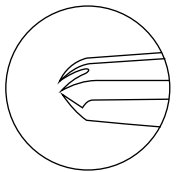

Kuhnt Fixation Forceps

Overall length 110 mm straight shafts with curved

1 x 2 teeth

PAB-366.11

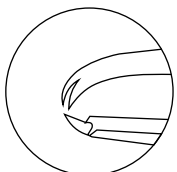

Bracken Scleral Fixation Forceps

Overall length 105 mm straight shafts with

delicate 0,7 mm, 1x2 teeth

PAB-368.10

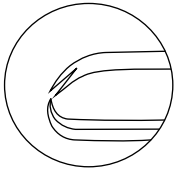

Farkas Bracken Corneal Fixation Forceps

Overall length 105 mm straight shaft with delicate
 0,12mm, 1x2 teeth

PAB-370.10

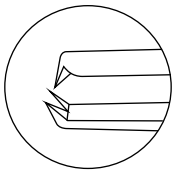

Troutman Superior Rectus Forceps

Overall length 105 mm 45 dg angled shaft, 10 mm
 from tip to bend, 1x2 teeth

PAB-372.10

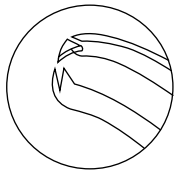

Tennant-Troutman Superior Rectus Forceps

Overall length 105 mm curved shanks 1x2 teeth

PAB-374.10

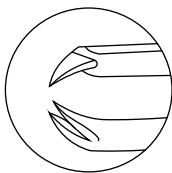

Sauer Suturing Forceps

Overall length 90 mm straight shaft with 1x2
 angled teeth

PAB-376.90

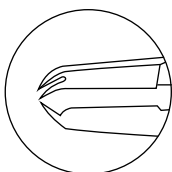

Manhattan Eye & Ear Forceps

Overall length 90 mm straight shaft with 1x2 teeth
 6mm long tying platform

PAB-378.90

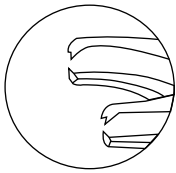

Kremer Corneal Fixation Forceps straight

Overall length 110 mm, with 2 point fixation, tips separated by 13mm 1x2 teeth each tip 0,12 mm, with catch lock
PAB-380.11

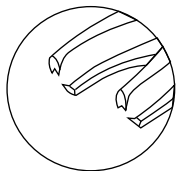

Kremer Corneal Fixation Forceps angled

Overall length 110 mm, with 2 point fixation, tips separated by 13mm 1x2 teeth each tip 0,12mm, with catch lock
PAB-382.11

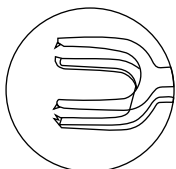

Bores Corneal Fixation Forceps Straight

Overall length 103 mm, with 2 point fixation, tips separated by 3 mm 1x2 teeth each tip 0,12 mm
PAB-383.10

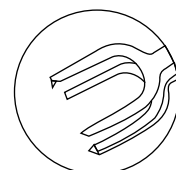

Rubman-Bores Corneal Fixation Forceps Curved.

Overall length 103 mm, with 2 point fixation, tips separated by 3 mm 1x2 teeth each tip 0,12 mm
PAB-384.10

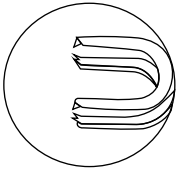

Arrowsmith Corneal Fixation Forceps Straight

Overall length 107mm, with 2 point fixation, tips serrated by 8mm 1x2 teeth each side 0,12 mm with catch
PAB-386.10

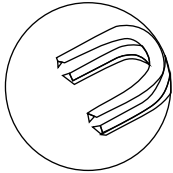

Arrowsmith Corneal Fixation Forceps Curved

Overall length 107mm, with 2 point fixation, tip serrated by 8mm 1x2 teeth each side 0,12 mm with catch
PAB-387.10

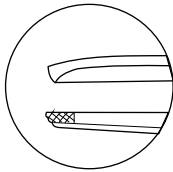

Bonaccolto Conjunctiva Forceps

Overall length 110 mm with 16mm long platform serrated jaws and cross serrated tips
PAB-390.11 1,2 mm wide
PAB-390.12 1,7 mm wide
PAB-390.13 2,4 mm wide

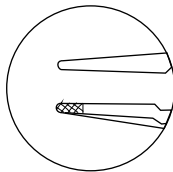

McGregor Conjunctiva Forceps

Overall length 110 mm with 5 mm long tying platform criss-cross serrated tips
PAB-392.11

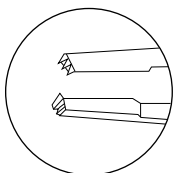

Thorpe Conjunctiva Forceps

Overall length 95 mm with tying platform and 2x3 teeth 0, set at 90 dg
PAB-394.95

• Eye surgery • Augen-Instrumentarium • Ophthalmologia

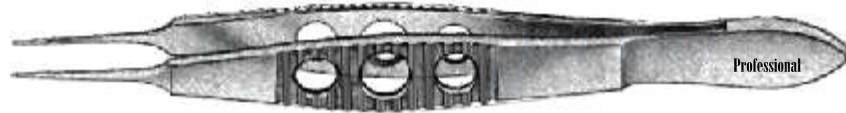
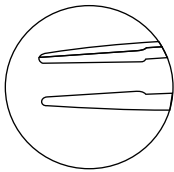

Jaffe Tying Forceps

Overall length 100 mm, very delicate smooth jaws with 6mm long platform for 8-0 to 11-0 sutures

PAB-396.10 Straight

PAB-396.11 Curved

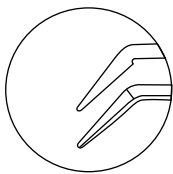

Dardenne Tying Forceps angled

Overall length 100 mm extra delicate 7 mm long angled platform for 9-0 to 11-0 sutures

PAB-398.10

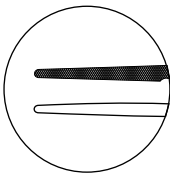

Tennant Tying Forceps with Pin

Overall length 100 mm with guide pin and extra delicate 6 mm long platform for 9-0 to 11-0 sutures

PAB-400.10 Straight

PAB-400.11 Curved

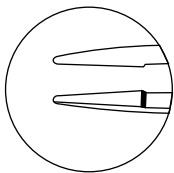

Harms-Tuebingen straight Tying Forceps

Overall length 100 mm with 6 mm long platform for 7-0 to 9-0 sutures

PAB-402.01 Straight

PAB-402.02 Curved

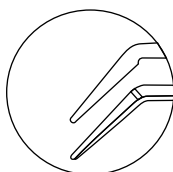

Harms - Tuebingen Tying Forceps angled

Overall length 110mm with 7 mm long delicate angled platform for 7-0 to 9-0 sutures

PAB-403.11

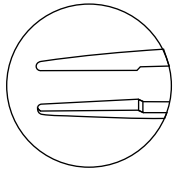

Troutman Tying Forceps

Overall length 100 mm with extra fine 6 mm long platform
for 7-0 to 9-0 sutures

PAB-404.10 Straight

PAB-404.11 Curved

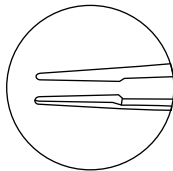

Bonn Tying Forceps (long model)

Overall length 95mm with ultra fine 5 mm long platform
for 9-0 to 11-0 sutures

PAB-405.95

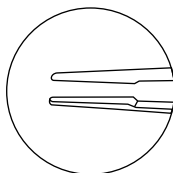

Bonn Tying Forceps (short model)

Overall length 73 mm with ultra fine 5 mm long platform for
9-0 to 11-0 sutures

PAB-406.73

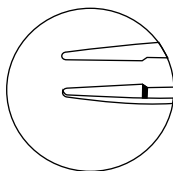

Micro Tying Forceps

Overall length 85 mm with extra fine 6 mm long platform
for 8-0 to 11-0 sutures

PAB-407.85

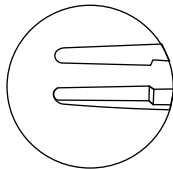

Paufigue Tying Forceps

Overall length 85 mm with standard 7 mm long platform sutures below 7-0

PAB-408.85

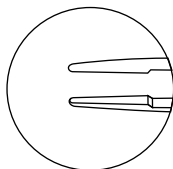

Paufigue Tying Forceps

Overall length 85 mm with delicate 5 mm long platform for 7-0 to 9-0 sutures

PAB-410.85

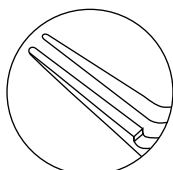

Bechert-McPherson Tying and IOL Forceps

Overall length 105 mm with angled 10 mm long platform for 8-0 to 11-0 sutures

PAB-411.10

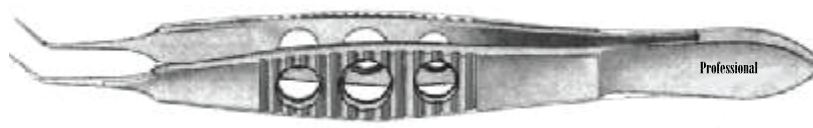
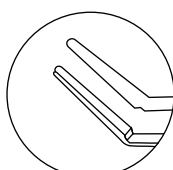

McPherson Tying Forceps angled

Overall length 105 mm with 5 mm long platform for 7-0 to 9-0 sutures

PAB-412.10

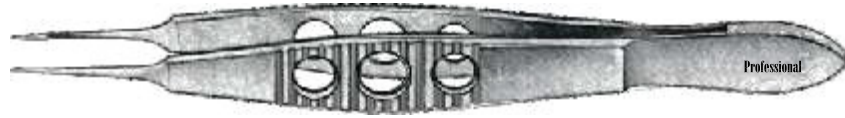
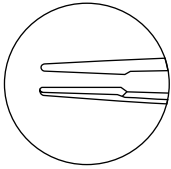

McPherson Tying Forceps Straight

Overall length 105 mm with 5 mm long platform for 8-0 to 11-0 sutures

PAB-413.10

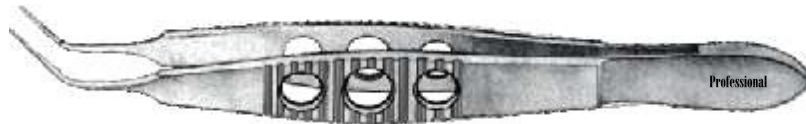
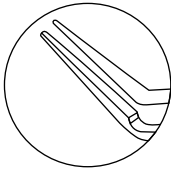

Kelman-McPherson Tying Forceps

Overall length 105 mm with angled 7,5 mm long platform for 8-0 to 11-0 sutures

PAB-414.10

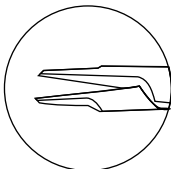

Anis Tying Forceps

Overall length 100 mm with extra delicate 7 mm long platform for 9-0 to 11-0 sutures

PAB-416.10 Straight

PAB-416.11 Curved

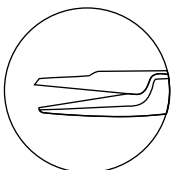

Sinsky Tying Forceps

Overall length 100 mm with very delicate 7 mm long platform for 9-0 to 11-0 sutures

PAB-418.10 Straight

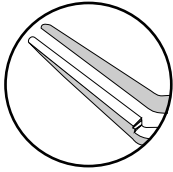

Gaskin Fragment Forceps angled

Overall length 110mm with guide pin and extra fine
11 mm long angled platform
PAB-420.11

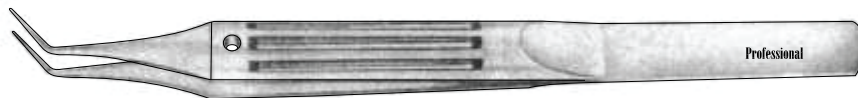
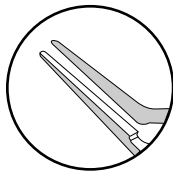

Kelman-McPherson Tying Forceps angled

Overall length 110mm with guide pin and extra fine
8 mm long platform for 9-0 to 11-0 sutures
PAB-421.11

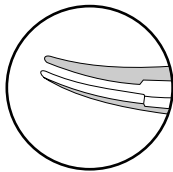

Tennant curved Tying Forceps

Overall length 110mm with guide pin and extra fine
6 mm long platform for 9-0 to 11-0 sutures
PAB-422.11

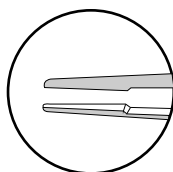

Tennant straight Tying Forceps

Overall length 110mm with guide pin and extra fine
6 mm long platform for 9-0 to 11-0 sutures
PAB-423.10

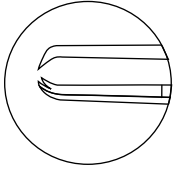

Castroviejo Suturing Forceps

Overall length 105 mm with tying platform and 1x2 teeth

PAB-424.12 0,12 mm

PAB-424.30 0,30 mm

PAB-424.50 0,50 mm

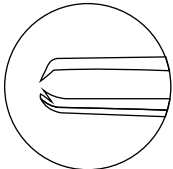

Castroviejo Suturing Forceps (standard handle)

Overall length 100 mm with tying platform and 1x2 teeth

PAB-425.12 0,12 mm

PAB-425.30 0,30 mm

PAB-425.50 0,50 mm

PAB-425.90 0,90 mm

PAB-425.95 1,50 mm

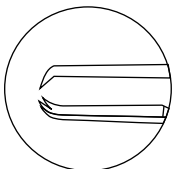

Castroviejo Suturing Forceps (wide handle)

Overall length 100 mm with tying platform and 1x2 teeth

PAB-426.12 0,12 mm

PAB-426.30 0,30 mm

PAB-426.50 0,50 mm

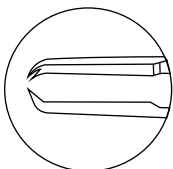

Sinder-Castroviejo Suturing Forceps

Overall length 110 mm with guide pin, tying platform and 1x2 teeth 0,12 mm

PAB-427.11

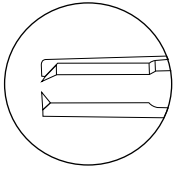

Jaffe Suturing Forceps

Overall length 110 mm 1x2 teeth 0,12 mm set at 90 dg and very delicate platform

PAB-428.11

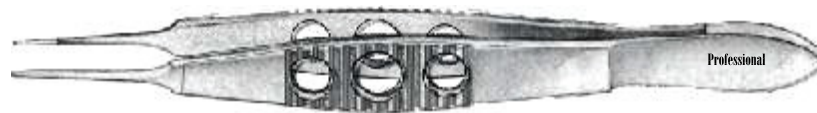
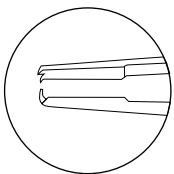

McPherson Suturing Forceps

Overall length 105 mm with 1x2 teeth and straight 5 mm long platform

PAB-429.10

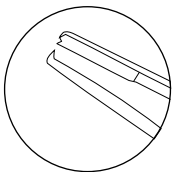

McPherson Suturing Forceps

Overall length 105 mm with 1x2 teeth and straight 5 mm long platform

PAB-430.10

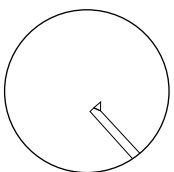

Kelman-McPherson Suturing Forceps

Overall length 105 mm with 8 mm long angled platform and 1x2 teeth 0,12 mm set at 90 dg

PAB-431.10

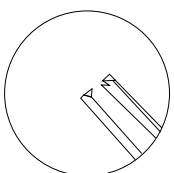

Hoffer-McPherson Suturing Forceps

Overall length 105 mm with 11 mm long angled platform and 1x2 teeth, 0,12 mm set at 90 dg

PAB-432.10

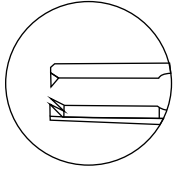

Troutman Suturing Forceps

Overall length 100 mm with extra fine tying platform and 1x2 teeth, 0,12 mm set at 90 dg
PAB-434.10

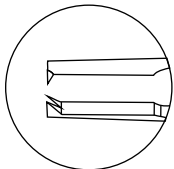

Troutman Suturing Forceps

Overall length 100 mm with extra delicate tying platform and 1x2 teeth 0,12 mm set at 90 dg
PAB-435.10

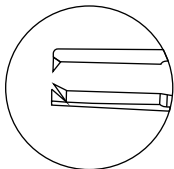

Bonn Suturing Forceps (long model)

Overall length 95 mm with ultra fine tying platform and 1x2 teeth 0,12 mm set at 90 dg
PAB-436.95

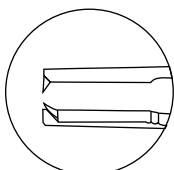

Bonn Suturing Forceps (short model)

Overall length 73 mm with ultra fine tying platform and 1x2 teeth 0,12 mm set at 90 dg
PAB-437.73

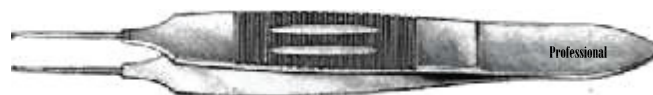
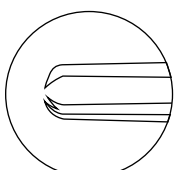

Micro Tying Forceps

Overall length 85 mm with extra fine platform and 1x2 teeth 0,12 mm set at 45 dg
PAB-438.12 12 mm long platform
PAB-438.13 3 mm long platform

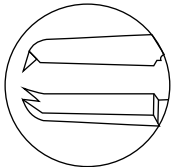

Paufique Universal Suturing Forceps

Overall length 88 mm 1x2 teeth of 0,70 mm set at 45 dg and tying platform

PAB-439.12

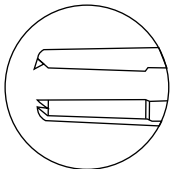

Paufique Universal Suturing Forceps delicate

Overall length 85 mm 1x2 teeth of 0,30 mm set at 45 dg and tying platform

PAB-440.85

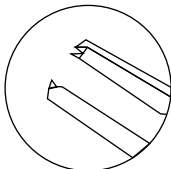

Castroviejo Suturing Forceps (standard handle)

Overall length 105 mm 1x2 teeth and angled tying platform

PAB-441.30 0,30 mm

PAB-441.50 0,50 mm

PAB-441.55 1,50 mm

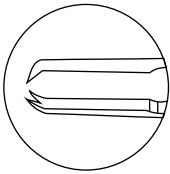

Castroviejo Suture Forceps

Overall length 110 mm with guide pin, tying platform and 1x2 teeth 0,12 mm set at 45 dg

PAB-442.11

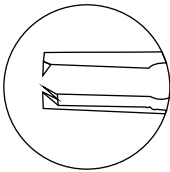

Bonn Suture Forceps

Overall length 110 mm with guide pin, tying platform and 1x2 teeth 0,12 mm set at 90 dg

PAB-443.11

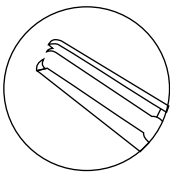

Kelman Suture Forceps angled

Overall length 110 mm with 8mm long tying platform, guide pin and 1x2 teeth, 0,12 mm set at 90 dg

PAB-445.11

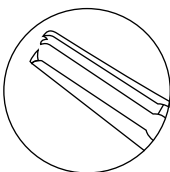

Hoffer Suture Forceps angled

Overall length 110 mm with 11 mm long tying platform, guide pin and 1x2 teeth, 0,12 mm set at 90 dg

PAB-446.11

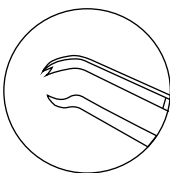

Troutman Suture Forceps

Overall length 110 mm with guide pin, tying platform and 1x2 teeth 0,12 mm set at 45 dg

PAB-447.11

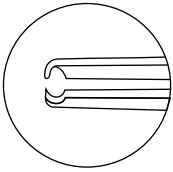

Pierse Corneal Forceps

Overall length 110 mm 1x1 pierse teeth 0,1 mm

PAB-448.01 Straight

PAB-448.02 Curved

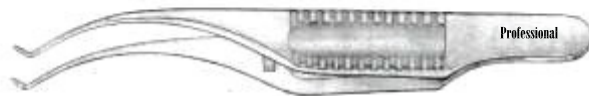
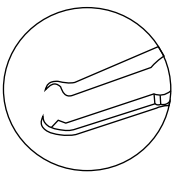

Pierse Corneal Fixation Forceps

Overall length 75 mm 1x1 pierse teeth and tying platform

PAB-448.10 0,10 mm teeth

PAB-448.20 0,20 mm teeth

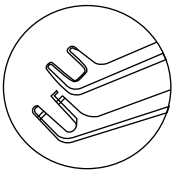

Pierse - Polack Corneal Fixation Forceps

Overall length 75 mm with 1x1 pierse teeth 0,20 mm at each tip, 1 mm spread

PAB-449.75

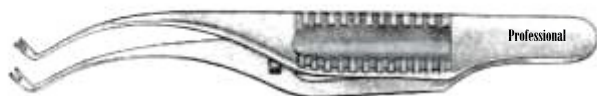

Polack Corneal Fixation Forceps

Overall length 75 mm, two 2,75 mm long tips separated 1 mm with 1x2 teeth 0, 12 mm

PAB-450.75

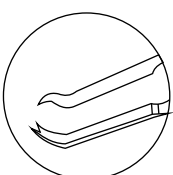

Standard Corneal Suturing Forceps

Overall length 72 mm with 1x2 teeth of 0,45 mm and tying platform

PAB-451.72

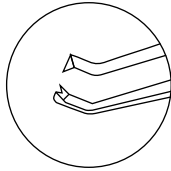

Barraquer Corneal Utility Forceps

Overall length 75 mm 1x2 teeth without tying platform

PAB-452.12 0,12 mm

PAB-452.30 0,30 mm

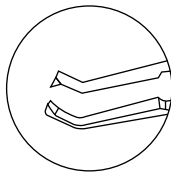

Barraquer Corneal Suturing Forceps

Overall length 75 mm 1x2 teeth with tying platform

PAB-453.12 0,12 mm

PAB-453.30 0,30 mm

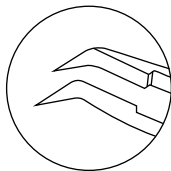

Barraquer Suture Removing Forceps

Overall length 75 mm 1x1 teeth with tying platform

PAB-454.75

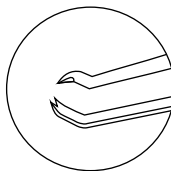

Troutman Corneal Fixation Forceps

Overall length 75 mm 1x2 teeth without tying platform

PAB-455.12 0,12 mm

PAB-455.30 0,30 mm

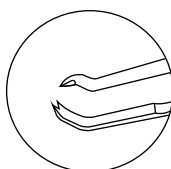

Troutman Corneal Suturing Forceps

Overall length 75 mm 1x2 teeth with tying platform

PAB-456.12 0,12 mm

PAB-456.30 0,30 mm

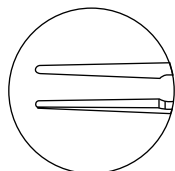

Straight Corneal Tying Forceps

Overall length 85 mm with extra fine 5 mm long jaws and tying platform

PAB-457.85

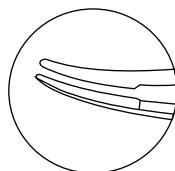

Curved Corneal Tying Forceps

Overall length 82 mm with extra fine 5 mm long jaws and tying platform

PAB-458.82

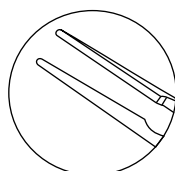

Angled Corneal Tying Forceps

Overall length 82 mm with extra fine 7 mm long angled jaws and tying platform

PAB-459.82

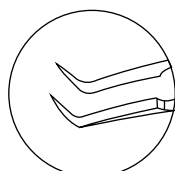

Colibri Corneal Forceps

Overall length 83 mm with extra fine 5 mm long jaws and tying platform

PAB-460.11 Smooth tips, for tying

PAB-460.13 Pointed tips, for suture removal

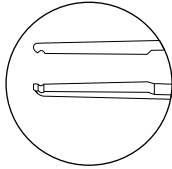

Straight Corneal Fixation Forceps

Overall length 85 mm 1x1 pierse teeth with tying platform
PAB-461.85 0,10 mm teeth

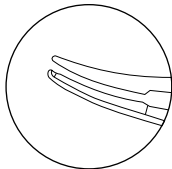

Curved Corneal Fixation Forceps

Overall length 82 mm 1x1 pierse teeth with tying platform
PAB-462.82 0,10 mm teeth



Angled Corneal Fixation Forceps

Overall length 82 mm 1x1 pierse teeth with tying platform
PAB-463.82 0,10 mm teeth

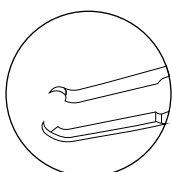

Colibri Corneal Fixation Forceps

Overall length 83 mm 1x1 pierse teeth with tying platform
PAB-464.83 0,10 mm teeth

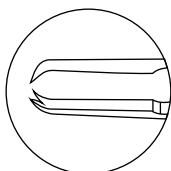

Straight Corneal Suturing Forceps

Overall length 85 mm with 1x2 teeth set at 45 dg and tying platform

PAB-465.85 0,12 mm teeth

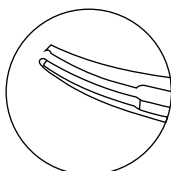

Curved Corneal Suturing Forceps

Overall length 82 mm with 1x2 teeth set at 45 dg and tying platform

PAB-466.82 0,12 mm teeth

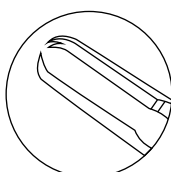

Angled Corneal Suturing Forceps

Overall length 82 mm with 1x2 teeth set at 45 dg and tying platform

PAB-467.82 0,12 mm teeth

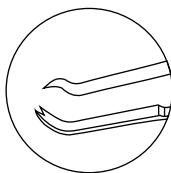

Colibri Corneal Suturing Forceps

Overall length 82 mm with 1x2 teeth set at 45 dg and tying platform

PAB-468.82 0,12 mm teeth

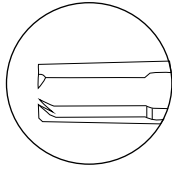

Straight Corneal Utility Forceps

Overall length 85 mm 1x2 teeth set at 90 dg with tying platform

PAB-469.85 0,12 mm teeth

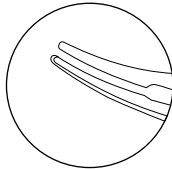

Curved Corneal Utility Forceps

Overall length 82 mm 1x2 teeth set at 90 dg with tying platform

PAB-470.82 0,12 mm teeth

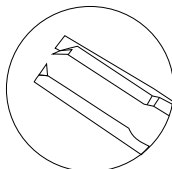

Angled Corneal Utility Forceps

Overall length 82 mm 1x2 teeth set at 90 dg with tying platform

PAB-471.82 0,12 mm teeth

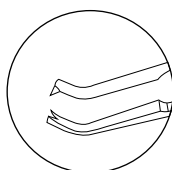

Colibri Corneal Utility Forceps

Overall length 83 mm 1x2 teeth set at 90 dg with tying platform

PAB-472.83 0,12 mm teeth

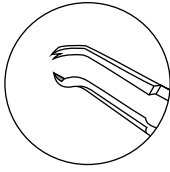

Girard Corneoscleral Forceps

Overall length 100 mm 1x2 teeth 0,12 mm with tying platform

PAB-473.01R Right handed

PAB-473.02L Left handed

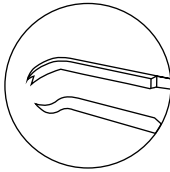

Colibri Corneoscleral Forceps

Overall length 100 mm with tying platform

PAB-474.10 1x2 teeth of 0,12 mm set at 45 dg

PAB-474.12 1x1 pierse teeth of 0,10 mm



Pierse Corneoscleral Forceps

Overall length 100 mm with tying platform and 1x1 pierse teeth 0,10 mm

PAB-475.01 Straight

PAB-475.02 Curved

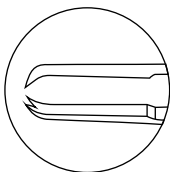

Suturing Corneoscleral Forceps

Overall length 100 mm with 1x2 teeth of 0,12 mm and tying platform

PAB-476.01 Straight

PAB-476.02 Curved

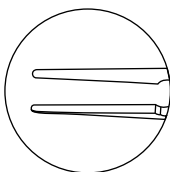

Tying Corneoscleral Forceps

Overall length 100 mm with extra fine 5 mm long tying platform for 8-0 to 11-0 sutures

PAB-477.01 Straight

PAB-477.02 Curved

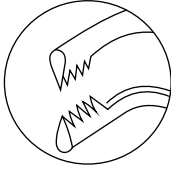

Kuhnt Capsule Forceps
Overall length 100 mm 5x5 teeth
PAB-478.10

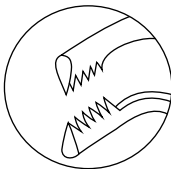

Swiss Model Capsule Forceps
Overall length 95 mm 6x6 teeth
PAB-479.95

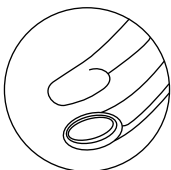

Castroviejo Capsule Forceps
Overall length 100 mm, cross action
PAB-480.10

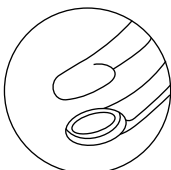

Arruga Capsule Forceps (new model)
Overall length 100 mm
PAB-481.10

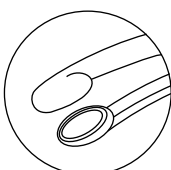

Arruga Capsule Forceps
Overall length 100 mm
PAB-482.10

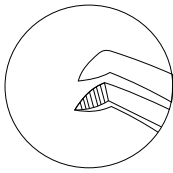

Capsulorhexis Forceps

Overall length 100 mm extremely delicate 12 mm long vaulted shanks with ultra fine serrated tips

PAB-483.10

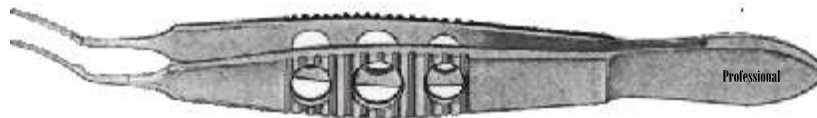
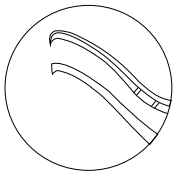

Lehner Capsulorhexis Forceps

Overall length 105 mm with delicate 11 mm long vaulted shanks and ultra fine tips

PAB-484.10

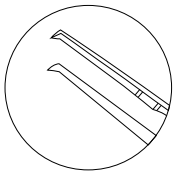

Utrata Capsulorhexis Forceps

Overall length 105 mm extra fine 11 mm long angled shanks with ultra fine tips

PAB-485.10

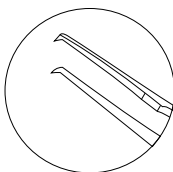

Nevyas Capsulorhexis Forceps

Overall length 105 mm with extremely thin 11 mm long cystotome shaped tips for penetrating and grasping anterior capsule

PAB-486.10

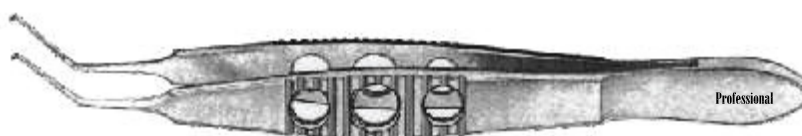
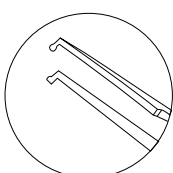

Jaffe Capsulorhexis Forceps

Overall length 105 mm with extremely thin 11 mm long shanks and extra delicate round grasping tips

PAB-487.10

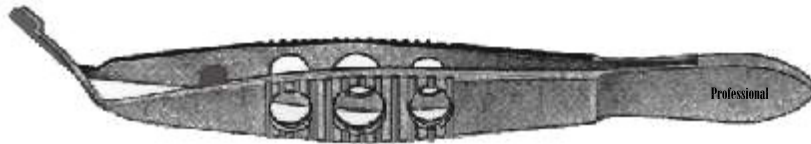
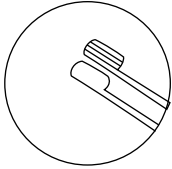

Ernest - Calf Nucleus Cracking Forceps

Overall length 105 mm extremely thin paddle shaped jaws with longitudinally serrated surfaces (cross action)
PAB-488.10

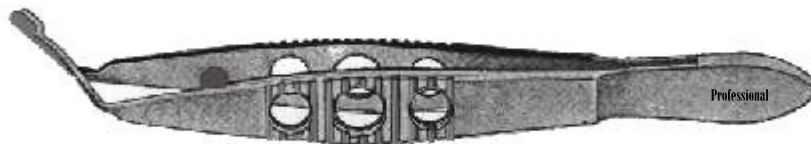
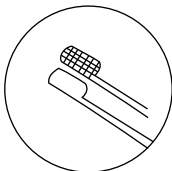

Kraff Nucleus Fracture Forceps

Overall length 105 mm extremely thin paddle shaped jaws with cross serrated surfaces (cross action)
PAB-489.10

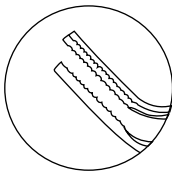

Kansas Nucleus Removal Forceps

Overall length 105 mm with angled 10 mm long delicate jaws with multiple parallel teeth
PAB-490.10

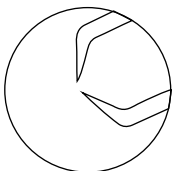

Dardenne Nucleus Fragment Forceps

Overall length 105 mm with angled 10 mm long shanks and 1 mm long grasping tips
PAB-491.10

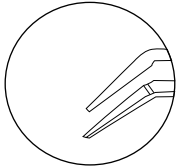

Kelman-McPherson Fragment Forceps

Overall length 100 mm with delicate angled 7.5 mm long shanks

PAB-492.10

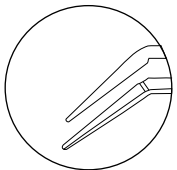

Gaskin Fragment Forceps

Overall length 105 mm with delicate 45 dg angled shanks and smooth platform

PAB-493.09 9 mm angled

PAB-493.11 11 mm angled

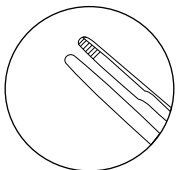

Osher Foreign Body Removal Forceps

Overall length 105 mm extra fine 11 mm long 60 dg angled shanks with 3 mm long platform

PAB-494.10

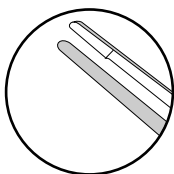

Kraff Capsule Tag Forceps

Overall length 105 mm with thin 11 mm , long shanks and 1,5 mm long platform

PAB-495.10

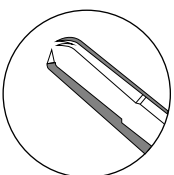

Witschel Capsule Flap Forceps

Overall length 105 mm with 45 dg angled 11 mm long shanks and 5 mm long platform with 1x2 teeth of 0,10 mm

PAB-496.10



Desmarres Chalazion Forceps

Oval blades

PAB-497.20 20 mm

PAB-497.26 26 mm

PAB-497.30 30 mm



Francis Chalazion Forceps

Overall length 95 mm oval blades 12x14 mm

PAB-498.95

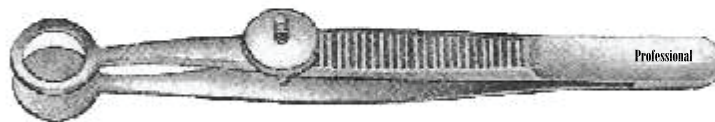

Lambert Chalazion Forceps

Overall length 90 mm round blade 8 mm dia

PAB-499.90

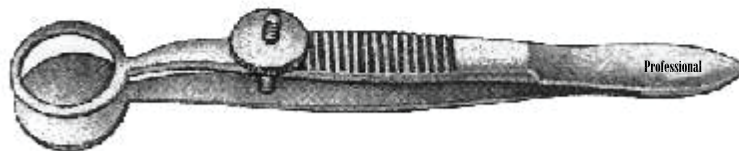

Hunt Chalazion Forceps

Overall length 95 mm round blade 12 mm dia

PAB-500.95



Cauer Chalazion Forceps

Overall length 100 mm round blade 12 mm serrated

PAB-501.10



Lordan Chalazion Forceps
Overall length 95 mm
PAB-502.95



Wies Chalazion Forceps
Overall length 95 mm grooved upper jaw
PAB-503.95

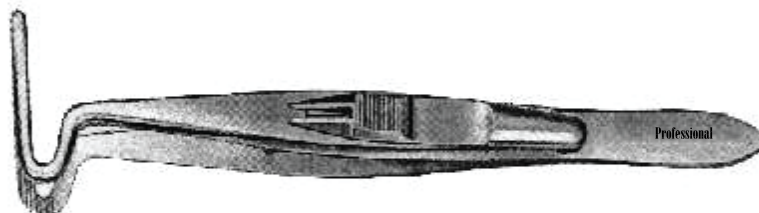

Berke Ptosis Forceps
Overall length 105 mm with longitudinally grooves and slide lock
PAB-504.20 20 mm
PAB-504.27 27 mm

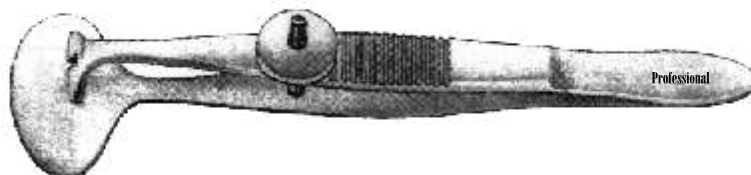

Erhardt Lid Forceps
Overall length 95 mm oval lower blade and serrated upper blade
PAB-505.95



Snellen Entropium Forceps
Overall length 95 mm
PAB-506.01 Right
PAB-506.02 Left



Cueppers Strabismus Muscle Tucker
PAB-507-01



Sattler Muscle Forceps
Overall length 100 mm, angled with 3 holes and teeth
and side lock
PAB-508.22 Right
PAB-508.23 Left



Jameson Muscle Forceps (child size)
Overall length 100 mm, angled with 4 holes and teeth
and slide lock
PAB-509.01 Right
PAB-509.02 Left

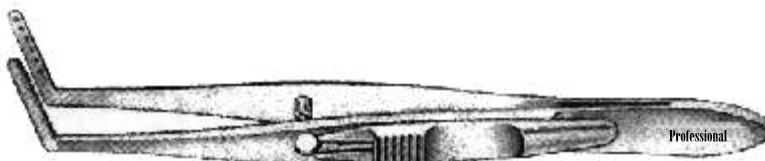

Jameson Muscle Forceps (adult size)
Overall length 100 mm, angled with 6 holes and teeth
and slide lock
PAB-510.01 Right
PAB-510.02 Left



Bangerter Muscle Forceps
Overall length 105 mm
PAB-511.10

Professional

- Eye surgery • Augen-Instrumentarium • Oftalmologia
- Chirurgie ophtalmologique • Oftalmologia



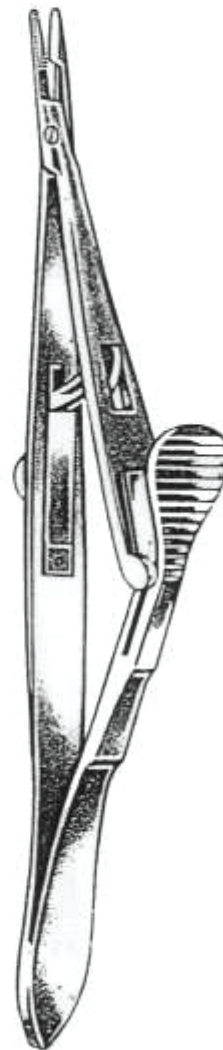
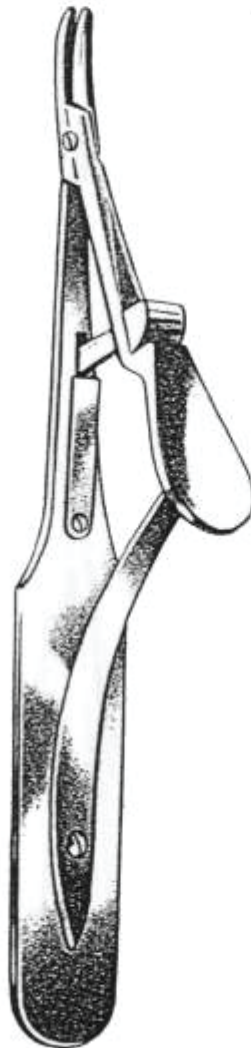
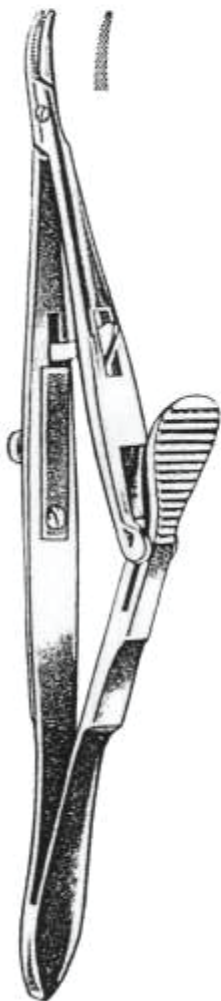

KALT

PAB-550.13 13cm
gerade
straight
recta
droit

PAB-551.13 13cm
gebogen
curved
curva
courbee

ARRUGA

PAB-552.14 14cm
gerade
straight
recta
droit

PAB-553.14 14cm
gebogen
curved
curva
courbee

CASTROVIEJO KALT
PAB-555.16 16CM

STEVENS
PAB-554.14 14cm

• Eye surgery • Augen-Instrumentarium • Oftalmologia



Ohne Schloss
without catch
sin muelle sana
ressort

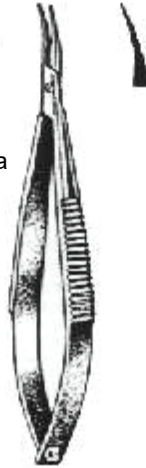

Mit Schloss
with catch
con muelle
avec ressort

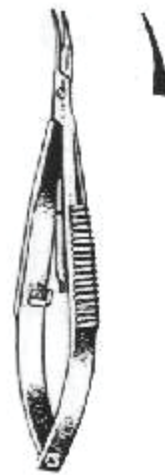

MICRO-CASTROVIEJO
PAB-560.09 9cm
PAB-561.09 9cm

MICRO-CASTROVIEJO
PAB-562.09 9cm
PAB-563.09 9cm



Ohne Schloss
without catch
sin muelle
sans resson



Mit Schloss
with catch
con muelle
avec ressort

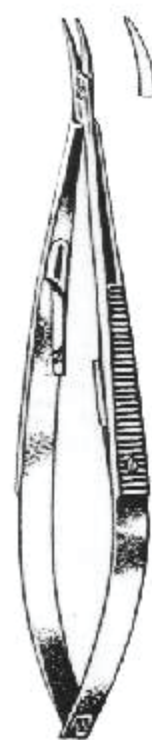

CASTROVIEJO
PAB-564.14
14 cm

CASTROVIEJO
PAB-565.14
14 cm

CASTROVIEJO
PAB-566.14
14 cm

CASTROVIEJO
PAB-567.14
14 cm

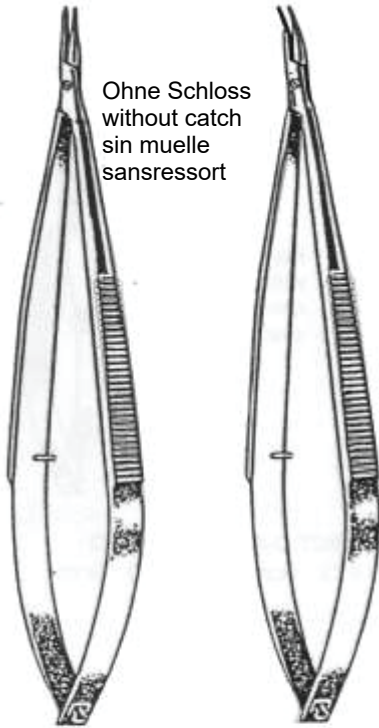

Ohne Schloss
without catch
sin muelle
sansressort

MICRO - CASTROVIEJO
PAB-570.14 **PAB-571.14**
14cm 14cm

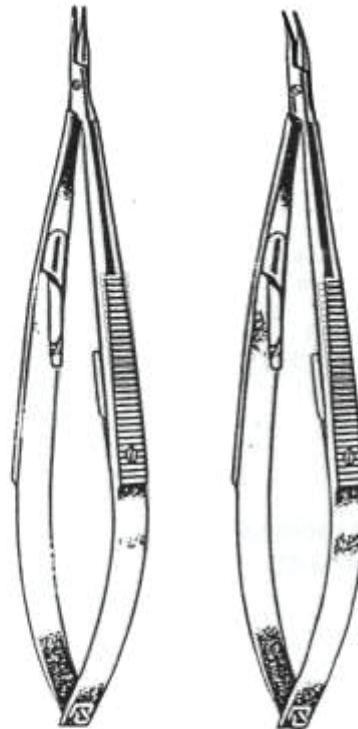

MICRO - CASTROVIEJO
PAB-572.14 **PAB-573.14**
14cm 14cm



CASTROVIEJO
PAB-574.14
14cm



Ohne Schloss
without catch
sin muelle
sans ressort

PAB-575.10
10 cm



Ohne Schloss
without catch
sin muelle
sana ressort

BARRAQUER
PAB-576.13 **PAB-577.13**
13cm 13cm



Mit Schioss
with catch
con muelle
avec ressort

BARRAQUER
PAB-578.13 **PAB-579.13**
13cm 13cm



Ohne Schloss
without catch
sin muelle
sans ressort

BARRAQUER

PAB-580.10 **PAB-581.10**
9.5 cm 9.5 cm



Mit Schloss
with catch con
muelle avec ressort

BARRAQUER

PAB-582.10 **PAB-583.10**
9.5 cm 9.5 cm



Mit Schloss
with catch
con muelle
avec ressort

PAB-584.14
13.5 cm

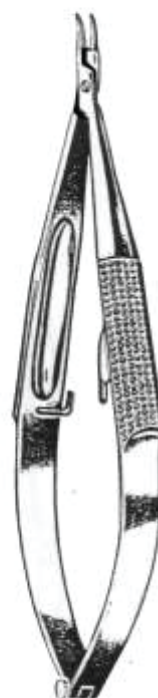

Mit Schloss
with catch
con muelle
avec ressort

BARRAQUER
PAB-585.13
13 cm

0.5mm



0.75mm



Ohne Schloss
without catch
sin muelle
sans ressort

BARRAQUER

PAB-587.12 PAB-588.12

11.5 cm

0.5mm



0.75mm



mit Schloss
with catch
con muelle
avec ressort

BARRAQUER

PAB-589.12 PAB-590.12

11.5 cm

0.75 mm



1.0 mm



Ohne Schloss
without catch
sin muelle
sans ressort

BARRAQUER

PAB-591.14 PAB-592.14

14 cm

0.75 mm



1.0 mm



mit Schloss
with catch
con muelle
avec ressort

BARRAQUER

PAB-593.14 PAB-594.14

14 cm

Professional

- Eye surgery • Augen-Instrumentarium • Oftalmologia
- Chirurgie ophtalmologique • Oftalmologia



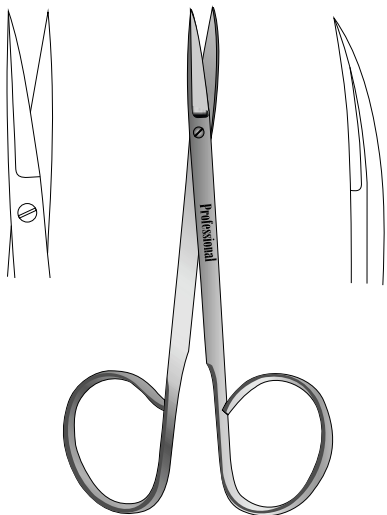

PAB-595.11 10,5 cm
Gerade
straight
recta
droit



PAB-596.11
Gebogen
curved
curva
courbe



PAB-597.10 9,5 cm
Gerade
straight
recta
droit

PAB-598.10
Gebogen
curved
curva
courbe



STEVENS PAB-599.10 10 cm



STEVENS PAB-600.10 10 cm



STEVENS PAB-601.10 10 cm

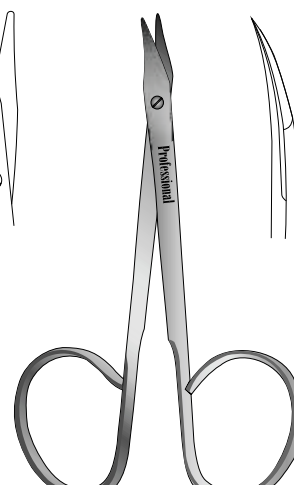

STEVENS PAB-602.10 10 cm

• Eye surgery • Augen-Instrumentarium • Oftalmologia



BONN
PAB-603.09
9 cm

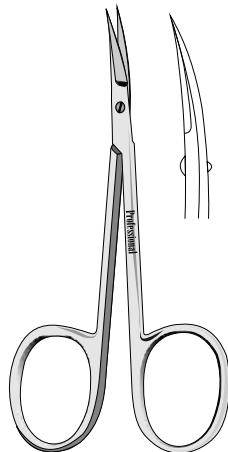

BONN
PAB-604.09
9 cm

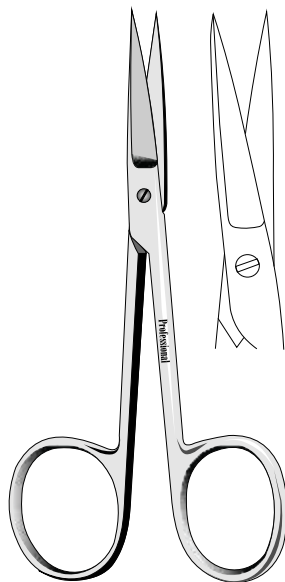

MICROSCOPIC
PAB-605.11
11 cm



MICROSCOPIC
PAB-606.11
11 cm

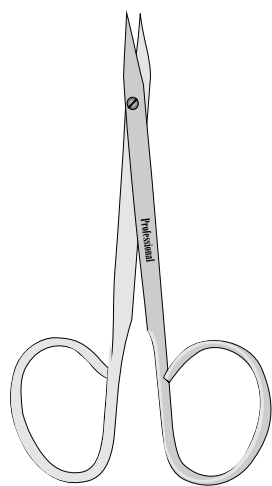

PAB-607.10
9,5 cm

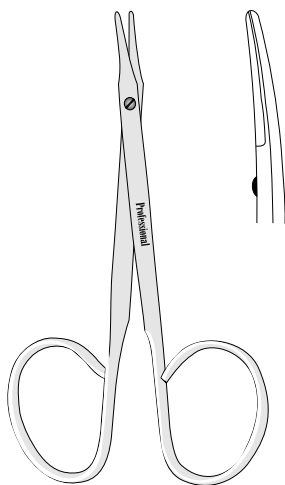

PAB-608.10
9,5 cm

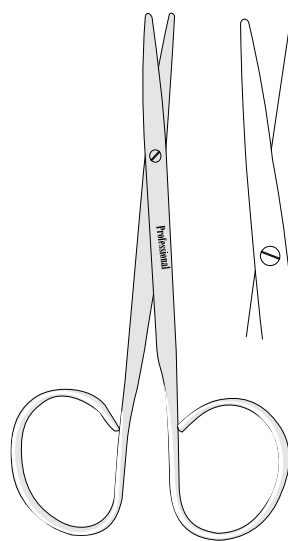

STRABISMUS
PAB-609.10
10 cm

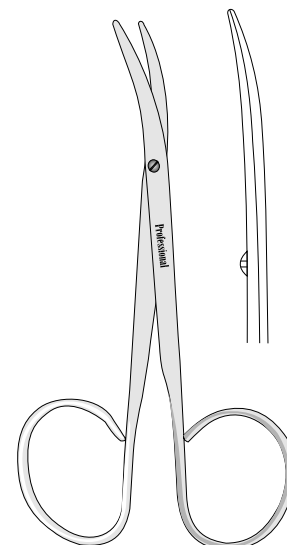

STRABISMUS
PAB-610.10
10 cm

Delicate Scissors

• Chirurgie ophtalmologique • Oftalmologia

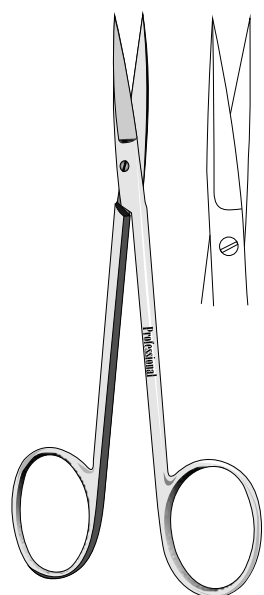

PAB-612.09 9.0 cm
PAB-612.11 10.5cm
PAB-612.12 11.5cm

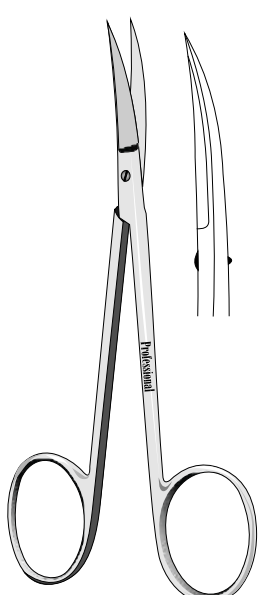

PAB-613.09 9.0 cm
PAB-613.11 10.5cm
PAB-613.12 11.5cm

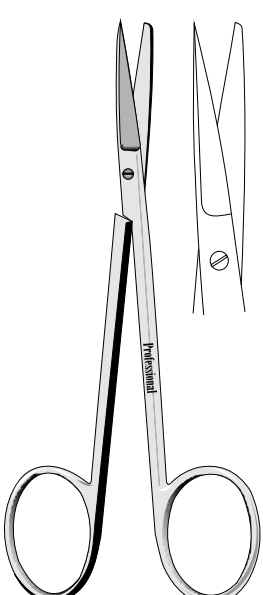

PAB-614.12
 11.5 cm

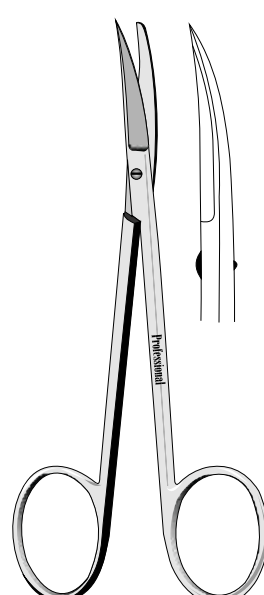

PAB-615.12
 11.5 cm

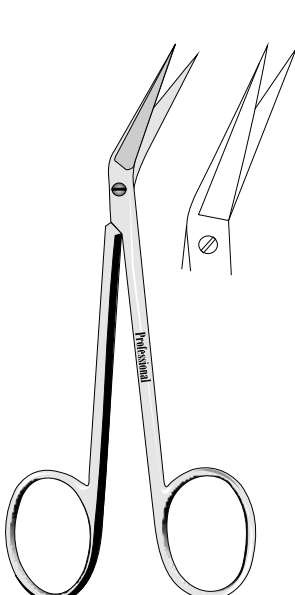

PAB-616.12
 11.5 cm

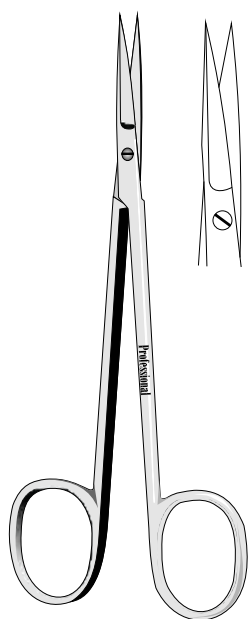

KNAPP
PAB-617.11 10.5cm
PAB-617.12 12.0cm

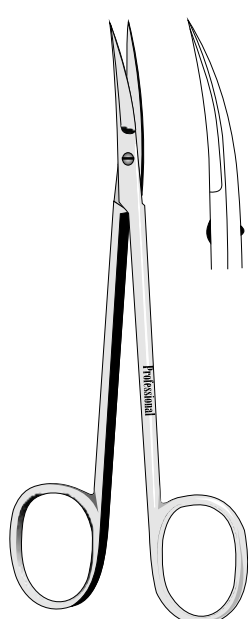

KNAPP
PAB-618.11 10.5cm
PAB-618.12 12.0cm

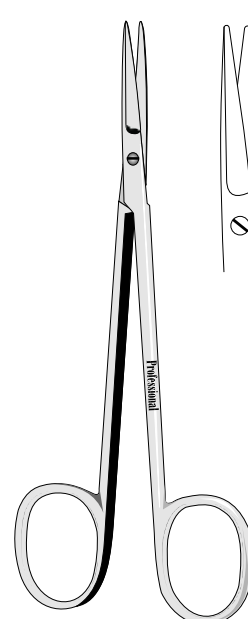

KNAPP
PAB-619.11 10.5cm
PAB-619.12 12.0cm

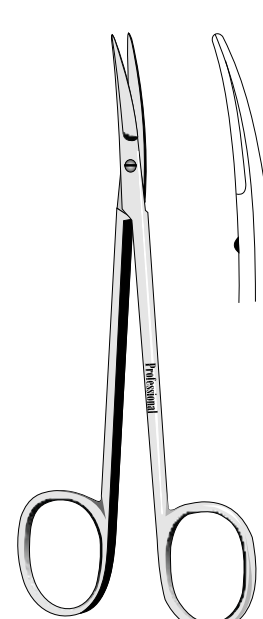

KNAPP
PAB-620.11 10.5cm
PAB-620.12 12.0cm

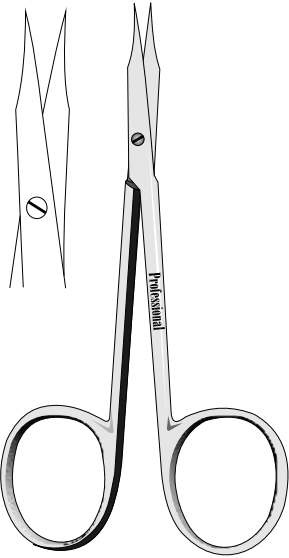

SREVENS
PAB-622.11 10,5 cm
PAB-622.12 11,5 cm



STEVENS
PAB-623.11 10,5 cm
PAB-623.12 11,5 cm



STEVENS
PAB-624.11 10,5 cm
PAB-624.12 11,5 cm

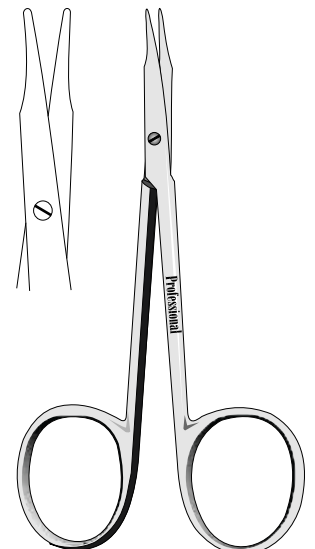

STEVENS
PAB-625.11 10,5 cm
PAB-625.12 11,5 cm



STRABISMUS
PAB-626.11
 11 cm



STRABISMUS
PAB-627.11
 11 cm



LAGRANGE
PAB-628.09
 9 cm

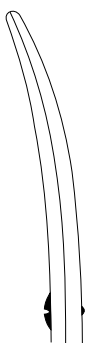
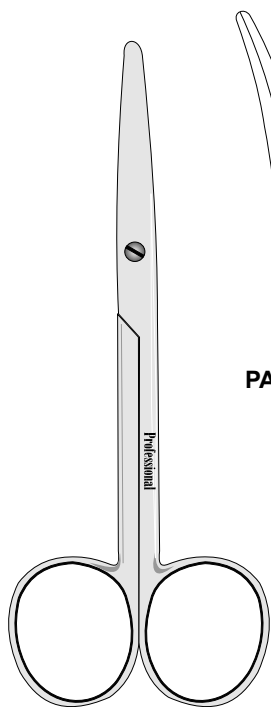

PAB-629.02

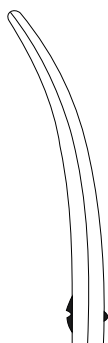

PAB-629.03

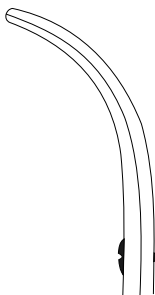

PAB-629.04



PAB-630.12 11,5 cm
Fur Kinder
for children
para ninos
pour enfants

PAB-629.01 12 cm
PAB-629.02 12 cm
PAB-629.03 12 cm
PAB-629.04 12 cm

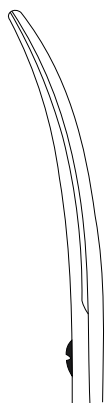
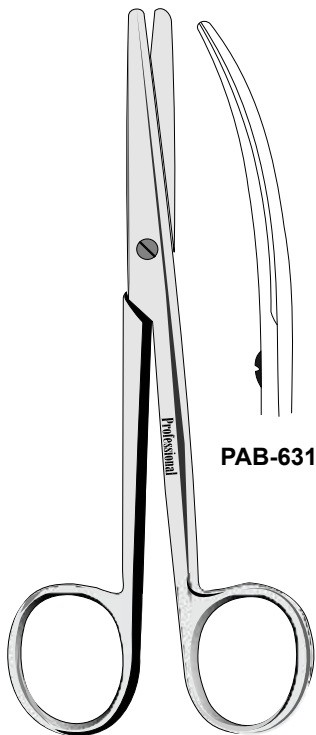

PAB-631.01



PAB-631.02

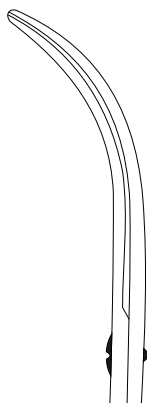

PAB-631.03



PAB-631.01 13,5 cm
PAB-631.02 13,5 cm
PAB-631.03 13,5 cm

WERBS DCR SCISSORS
11 cm, 30 mm blades,
with 5mm angled ends



PAB-635.02



PAB-636.02



PAB-637.02



PAB-638.02



PAB-639.02



PAB-640.02



PAB-635.03



PAB-636.03



PAB-637.03



PAB-638.03



PAB-639.03



PAB-640.03



PAB-635.04



PAB-636.04



PAB-637.04



PAB-638.04



PAB-639.04



PAB-640.04



PAB-635.02 10cm
PAB-635.03 10cm
PAB-635.04 10cm

PAB-636.02 10cm
PAB-636.03 10cm
PAB-636.04 10cm

PAB-637.02 11cm
PAB-637.03 11cm
PAB-637.04 11cm

PAB-638.02 11cm
PAB-638.03 11cm
PAB-638.04 11cm

NOYES
PAB-639.02 11.5cm
PAB-639.03 11.5cm
PAB-639.04 11.5cm

NOYES
PAB-640.02 11.5cm
PAB-640.03 11.5cm
PAB-640.04 11.5cm



TUEBINGEN
PAB-642.85
8.5 cm



TUEBINGEN
PAB-643.85
8.5 cm



PAB-644.80 8.5 cm



PAB-645.80 8.5 cm

Trabekular-Schere
Trabekular scissors
Tijeras trabeculares
Ciseaux a trabeculaires

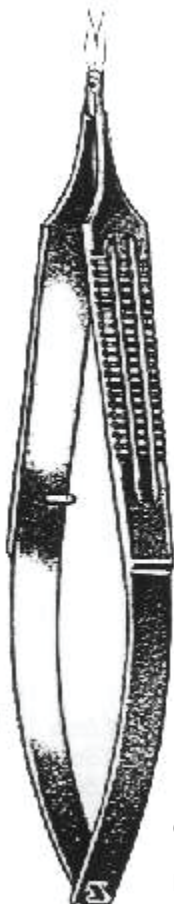

**CASTROVIEJO -
VANNAS**
PAB-646.12
11.5 cm

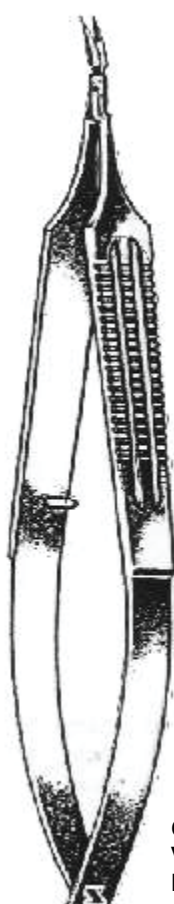

**CASTROVIEJO -
VANNAS**
PAB-647.12
11.5 cm

Sharp pointed tips.
11 mm from mid screw
to tip



McPHERSON-VANNAS
PAB-648.85
8,5 cm

Professional

• Eye surgery • Augen-Instrumentarium • Oftalmologia



VANNAS
PAB-649.80
8 cm



VANNAS
PAB-650.80
8 cm

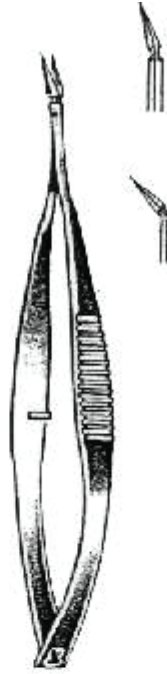

VANNAS
PAB-651.80 8 cm
PAB-652.80 8 cm



VANNAS
PAB-652.80
8 cm

Extra klein - extremely delicate - delicate - extra fine



VANNAS
PAB-653.80
8 cm



VANNAS
PAB-654.80
8 cm

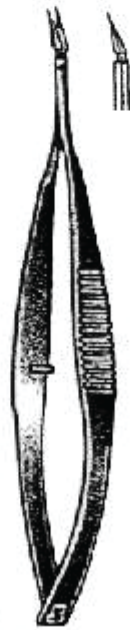

VANNAS
PAB-655.80
8 cm



VANNAS
PAB-656.80
8 cm



PAB-662.01



PAB-662.02



PAB-663.01



PAB-663.02



PAB-662.03



PAB-662.04



PAB-663.03



PAB-663.04



PAB-658.55



PAB-660.55



PAB-659.55



PAB-661.55



BARRAQUER
PAB-658.55 5.5 cm
PAB-659.55 5.5 cm

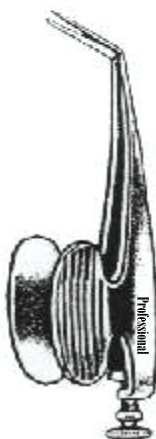

BARRAQUER
PAB-660.55 5.5 cm
PAB-661.55 5.5 cm

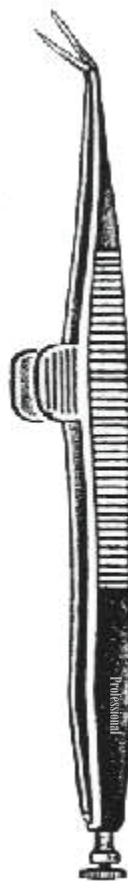

WECKER
PAB-662.01 11.5cm
PAB-662.02 11.5cm
PAB-662.03 11.5cm
PAB-662.04 11.5cm

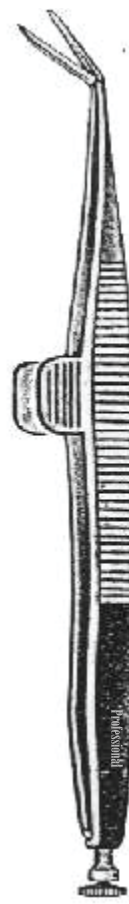

WECKER
PAB-663.01 11.5cm
PAB-663.02 11.5cm
PAB-663.03 11.5cm
PAB-663.04 11.5cm

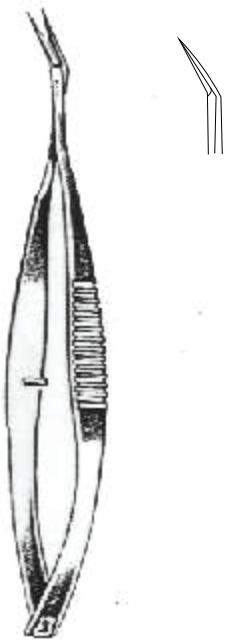

GIL
PAB-664.01

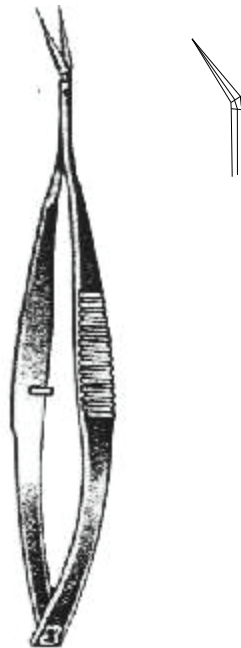

ONG
PAB-665.02

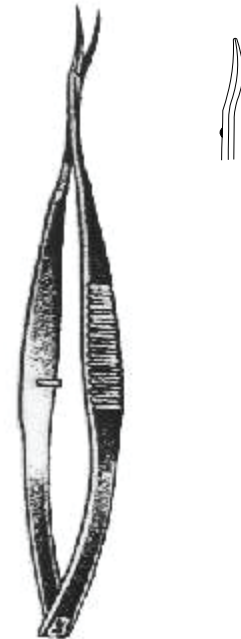

UTHOFF
PAB-666.03

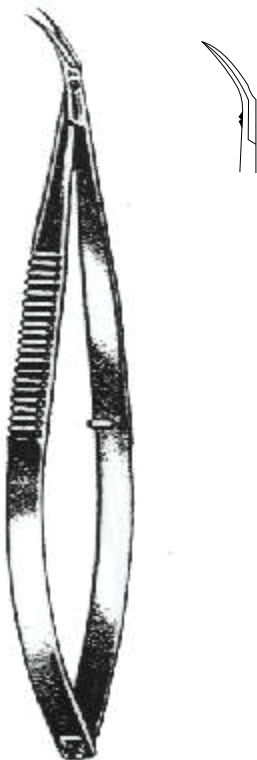

URIBE-STERN
PAB-667.04



HOFFER-STERN
PAB-668.05



PAB-670.10
10cm



PAB-671.10
10cm

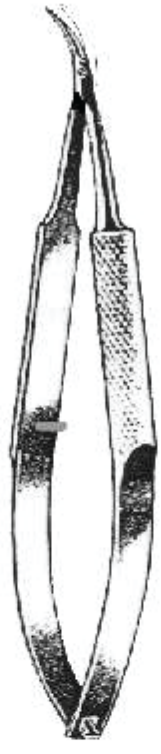

PAB-672.10
10cm

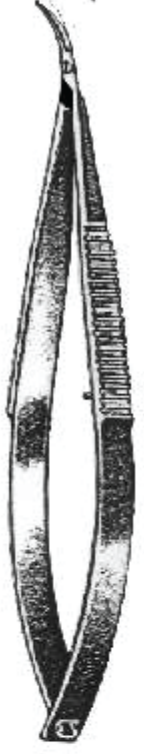

PAB-673.10
10cm



Kniegebogen
angled to side
anguloso
coude

PAB-674.10
10cm



PAB-675.10
10cm



Aufgewinkelt
angled on flat
anguloso
angulaire

PAB-676.10
10cm



PAB-677.10
10cm

• Eye surgery • Augen-Instrumentarium • Oftalmologia

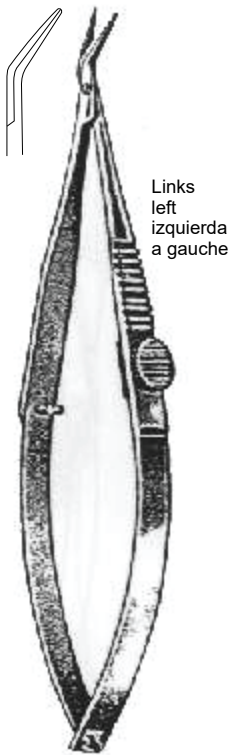

Links
left
izquierda
a gauche

BARRAQUER
PAB-678.01

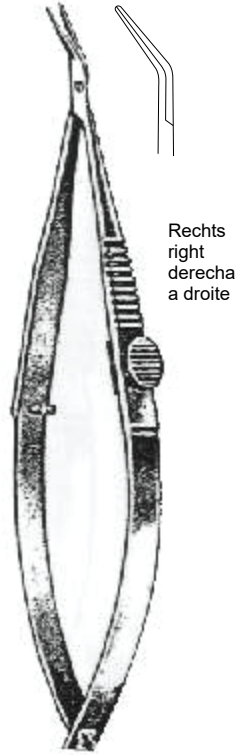

Rechts
right
derecha
a droite

BARRAQUER
PAB-679.01

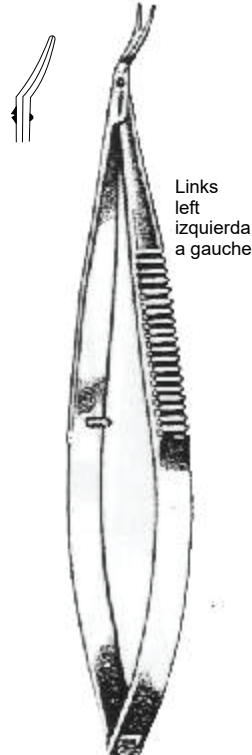

Links
left
izquierda
a gauche

MC QUIRE
PAB-680.01

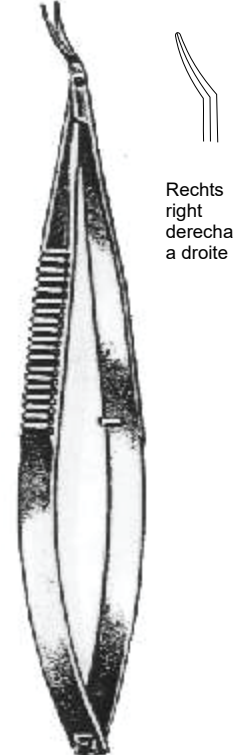

Rechts
right
derecha
a droite

MC QUIRE
PAB-681.01

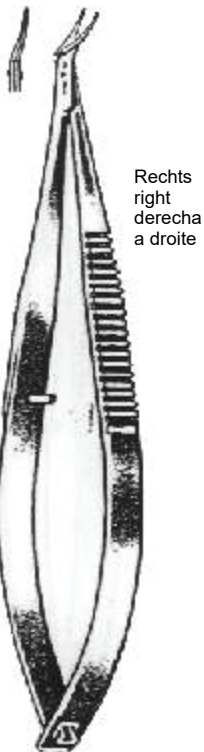

Rechts
right
derecha
a droite

**TROUTMAN-
CASTROVIEJO**
PAB-682.01

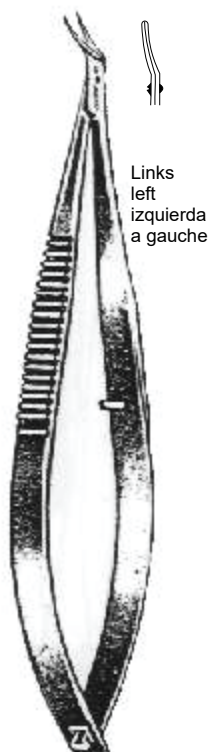

Links
left
izquierda
a gauche

**TROUTMAN-
CASTROVIEJO**
PAB-683.01



Links
left
izquierda
a gauche

TROUTMAN
PAB-684.01

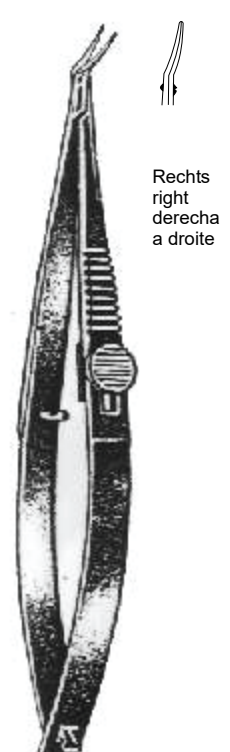

Rechts
right
derecha
a droite

TROUTMAN
PAB-685.01

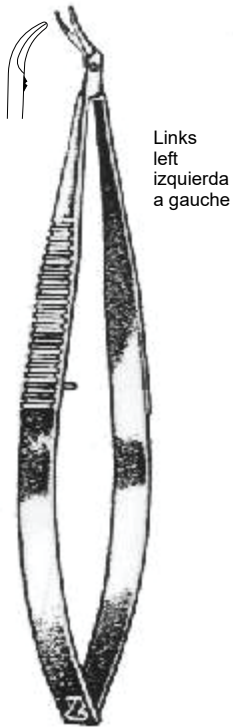

Links
left
izquierda
a gauche

**KATZIN
PAB-686.01**

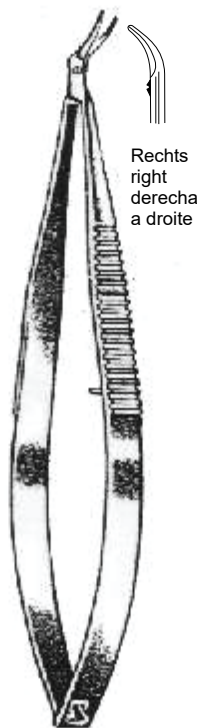

Rechts
right
derecha
a droite

**KATZIN
PAB-687.01**

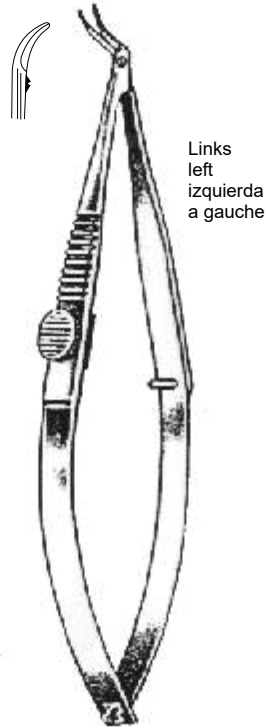

Links
left
izquierda
a gauche

**KATZIN
PAB-688.01**

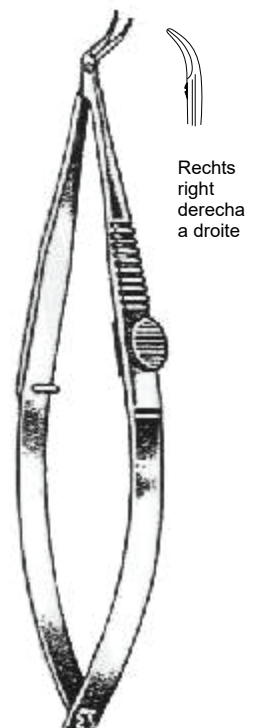

Rechts
right
derecha
a droite

**KATZIN
PAB-688.01**

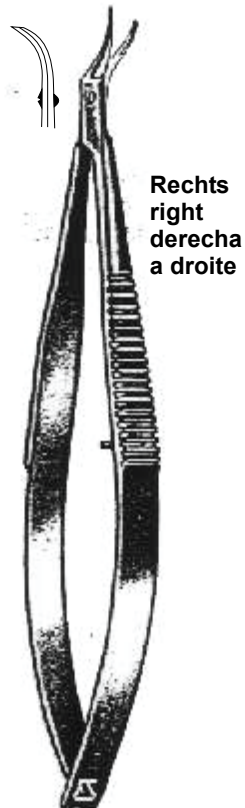

Rechts
right
derecha
a droite

**KATZIN
PAB-689.01**

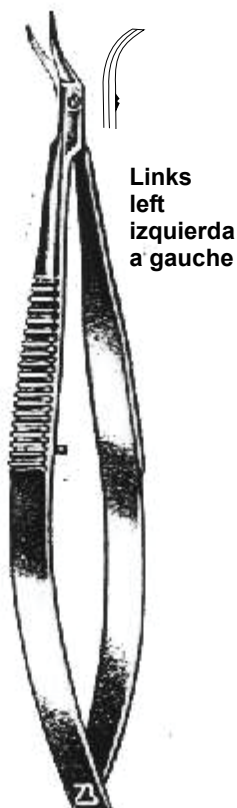

Links
left
izquierda
a gauche

**KATZIN
PAB-690.01**

• Eye surgery • Augen-Instrumentarium • Oftalmologia

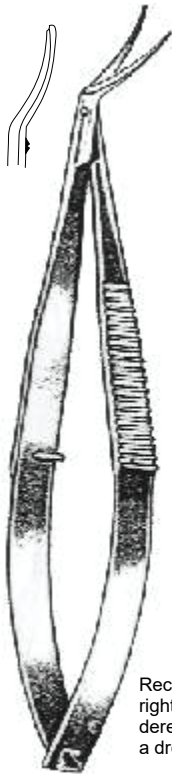

Rechts
right
derecha
a droite

CASTROVIEJO
PAB-691.10
10cm

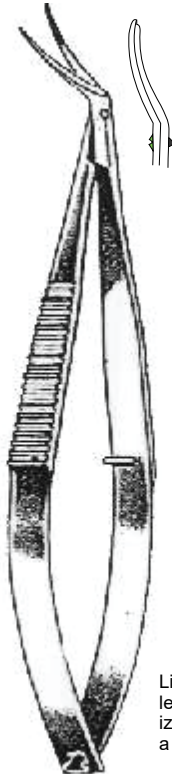

Links
left
izquierda
a gauche

CASTROVIEJO
PAB-692.10
10cm



Rechts
right
derecha
a droite

MINI-CASTROVIEJO
PAB-693.10
10cm



Links
left
izquierda
a gauche

MINI-CASTROVIEJO
PAB-694.10
10cm

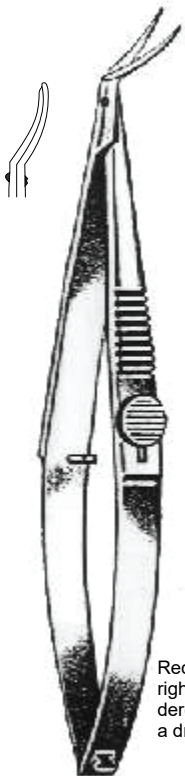

Rechts
right
derecha
a droite

MINI-CASTROVIEJO
PAB-695.10
10cm

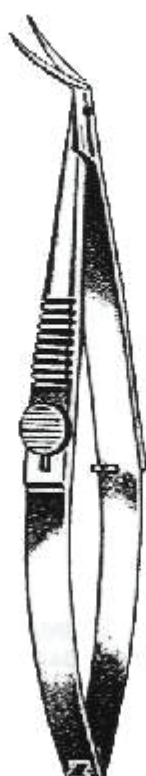

Links
left
izquierda
a gauche

MINI-CASTROVIEJO
PAB-696.10
10cm

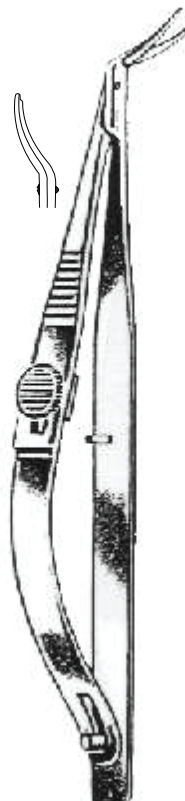

MINI-CASTROVIEJO
PAB-697.11
10.5cm

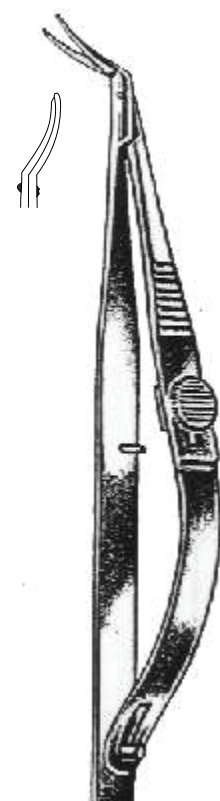

MINI-CASTROVIEJO
PAB-698.11
10.5cm



Rechts
right
derecha
a droite

**MICRO-CASTROVIEJO
PAB-699.10**
10cm

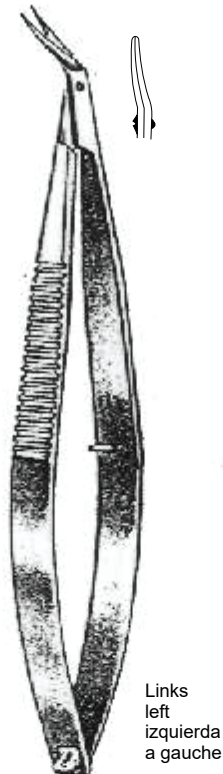

Links
left
izquierda
a gauche

**MICRO-CASTROVIEJO
PAB-700.10**
10cm

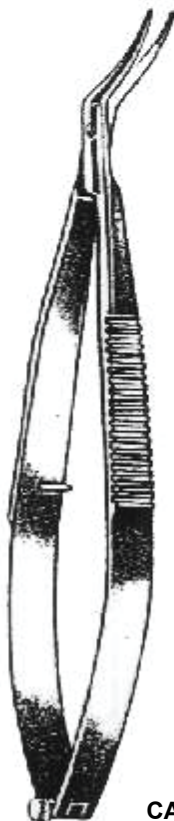

**CASTROVIEJO
PAB-701.11**
10.5cm

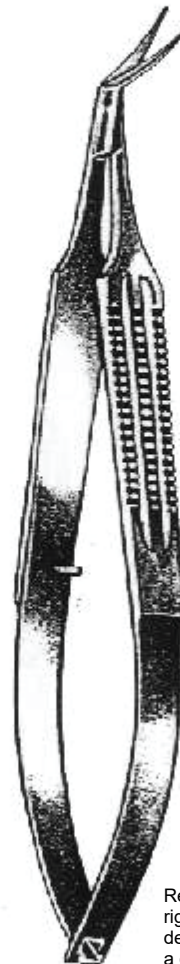

Rechts
right
derecha
a droite

**MINI-CASTROVIEJO
PAB-702.13**
12.5cm

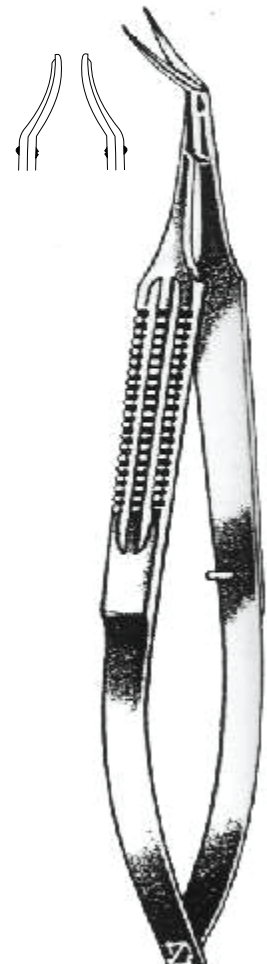

Links
left
izquierda
a gauche

**MINI-CASTROVIEJO
PAB-703.13**
12.5cm

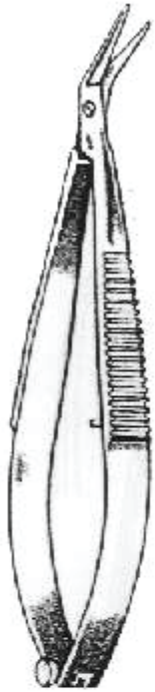

CASTROVIEJO
PAB-704.90
 9 cm



CASTROVIEJO
PAB-705.90
 9 cm



CASTROVIEJO
PAB-706.90 9 cm
PAB-707.90 9 cm



PAB-706.90



PAB-707.90

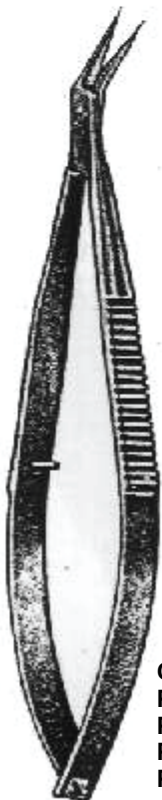

PAB-708.01



PAB-708.02



PAB-708.03



PAB-708.04

CASTROVIEJO
PAB-708.01 10.5cm
PAB-708.02 10.5cm
PAB-708.03 10.5cm
PAB-708.04 10.5cm

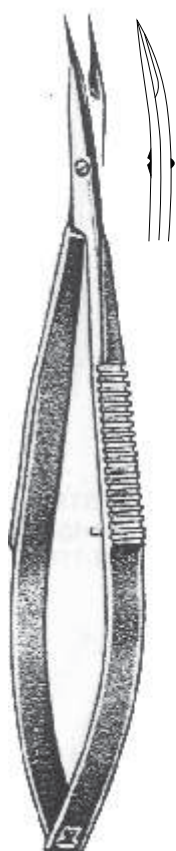

WESTCOTT
PAB-709.11
11cm

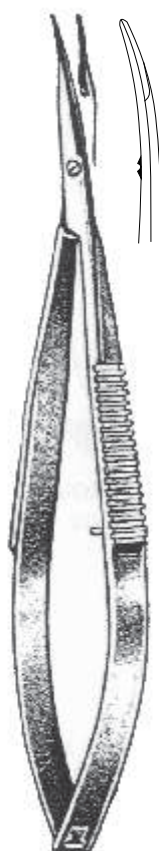

WESTCOTT
PAB-710.11 11cm
PAB-710.13 13cm

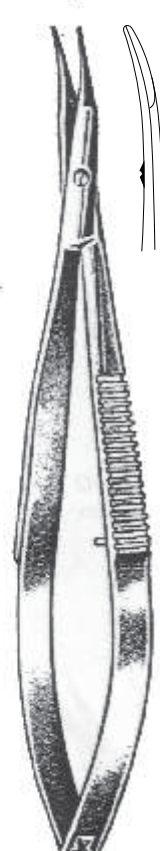

WESTCOTT
PAB-711.11
11cm

Professional

- Eye surgery • Augen-Instrumentarium • Oftalmologia
- Chirurgie ophtalmologique • Oftalmologia

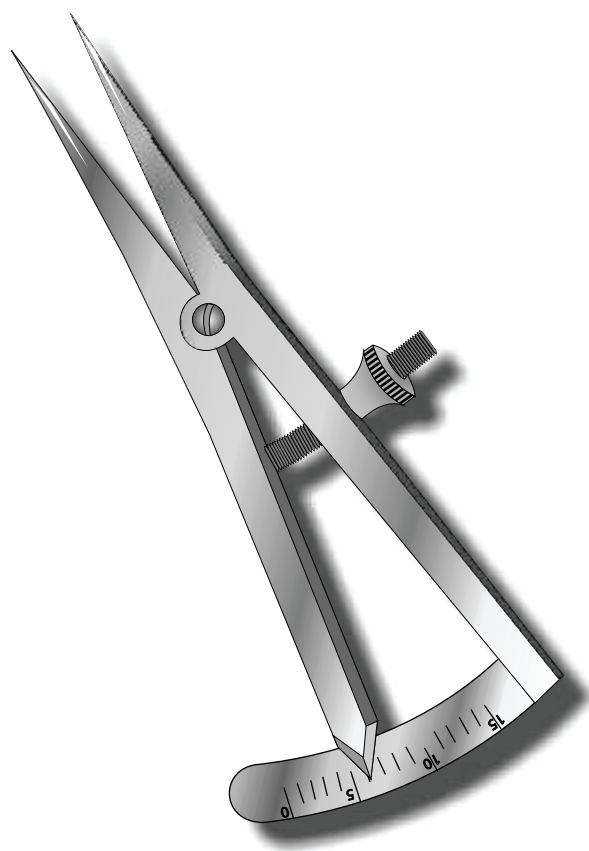

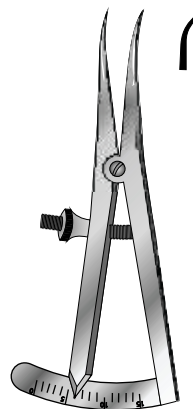
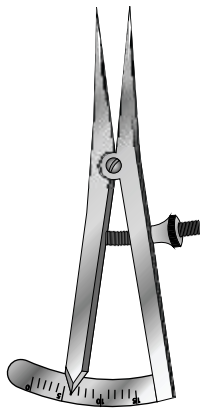

CASTROVIEJO-SCHAECHER
 PAB-721.70 7 cm



PAB-722.11



WILDER
 PAB-723.11
 11 cm, 4 1/2"



PAB-724.11

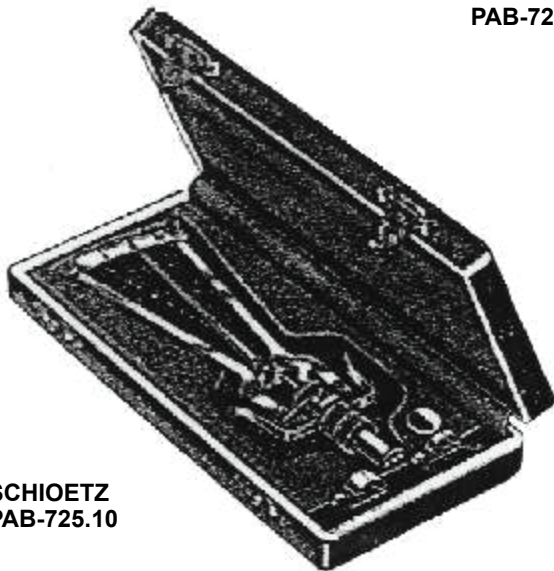

SCHIOETZ
 PAB-725.10

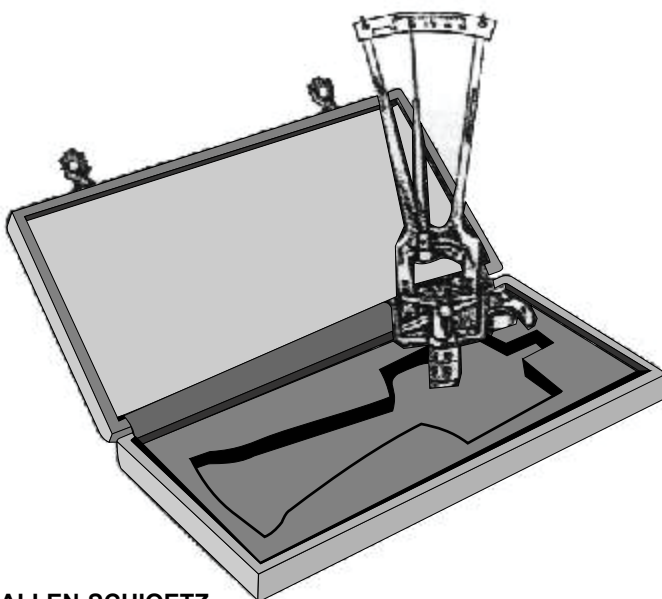

ALLEN-SCHIOETZ
 PAB-726.11



CASTROVIEJO
 PAB-727.12
 12CM, 4 3/4"



ZIEGLER
 PAB-728.12 1 + 2
 PAB-728.34 3 + 4
 PAB-728.56 5 + 6
 14cm



BOWMAN

- PAB-730.04 Fig. 0000/000
- PAB-730.03 Fig. 000/00
- PAB-730.02 Fig. 00/0
- PAB-730.11 Fig. 0/1
- PAB-730.12 Fig. 1/2
- PAB-730.23 Fig. 2/3
- PAB-730.34 Fig. 3/4
- PAB-730.45 Fig. 4/5
- PAB-730.56 Fig. 5/6
- PAB-730.67 Fig. 6/7
- PAB-730.78 Fig. 7/8

Neusilber
German Silver
Metal blanco
Ruolz

BOWMAN

- PAB-731.04 Fig. 0000/000
- PAB-731.03 Fig. 000/00
- PAB-731.02 Fig. 00/0
- PAB-731.01 Fig. 0/1
- PAB-731.12 Fig. 1/2
- PAB-731.23 Fig. 2/3
- PAB-731.34 Fig. 3/4
- PAB-731.45 Fig. 4/5
- PAB-731.56 Fig. 5/6
- PAB-731.67 Fig. 6/7
- PAB-731.78 Fig. 7/8

Silber 800
Steriling silver
plata argent



4/0 3/0 = 0,6 / 7,0 mm
3/0 2/0 = 0,7 / 0,8 mm
2/0 0 = 0,8 / 0,9 mm
0 / 1 = 0,9 / 1,0 mm
1 / 2 = 1,0 / 1,2 mm
2 / 3 = 1,2 / 1,3 mm
3 / 4 = 1,3 / 1,4 mm
4 / 5 = 1,4 / 1,5 mm
5 / 6 = 1,5 / 1,6 mm
6 / 7 = 1,6 / 1,8 mm
7 / 8 = 1,8 / 2,0 mm



BOWMAN

- PAB-732.04 Fig. 0000/000
- PAB-732.03 Fig. 000/00
- PAB-732.02 Fig. 00/0
- PAB-732.01 Fig. 0/1
- PAB-732.12 Fig. 1/2
- PAB-732.23 Fig. 2/3
- PAB-732.34 Fig. 3/4
- PAB-732.45 Fig. 4/5
- PAB-732.56 Fig. 5/6
- PAB-732.67 Fig. 6/7
- PAB-732.78 Fig. 7/8

Neusilber
German Silver
Metal blanco
Ruolz

BOWMAN

- PAB-733.04 Fig. 0000/000
- PAB-733.03 Fig. 000/00
- PAB-733.02 Fig. 00/0
- PAB-733.01 Fig. 0/1
- PAB-733.12 Fig. 1/2
- PAB-733.23 Fig. 2/3
- PAB-733.34 Fig. 3/4
- PAB-733.45 Fig. 4/5
- PAB-733.56 Fig. 5/6
- PAB-733.67 Fig. 6/7
- PAB-733.78 Fig. 7/8

Silber 800
Steriling silver
plata argent



DCR - Instruments

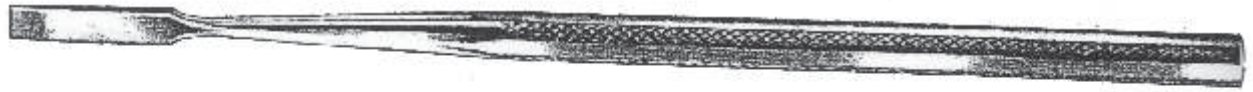

West Lacrimal Chisel
PAB-734.16
Straight 16cm



West Lacrimal Gouge
PAB-735.16
16cm



Freer Periosteal Elevator
PAB-736.18
18cm D/E sharp/blunt 4,5 mm wide



Joseph Periosteal Elevator
PAB-737.16
16 cm 4 mm wide

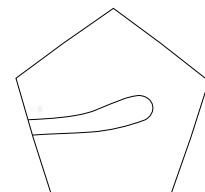
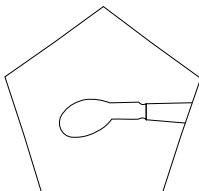

Tenzel D/E Periosteal Elevator
PAB-738.19
195 mm shaft marked at 10mm, 20mm,
and 30mm from tip of dissector end



Luftkanule
 Air injection cannula
 Cannula para aire
 Canule a air

PAB-750.04 27G., 0.4MM
PAB-750.06 23G., 0.6MM



Luftkanule
 Air injection cannula
 Cannula para aire
 Canule a air

PAB-751.04 27g., 0.4MM
PAB-751.06 23g., 0.6MM



PAB-752.04 27G., 0.4MM
PAB-752.06 23G., 0.6MM



Luftkanule
 Air injection cannula
 Cannula para aire
 Canule a air

PAB-753.27 27g
PAB-753.30 30g



Healon injektionskanule
 Healon injection cannula
 Canula para inyeccion de healon
 Canule pour injection d' healon

PAB-754.01



Traenenwegkanule
 Lacrimal cannula
 Canula para canal lacrimal
 Canule a voie lacrymal

ANEL
PAB-755.01

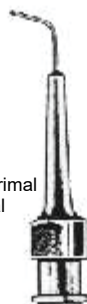

Traenenwegkanule
 Lacrimal cannula
 Canula para canal lacrimal
 Canule a voie lacrymal

ANEL
PAB-756.01



Traenenwegkanule
 Lacrimal cannula
 Canula para canal lacrimal
 Canule a voie lacrymal

PAB-757.01



PAB-758.01



PAB-760.01

Tränenwegkanule, rostfrei
 Lacrimal cannula, SS
 canule lacrimale, inox
 Canule a voies lacrymales, inox

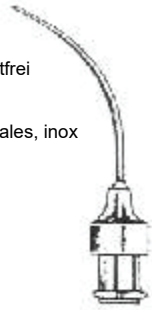

PAB-761.01



PAB-762.01



PAB-763.01

Tränenwegkanule mit 2 seitlichen offnungen
 Lacrimal cannula with 2 lateral holes
 Canula lacrimale con 2 oroficios lateral
 Canule a voies lacrymales avec 2 orifices lateral



MC INTYRE
PAB-764.40



MC INTYRE
PAB-765.21

Retrobulbare Kanule, 40x0.6mm
 Retrobulbar needle, 40mm x 23g
 Canule retrobulbar 40x0.6mm
 Canule retrobulbare, 40x0.6mm



ATKINSON
PAB-766.40



TROUTMAN
PAB-767.01

Alpha - Chymotrypsin Kanule
 Alpha - Chymotrypsin cannula
 Alpha - Chymotrypsin canula
 Alpha - Chymotrypsin canule

Kanule zur Cyklodialyse
 Cyclodialysis cannula
 Canula para ciclodialisis
 Canule pour cyclodialyse



PAB-768.10



PAB-769.15

Kanule zur Cyklodialyse
 Cyclodialysis cannula
 Canula para ciclodialisis
 Canule pour cyclodialyse



PAB-770.11

Offnung rechts
 Right side opening
 Apertura a la derecha
 Ouverture a droite

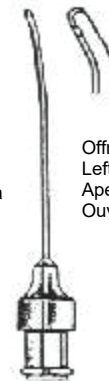

PAB-771.12

Offnung links
 Left side opening
 Apertura a la izquierda
 Ouverture a gauche



PAB-772.31

Kanule zur Cyklodialyse
 Cyclodialysis cannula
 Canula para ciclodialisis
 Canule pour cyclodialyse

• Eye surgery • Augen-Instrumentarium • Oftalmologia

Spulkanule fur radiale keratotomie
 Radial Keratotomy irrigating cannula
 Canula para irrigacion para queratotomia radial
 Canule irrigatoire poue la keratotomie radiale



SHEPARD
PAB-773.01

Spulkanule, seitliche offnung
 irrigating cannula, lateral opening
 Canula para irrigacion, orofocio lateral
 Canule irrigatoire, orifice lateral



WEST
PAB-774.20 20 g
PAB-774.23 23 g

Sondenkanule
 Probe cannula
 Canula tipo sonda
 Canule - sonde



BANGERTER
PAB-775.46 40 X 0.6mm
PAB-775.48 40 X 0.8mm
PAB-775.66 60 x 0.6mm
PAB-775.68 60 x 0.8mm

Augenbrause
 Irrigating anterior chamber cannula
 Canula para irrigacion de camara anterior
 Canule irrigatoire multitrous



CRANZ
PAB-776.90

Kortex - Extractor
 Cortex Extractor
 Extractor para corteza
 Extracteur de cortex



MC INTYRE
PAB-777.10 **PAB-778.11**
 Gerade
 straight
 recto
 droit
 Gewinkelt
 angled
 anguloso
 coudee



MC INTYRE
PAB-779.23 23 g
PAB-779.26 26 g
PAB-779.30 30 g



MC INTYRE
PAB-780.23 23 g
PAB-780.26 26 g
PAB-780.30 30 g



KNOLLE
PAB-781.23 23 g
PAB-781.30 30 g



SIMCO
PAB-782.13 13 mm
PAB-782.21 21mm

Spulkanule mit Irishakchen
 Irrigating iris hook
 Cancho oros de irrigacion
 irrigateur avec crochet pour l' iris



MC INTYRE
PAB-783.20 **PAB-783.21**
 Gerade
 straight
 recto
 droit
 Gewinkelt
 angled
 anguloso
 coudee

Kapselpolierer, diamantbeschichtet
 Capsule polisher, diamond dusted
 Pulidor para capsula, con diamante
 Polisher capsulaire, diamante



KRATZ
PAB-785.01

Kapselpolierer, diamantbeschichtet
 Posterior capsule polisher, diamond dusted
 Pulidor para capsula, con diamante
 Polisher capsulaire, diamante



RUBMAN - KATZIN
PAB-786.01



JENSEN
PAB-787.21
PAB-787.25

Kapselpolierer, diamantbeschichtet
 Posterior capsule polisher, diamond dusted
 Pulidor para capsula, con diamante
 polissoir capsulaire, diamante



KNOLLE
PAB-788.23 23 g
PAB-788.30 30 g



KNOLLE
PAB-789.23 23 g
PAB-789.30 30 g



Saugkeile
 Absorbing points
 Cunas absorbentes
 coins absorbents

Packung 10 Stuck, steril
 Package of 10 ea., Sterile
 Paquete de 10 piezas, esteril
 Boite a 10 pieces, sterile

PAB-790.00



Handhriff
 Infusion handle
 Mango para infusion
 Manche pour perfusion

MC INTYRE
PAB-791.60



Handhriff
 Infusion handle
 Mango para infusion
 Manche pour perfusion

KANSAS
PAB-792.70

Kapselpolierer, diamantbeschichtet
 Capsule polisher, diamond dusted
 Pulidor para capsula, con diamante
 Polisher capsulaire, diamante



KRATZ
PAB-785.01

Kapselpolierer, diamantbeschichtet
 Posterior capsule polisher, diamond dusted
 Pulidor para capsula, con diamante
 Polisher capsulaire, diamante



RUBMAN - KATZIN
PAB-786.01



JENSEN
PAB-787.21
PAB-787.25

Kapselpolierer, diamantbeschichtet
 Posterior capsule polisher, diamond dusted
 Pulidor para capsula, con diamante
 polissoir capsulaire, diamante



KNOLLE
PAB-788.23 23 g
PAB-788.30 30 g



KNOLLE
PAB-789.23 23 g
PAB-789.30 30 g



Saugkeile
 Absorbing points
 Cunas absorbentes
 coins absorbents

Packung 10 Stuck, steril
 Package of 10 ea., Sterile
 Paquete de 10 piezas, esteril
 Boite a 10 pieces, sterile

PAB-790.00



Handhriif
 Infusion handle
 Mango para infusion
 Manche pour perfusion

MC INTYRE
PAB-791.60



Handhriif
 Infusion handle
 Mango para infusion
 Manche pour perfusion

KANSAS
PAB-792.70



Holth Corneoscleral Punch

Overall length 87mm

PAB-795.10 1,0 mm wide

PAB-790.15 1,5 mm wide

PAB-797.20, 2,0 mm wide

Professional

Envision Life

Professional Hospital Furnishers



19-A (N), Industrial Estate, Sialkot-51310, Pakistan.

Tel. +92 52 355 8074, 325 6440
Email: info@phfworld.com

www.phfworld.com