



Plastic Surgery *Instruments*

Instrumente für plastische Chirurgie
Instruments de chirurgie plastique
Instrumentos de cirugía plástica
Strumenti di chirurgia plastica

INDEX

01	Marking And Measuring Instruments	01 To 04
02	Scissors	05 To 32
03	Scalpels, Dermatomes, Instruments for Auricular Plastic	33 To 38
04	Forceps	39 To 46
05	Hemostatic Forceps	47 To 50
06	Needle Holders	51 To 60
07	Wires and Wire Instruments, Elevators, Mallets	61 To 70
08	Chisels, Elevators	71 To 82
09	Retactors	83 To 110
10	Rhinoplasty Instruments	111 To 128
11	Liposuction Cannula & Accessories	129 To 162
12	Mammoplasty	163 To 174
13	Brow Lift Instruments	175 To 184
14	Index	185 To 191

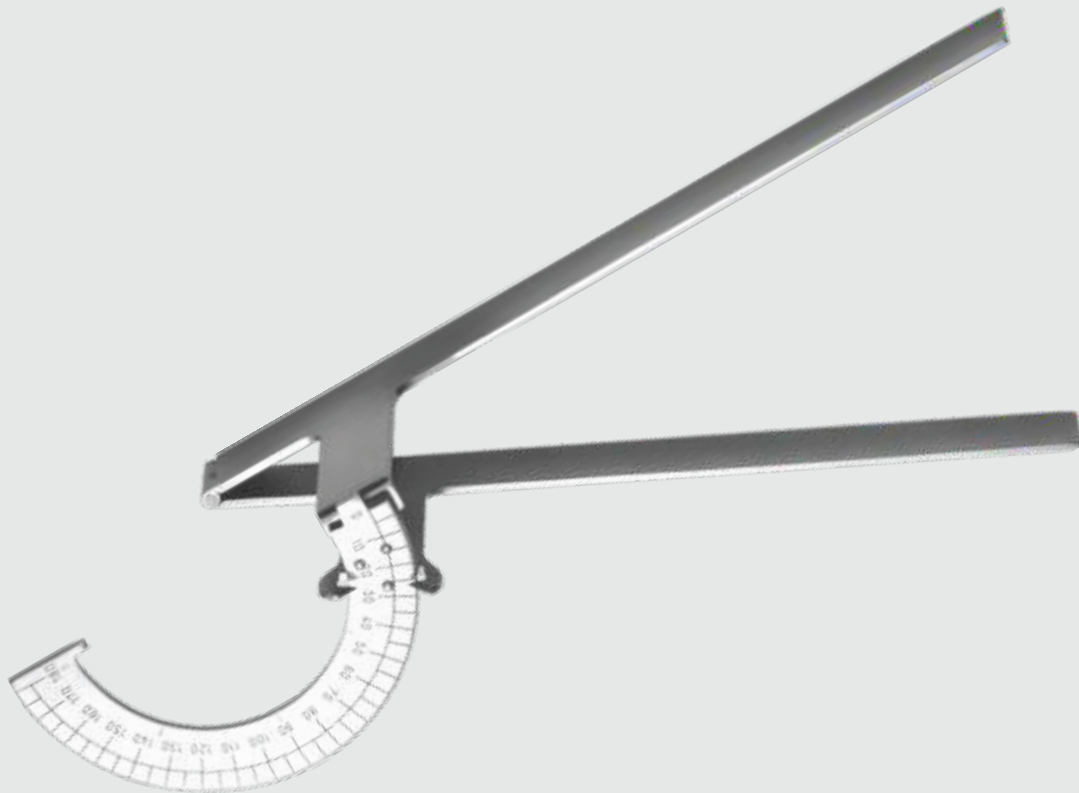

Marking and Measuring Instruments

Markierungs- und Messinstrumente

Instrumentos para marcar y medir

Instrumentes à mesurer et marquer

Marking and
Measuring Instruments

Markierungs- und
Messinstrumente

Instrumentos para
marcar y medir

Instruments à
mesurer et marquer



Ruler (stainless steel)
Stahl-Messstäbe (rostfrei)
Reglas de acero (inoxidable)
Règles en acier (inoxydable)
Righe graduate in acciaio
(inossidabile)
graduated in mm
and inches
graduirt in mm
und Zoll
graduado en mm
y pulgadas
graduée en mm
et pouces
graduato in mm
e pollici

PA-37.15
15 cm / 6"

PA-37.20
20 cm / 8"

PA-37.30
30 cm / 11¾"

PA-37.50
50 cm / 19¾"

Flexometer



Fold up
zusammenlegbar
plegable
pliable
pieghevole

MOLTGEN
PA-38.10
24 cm / 9½"

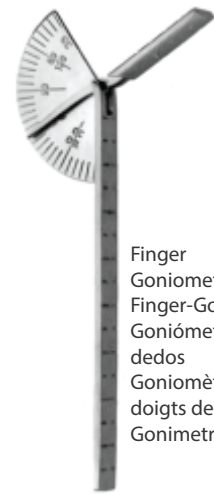

Finger
Goniometer
Finger-Goniometer
Goniómetro para
dedos
Goniomètre pour
doigts de mains
Gonimetro per dita

PA-38.30
13 cm / 5¼"



Jameson

Calipers
Schieblehren
Calibradores
Pieds à coulisse
Calibri micrometrici

PA-38.40
10 cm / 4"



Thorpe

PA-38.41
11 cm / 4¼"



JOSEPH
PAN-30.47
17 cm / 6¾"

graduated in mm
graduirt in mm
graduado en mm
graduée en mm
graduata in mm

Marking and
Measuring Instruments

Markierungs- und
Messinstrumente

Instrumentos para
marcar y medir

Instruments à
mesurer et marquer



Bone Bow Spacer
Knochen-Messzirkel
Compás de medición para hueso
compas à os
Compasso per ossa

PA-38.44
19.5 cm / 7¾"



Pen
Feder
Pluma
Plume
Piuma
PA-39.02

Pen Holder
Federhalter
Porta-plumas
Porte-plume
Porta-piuma
PA-39.01
13 cm / 5 1/8"

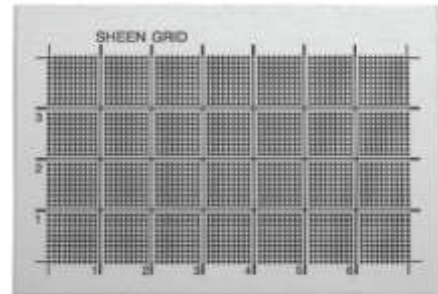

Sheen Grid
PA-40.40
Autoclavable,
Grid Dimensions are
40 x 70 mm

Calipers
Messzirkel
Compases
Compas
Compassi



CASTROVIEJO
PAB-82.33
7 cm / 2¾"



CASTROVIEJO
PAB-82.41
9 cm / 3¾"



CASTROVIEJO
PAB-82.42
18 cm / 7 1/8"



CASTROVIEJO
PAB-82.43
18 cm / 7 1/8"

Measuring Range

Marking and
Measuring Instruments

Markierungs- und
Messinstrumente

Instrumentos para
marcar y medir

Instruments à
mesurer et marquer



PITANGUY
PP-50.14
14 cm / 5½"



PITANGUY
PAN-64.30
16 cm / 6¼"

Facelift Marker
Facelift-Markierer
Marcador para facelift
Marqueur pour facelift
Marcatore per facelift



MARTEN FLAP MARKER
PAN-64.24 with ratchet
PAN-64.25 without ratchet
14.5 cm / 5¾"



D ASSUMPCAO
PAN-64.36 with ratchet
PAN-64.37 without ratchet
16 cm / 6¼"

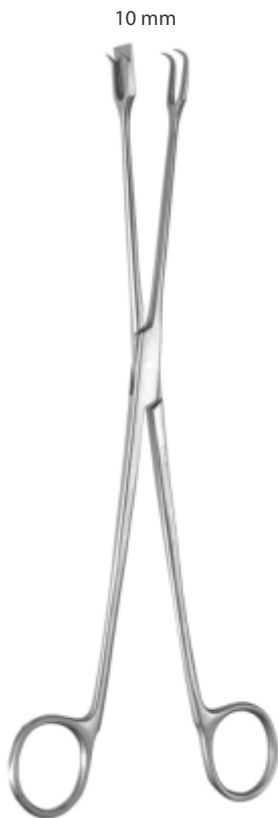

D ASSUMPCAO
PAN-64.55 with ratchet
PAN-64.56 without ratchet
25.5 cm / 10"

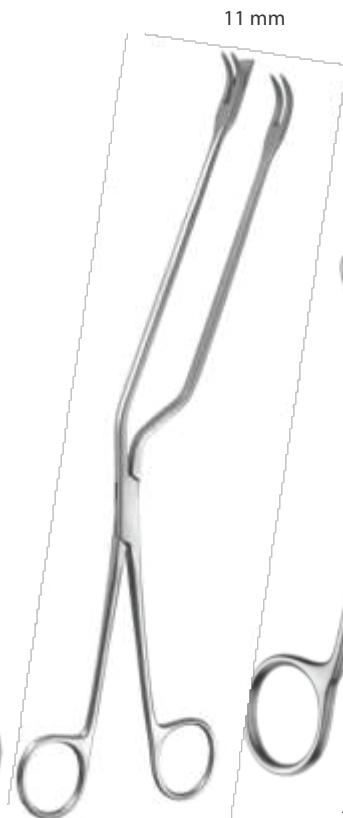

LOCKWOOD
PAN-65.31
with angled hinge
31 cm / 12¼"

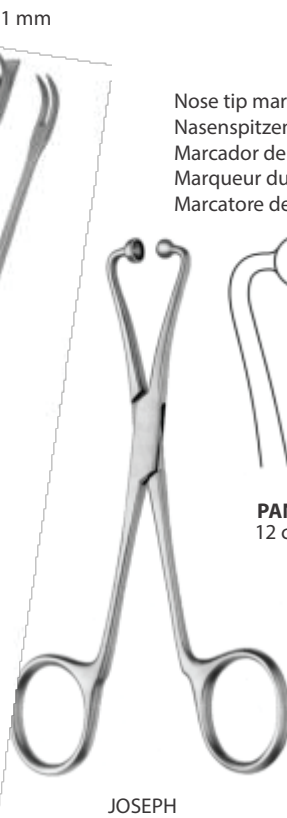

JOSEPH

Nose tip marker
Nasenspitzenmarkierer
Marcador de la punta de la nariz
Marqueur du bout du nez
Marcatore della punta del naso



PAN-30.12
12 cm / 4¾"



PAN-30.14
14.5 cm / 5¾"

Pin
Pin
Perno
Pivot
Perno



KRETSCHMER
PAN-84.00

Holder
Halterung
Soporte
Support
Sostegno



KRETSCHMER
PAN-84.05
15 mm



Scissors
Scheren
Tijeras
Ciseaux

Delicate Dissecting
Scissors

Feine
Präparierscheren

Tijeras finas
para disección

Ciseaux délicats
pour dissection

PROFESSIONAL Supercut scissors with their uniquely ground edges have with ultimate cutting efficiency. The special micro serrations in conjunction with the uniquely ground edges ensure precise, fine and minimally traumatising cuts. Professional supercut scissors have fully gold-coloured screw for ease of identification.

The range of supercut scissors from PROFESSIONAL comprises all models used routinely by surgeons: scissors for delicate and extremely delicate dissecting, e.g. Iris and Micro, models according to Metzenbaum in all possible lengths and designs, e.g. in a slim version for especially fine cutting to name but a few.

The supercut scissors can also be supplied with "TC" welded cutting edges of solid tungsten carbide alloy. The junction between the steel of the scissors and the tungsten carbide is seamless and homogenous. The welded cutting edges of solid tungsten carbide alloy guarantee excellent cutting quality and long life-span.

Identification:

PROFESSIONAL TC scissors:
gold-coloured rings



PROFESSIONAL supercut scissors:
Black quoted shafts



PROFESSIONAL supercut plus line scissors:
one shaft gold plated and
one shaft black quoted



Delicate Dissecting
Scissors

Feine
Präparierscheren

Tijeras finas
para disección

Ciseaux délicats
pour dissection



IRIS

standard
supercut
TC
supercut plus



9cm/3 1/2"
PC-01.09



10.5cm/4 1/4"
PC-01.10
PC-01.110



11.5cm/4 1/2"
PC-01.11
PC-01.111
PC-05.61
PC-05.161



12.5cm/5"
PC-01.12



IRIS

supercut
TC
supercut plus



straight
11.5 cm / 4 1/2"
PC-01.171
PC-05.71
PC-05.171



curved
11.5 cm / 4 1/2"
PC-02.171
PC-06.71
PC-06.171



MICRO IRIS

standard
supercut



straight
9 cm / 3 1/2"
PC-03.30



curved
9 cm / 3 1/2"
PC-04.30
PC-04.130



IRIS

standard
supercut
TC
supercut plus



9cm/3 1/2"
PC-02.09



10.5cm/4 1/8"
PC-02.10
PC-02.110



11.5cm/4 1/2"
PC-02.11
PC-02.111
PC-06.61
PC-06.161



12.5cm/5"
PC-02.12
PC-02.112

Delicate Dissecting
Scissors

Feine
Präparierscheren

Tijeras finas
para disección

Ciseaux délicats
pour dissection



STEVENS

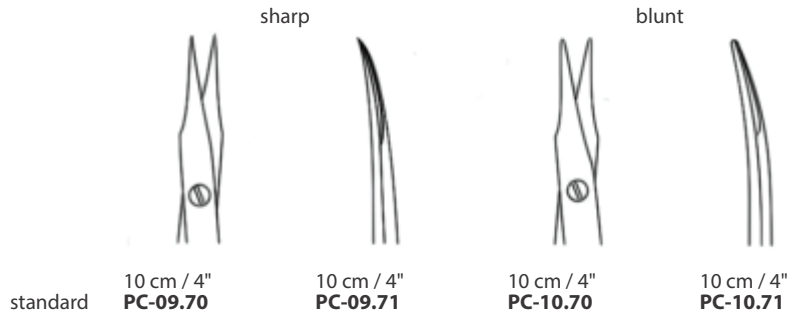

STEVENS

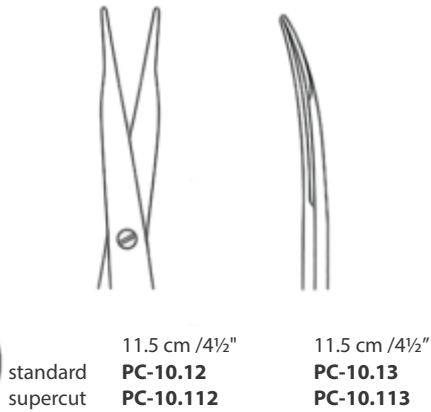

STEVENS



LEXER BABY

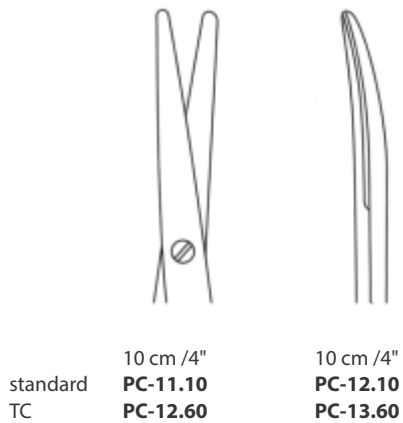

KNAPP

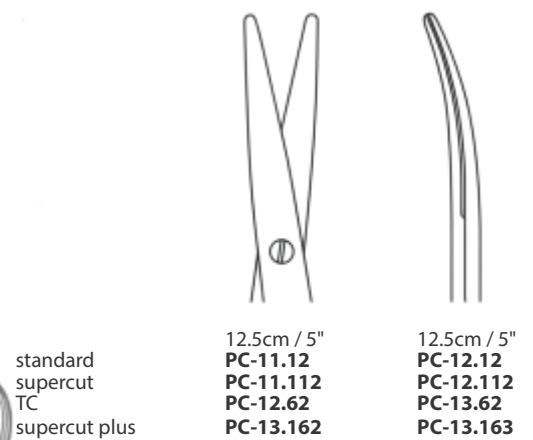

Delicate Dissecting
Scissors

Feine
Präparierscheren

Tijeras finas
para disección

Ciseaux délicats
pour dissection



KNAPP

standard
supercut

12 cm / 4¾"
PC-11.32
PC-11.132

sharp



12 cm / 4¾"
PC-12.32
PC-12.132

blunt



12 cm / 4¾"
PC-11.52

12 cm / 4¾"
PC-12.52



KNAPP

standard

10 cm / 4"
PC-11.70



10 cm / 4"
PC-12.70



standard

9.5cm / 3¾"
PC-12.90



standard
supercut
TC



11.5cm / 4¾"
PAB-196.42
PAB-196.142
PAB-196.62

11.5cm / 4¾"
PAB-196.43
PAB-196.143
PC-196.63

Dissecting Scissors

Tijeras para disección

Ciseaux pour dissection

Forbici per dissezione



MAYO

standard
supercut
TC
supercut plus

14 cm / 5½"
PC-24.14
PC-24.114
PC-24.64
PC-24.164

14 cm / 5½"
PC-25.14
PC-25.114
PC-25.64
PC-25.164

17 cm / 6¾"
PC-24.17
PC-24.117
PC-24.67
PC-24.167

17 cm / 6¾"
PC-25.17
PC-25.117
PC-25.67
PC-25.167

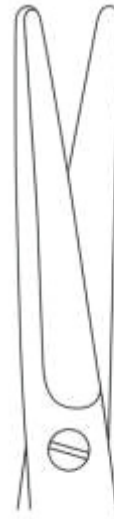

MAYO STILLE

standard
supercut
TC
supercut plus

15 cm / 6"
PC-30.15
PC-30.115
PC-31.65
PC-31.165

17 cm / 6¾"
PC-30.17
PC-30.117
PC-31.67
PC-31.167

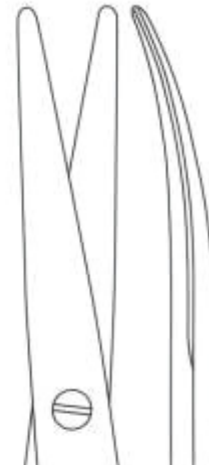
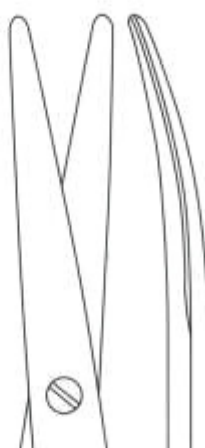

Delicate Dissecting
Scissors

Feine
Präparierscheren

Tijeras finas
para disección

Ciseaux délicats
pour dissection



MAYO LEXER

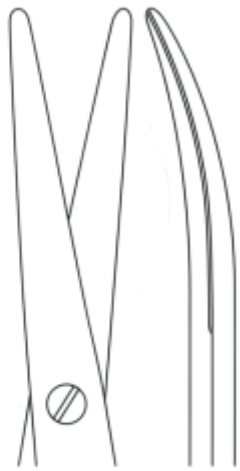

supercut
TC
supercut plus

16.5 cm / 6½"
PC-32.187
PC-32.97
PC-32.197



LEXER



standard
supercut
TC
supercut plus

16 cm / 6¼"
PC-32.16
PC-32.116
PC-34.96
PC-34.196



16 cm / 6¼"
PC-32.17
PC-32.117
PC-35.96
PC-35.196



BABY METZENBAUM



standard
supercut
TC
supercut plus

11.5 cm / 4½"
PC-36.11
PC-36.111
PC-36.61
PC-36.161



11.5 cm / 4½"
PC-37.11
PC-37.111
PC-37.61
PC-37.161

Delicate Dissecting
Scissors

Tijeras finas para
disección

Ciseaux délicats pour
dissection

Forbici delicate per
dissezione



METZENBAUM

standard
supercut
TC
supercut plus



14 cm / 5½"
PC-36.14
PC-36.114
PC-36.64
PC-36.164



18 cm / 7 1/8"
PC-38.18
PC-38.118
PC-38.68
PC-38.168



20 cm / 8"
PC-38.20
PC-38.120
PC-38.70
PC-38.170



BABY METZENBAUM

standard
supercut
TC
supercut plus

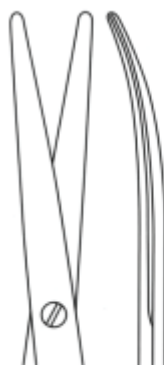

14 cm / 5½"
PC-37.14
PC-37.114
PC-37.64
PC-37.164

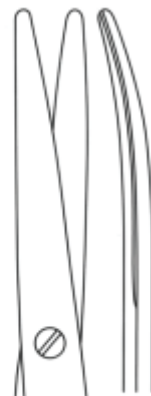

15 cm / 6"
PC-37.15
PC-37.115
PC-39.68
PC-39.168

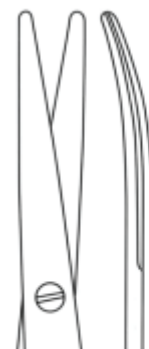

18 cm / 7 1/8"
PC-39.18
PC-39.118
PC-39.70
PC-39.170



20 cm / 8"
PC-39.20
PC-39.120

Delicate Dissecting
Scissors

Feine
Präparierscheren

Tijeras finas
para disección

Ciseaux délicats
pour dissection



MINI METZENBAUM

supercut



9 cm / 3½"
PC-36.109



9 cm / 3½"
PC-37.109



NELSON METZENBAUM

standard
supercut
TC
supercut plus



23 cm / 9"
PC-40.23
PC-40.123
PC-40.73
PC-40.173



26 cm / 10¼"
PC-40.26
PC-40.126



30 cm / 11¾"
PC-40.30
PC-40.130

Delicate Dissecting
Scissors

Tijeras finas para
disección

Ciseaux délicats pour
dissection

Forbici delicate per
dissezione

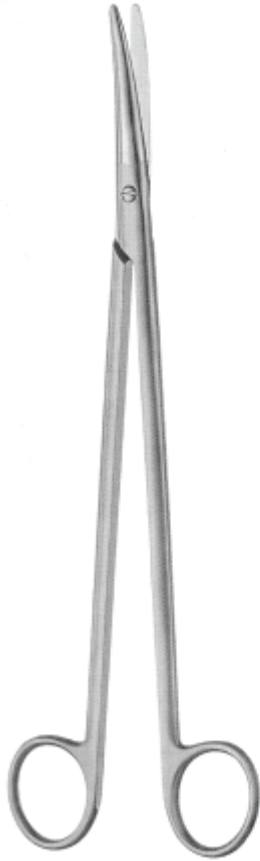

NELSON METZENBAUM

standard
supercut
TC
supercut plus



23 cm / 9"
PC-41.23
PC-41.123
PC-41.73
PC-41.173



26 cm / 10¼"
PC-41.26
PC-41.126
PC-41.76
PC-41.176



30 cm / 11¾"
PC-41.30
PC-41.130
PC-41.80
PC-41.180



METZENBAUM slim

standard
supercut
TC
supercut plus



14 cm / 5½"
PC-42.14
PC-42.114
PC-42.64
PC-42.164



18 cm / 7 1/8"
PC-44.18
PC-44.118
PC-44.68
PC-44.168



20 cm / 8"
PC-44.20
PC-44.120
PC-44.70
PC-44.170



23 cm / 9"
PC-44.23
PC-44.123
PC-44.73
PC-44.173

Delicate Dissecting
Scissors

Feine
Präparierscheren

Tijeras finas
para disección

Ciseaux délicats
pour dissection



METZENBAUM slim

standard
supercut
TC
supercut plus



14 cm / 5½"
PC-43.14
PC-43.114
PC-43.64
PC-43.164



18 cm / 7 1/8"
PC-45.18
PC-45.118
PC-45.68
PC-45.168



20 cm / 8"
PC-45.20
PC-45.120
PC-45.70
PC-45.170



23 cm / 9"
PC-45.23
PC-45.123
PC-45.73
PC-45.173



METZENBAUM slim

supercut



26 cm / 10¼"
PC-45.176



28.5 cm / 11¼"
PC-45.178

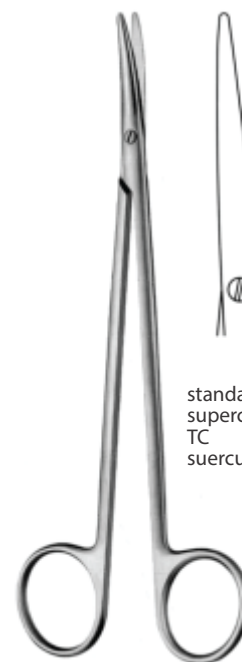

TOENNIS ADSON

standard
supercut
TC
supercut plus



18 cm / 7 1/8"
PC-50.18
PC-50.118
PC-50.68
PC-50.168

Delicate Dissecting
Scissors

Tijeras finas para
disección

Ciseaux délicats pour
dissection

Forbici delicate per
dissezione



METZENBAUM

supercut
TC
supercut plus



18 cm / 7 1/8"
PC-46.168
PC-46.78
PC-46.178

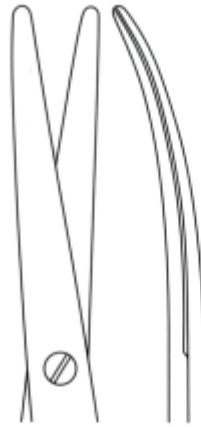

20 cm / 8"
PC-46.170
PC-46.80
PC-46.180

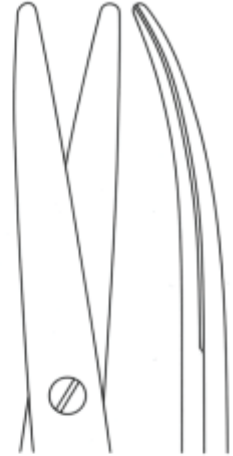

23 cm / 9"
PC-46.173
PC-46.83
PC-46.183



METZENBAUM FREEMAN

supercut



18 cm / 7 1/8"
PC-47.168



20 cm / 8"
PC-47.170



23 cm / 9"
PC-47.173

Delicate Dissecting
Scissors

Feine
Präparierscheren

Tijeras finas
para disección

Ciseaux délicats
pour dissection



KELLY

standard
supercut
TC
supercut plus



16 cm / 6¼"
PC-46.16
PC-46.116
PC-46.66
PC-46.166



16 cm / 6¼"
PC-47.16
PC-47.116
PC-47.66
PC-47.166



BRUSER KELLY



supercut
16 cm / 6¼"
PC-48.116



16 cm / 6¼"
PC-49.116



SIEGERT

undermining scissors



standard
TC

11.5cm / 4½"
PC-58.131
PC-58.61



11.5cm / 4½"
PC-58.132
PC-58.62



RAGNELL (KILNER)

standard
supercut
TC
supercut plus



13 cm / 5 1/8"
PC-59.13
PC-59.113
PC-59.63
PC-59.163



15 cm / 6"
PC-59.15
PC-59.115
PC-59.65
PC-59.165



18 cm / 7 1/8"
PC-59.18
PC-59.118
PC-59.68
PC-59.168



20 cm / 8"
PC-59.20

Delicate Dissecting
Scissors

Tijeras finas para
disección

Ciseaux délicats pour
dissection

Forbici delicate per
dissezione



GREENBERG PAR

supercut
supercut plus



11.5 cm / 4½"
PC-60.122
PC-61.122



standard
supercut



11 cm / 4 3/8"
PC-64.111
PC-64.111



11 cm / 4 3/8"
PC-64.112
PC-64.112



JABELEY

standard
supercut



13 cm / 5 1/8"
PC-64.113
PC-64.113



13 cm / 5 1/8"
PC-64.114
PC-64.114



JOSEPH

standard
supercut



15cm / 6"
PC-65.114
PC-65.114



15cm / 6"
PC-66.114
PC-66.114

Delicate Dissecting
Scissors

Feine
Präparierscheren

Tijeras finas
para disección

Ciseaux délicats
pour dissection



PECK JOSEPH

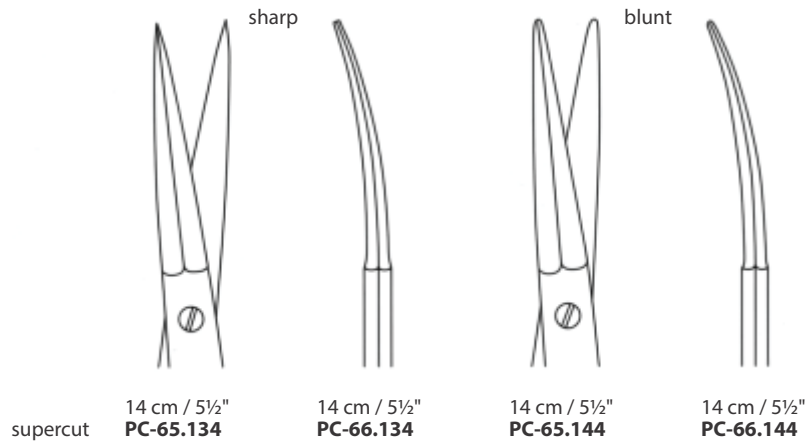

"slim"

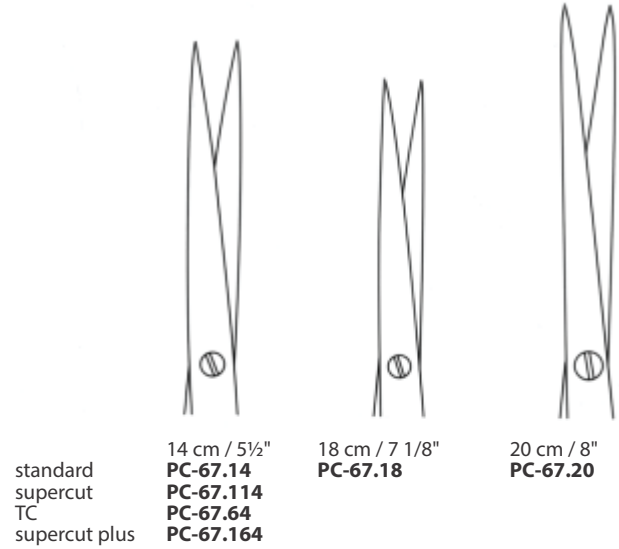

"slim"

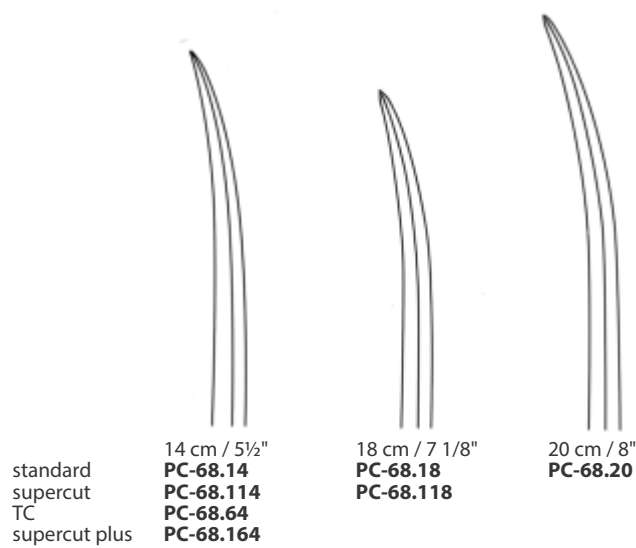

Delicate Dissecting
Scissors

Tijeras finas para
disección

Ciseaux délicats pour
dissection

Forbici delicate per
dissezione



JAMESON



supercut
15cm / 6"
PC-69.117



18 cm / 7 1/8"
PC-70.118



REYNOLDS (JAMESON)



standard
12 cm / 4 3/4"
PC-72.12
blunt



14 cm / 5 1/2"
PC-72.14
blunt



16 cm / 6 1/4"
PC-72.16
blunt



18 cm / 7 1/8"
PC-72.18
blunt



REYNOLDS (JAMESON)



standard
supercut
12 cm / 4 3/4"
PC-73.12
PC-73.112
blunt



14 cm / 5 1/2"
PC-73.14



16 cm / 6 1/4"
PC-73.16
PC-73.116
blunt



18 cm / 7 1/8"
PC-73.18
PC-73.118
blunt

Delicate Dissecting
Scissors

Feine
Präparierscheren

Tijeras finas
para disección

Ciseaux délicats
pour dissection



undermining scissors



supercut **16.5 cm / 6½"**
PC-74.116

16.5 cm / 6½"
PC-74.126

20.5 cm / 8"
PC-74.120

20.5 cm / 8"
PC-74.130

FANOUS



GORNEY

GORNEY-FREEMAN

flat tips

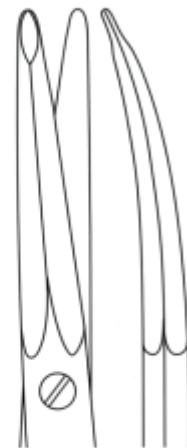

GORNEY

supercut	17cm / 6¾" PC-77.127	19 cm / 7½" PC-77.129	23 cm / 9" PC-77.133
TC	PC-77.67	PC-77.69	PC-77.73
supercut plus	PC-77.227	PC-77.229	PC-77.233

GORNEY-FREEMAN

supercut	17cm / 6¾" PC-80.117	19 cm / 7½" PC-80.119	23 cm / 9" PC-80.123
TC	PC-80.37	PC-80.39	PC-80.43
supercut plus	PC-80.217	PC-80.219	PC-80.233

Delicate Dissecting
Scissors

Tijeras finas para
disección

Ciseaux délicats pour
dissection

Forbici delicate per
dissezione

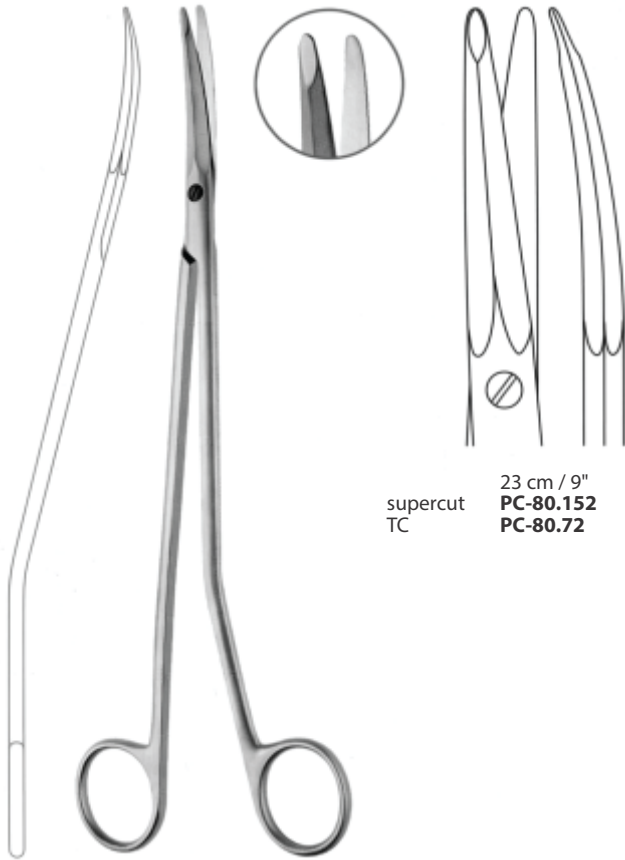

supercut
TC

23 cm / 9"
PC-80.152
PC-80.72



LITTLER



standard

12 cm / 4¾"
PC-80.01

GORNEY-FREEMAN



KAYE



supercut
TC

15 cm / 6"
PC-81.115



17cm / 6¾"
PC-81.117
PC-81.37

Delicate Dissecting
Scissors

Feine
Präparierscheren

Tijeras finas
para disección

Ciseaux délicats
pour dissection



KAYE

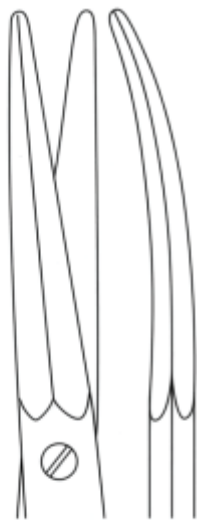

supercut
TC

19 cm / 7½"
PC-81.119
PC-81.39

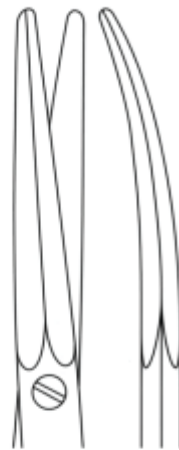

23 cm / 9"
PC-81.123
PC-81.43

Blepharoplasty scissors



KAYE



supercut

11.5 cm / 4½"
PC-81.132

Gold Tip



supercut

20 cm / 8"
PC-83.220

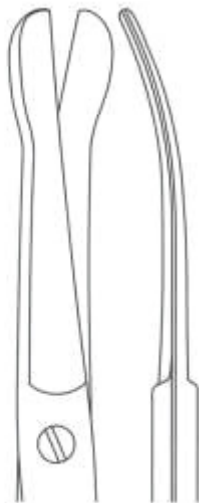

supercut

20 cm / 8"
PC-83.230

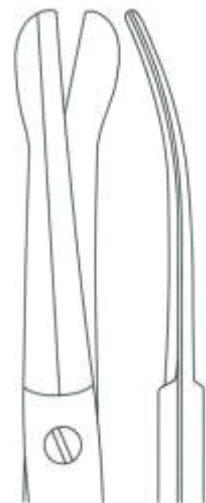

Stitch Scissors

Tijeras para hilos

Ciseaux à fils

Forbici taglia-fili



FOX

standard
supercut
TC
supercut plus



13 cm / 5 1/8"
PC-90.13
PC-90.113
PC-90.63
PC-90.163



13 cm / 5 1/8"
PC-91.13
PC-91.113
PC-91.63
PC-91.163



SPENCER



standard
TC

9 cm / 3 1/2"
PS-19.09



10.5 cm / 4 1/8"
PS-20.10
PS-20.60



12 cm / 4 3/4"
PS-20.12
PS-20.62



LITTAUER

standard



13 cm / 5 1/8"
PS-21.13



KELLY

standard



15 cm / 6"
PS-21.35

Rhinoplasty Scissors

Tijeras para ringoplastia

Ciseaux pour rhinoplastie

Forbici per rinoplastica



O'BRIEN

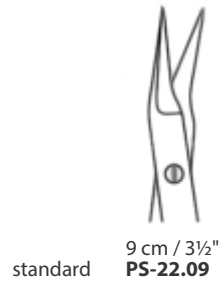

standard

9 cm / 3½"
PS-22.09



wire cutting scissors

serrated cutting edge

hard wire Ø 0.8mm max
soft wire Ø 1.2mm max

UNIVERSAL "TC"
PS-24.12
12 cm / 4¾"

wich micro serration & tungsten carbide edge



Ligature Scissors



TC

14.5cm / 5¾"
PS-36.84



18 cm / 7¼"
PS-36.88



23 cm / 9"
PS-36.93

Rhinoplasty Scissors

Tijeras para ringoplastia

Ciseaux pour rhinoplastie

Forbici per rinoplastica



DEAN

standard
supercut

17 cm / 6¾"
PAK-25.17
PAK-25.117



HEYMANN

standard

20 cm / 8"
PAM-17.20



HEYMANN

standard
supercut

17 cm / 6¾"
PAM-17.18



serrated cutting edge

17 cm / 6¾"
PAM-17.19



18 cm / 7 1/8"
PAM-17.122



Rhinoplasty Scissors

Tijeras para ringoplastia

Ciseaux pour rhinoplastie

Forbici per rinoplastica



standard
supercut
supercut plus

FOMON



13 cm / 5 1/8"
PAM-50.13
PAM-50.113
PAM-50.163



supercut

WALTER



14 cm / 5 1/2"
PAM-50.14

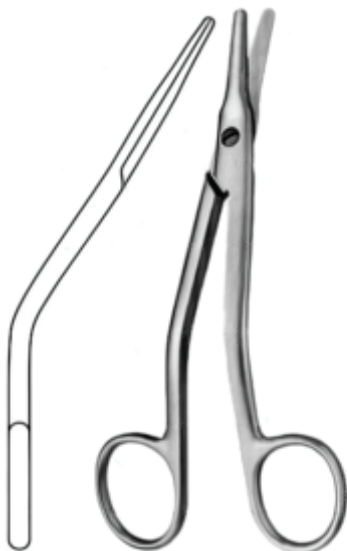

supercut
TC
supercut plus

WALTER COTTLE



16 cm / 6 1/4"
PAM-50.16
PAM-50.77
PAM-50.177



standard
supercut
TC
supercut plus

COTTLE



16cm / 6 1/4"
PAM-51.16
PAM-51.116
PAM-51.36
PAM-51.136

Rhinoplasty Scissors

Tijeras para ringoplastia

Ciseaux pour rhinoplastie

Forbici per rinoplastica



GIUNTA

TC

13.5 cm / 5 3/8"
PAM-51.63



CONVERSE

outer edges
semi sharp

standard

13.5 cm / 5 3/8"
PAN-43.13



COTTLE MASING

standard



10 cm / 4"
PAN-46.10



10 cm / 4"
PAN-47.10



COTTLE

Bulldog Scissors

standard



11.5 cm / 4 3/4"
PAN-49.12



CINELLI

standard



11 cm / 4 3/8"
PAN-51.11



FOMON

with outer cutting,
both sides sharp

standard



12.5 cm / 5"
PAN-51.43

Rhinoplasty Scissors

Tijeras para ringoplastia

Ciseaux pour rhinoplastie

Forbici per rinoplastica

Cartilage scissors



MCINDOE



standard
18 cm / 7"
PAN-78.18



AUFRICHT

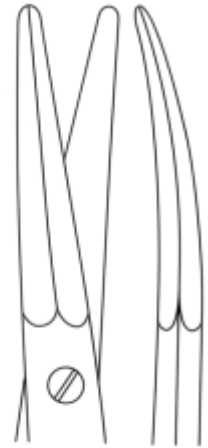

standard
supercut
TC
supercut plus

14 cm / 5½"
PAN-51.34
PAN-51.134
PAN-51.64
PAN-51.164



FOMON



standard
12.5 cm / 5"
PAN-51.34



FANOUS



standard
supercut

14 cm / 5½"
PAN-52.14
PAN-52.114

Rhinoplasty Scissors

Tijeras para ringoplastia

Ciseaux pour rhinoplastie

Forbici per rinoplastica

Nasal Septum Scissors

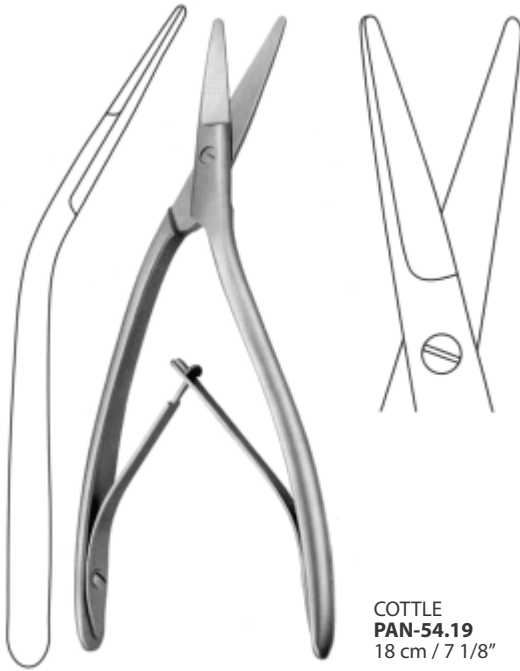

COTTLE
PAN-54.19
18 cm / 7 1/8"

Nasal Septum Scissors

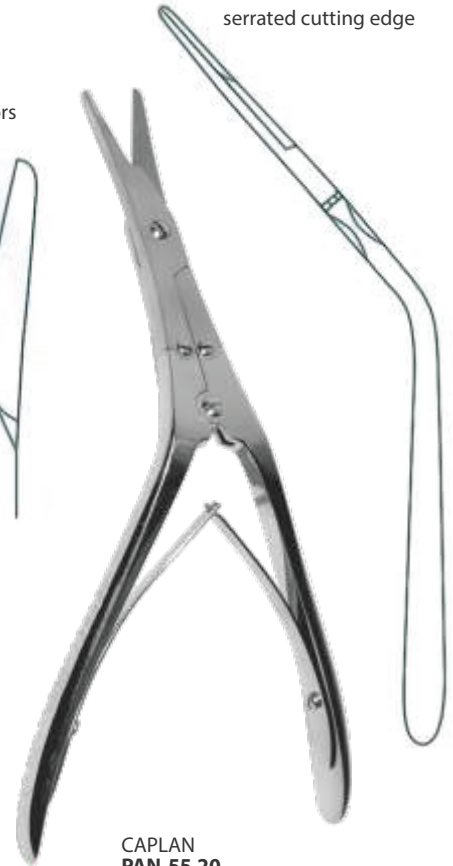

CAPLAN
PAN-55.20
20 cm / 8"



OBWEGESER



21cm / 8 1/4"
PAN-56.31



21cm / 8 1/4"
PAN-56.32



21cm / 8 1/4"
PAN-56.33

Nasal ridge scissors

Micro Scissors

Micro tijeras

Micro ciseaux

Micro forbici



micro 2000

standard

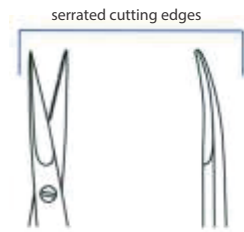

15 cm / 6"
PD-01.22

15 cm / 6"
PD-01.23

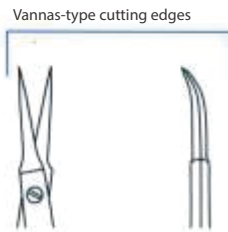

15 cm / 6"
PD-01.30

15 cm / 6"
PD-01.31



micro 2000

standard
supercut



15 cm / 6"
PD-01.20
PD-01.120



15 cm / 6"
PD-01.21
PD-01.121



standard
supercut



15 cm / 6"
PD-01.74
PD-01.174



15 cm / 6"
PD-01.75

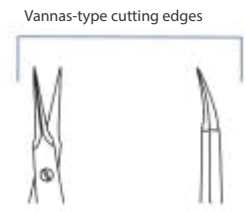

15 cm / 6"
PD-01.76

15 cm / 6"
PD-01.77

Round handle



Micro Scissors

Micro tijeras

Micro ciseaux

Micro forbici



standard

Jacobson Micro 2000



18 cm / 7¼"
PD-07.20



18 cm / 7¼"
PD-07.21



18 cm / 7¼"
PD-07.25



18 cm / 7¼"
PD-07.26



standard



23 cm / 9"
PD-08.02

Round handle





Scalpels
Bisturies
Bistouris
Bisturi

Dermatomes
Dermatomos
Dermatomes
Dermatomi

Instruments for Auricular Plastic
Instrumentos para la otoplastia
Instruments pour l'otoplastie
Strumenti per l'otoplastica

Scalpels

Bisturies

Bistouris

Bisturi



PE-03.10
Fig. 10



PE-03.11
Fig. 11



PE-03.12
Fig. 12



PE-03.32
Fig. 12d



PE-03.15
Fig. 15



PE-03.35
Fig. 15c



PE-03.35
Fig. 15c



PE-03.23
Fig. 23

Packing unit 100 pieces, sterile



PE-04.03
No.3
12.5 cm / 5"



PE-05.07
No.7
16.5 cm / 6½"



PE-06.17
No.7K
12 cm / 4¾"



PE-07.13
No.3L
21 cm / 8¼"



PE-08.23
No.3LA
20.5 cm / 8"



PE-10.40
15.5 cm / 6 1/8"

Scalpels

Bisturies

Bistouris

Bisturi



PE-10.45
22.5 cm / 9"



PE-10.53
27 cm / 10¾"



PE-10.61
21 cm / 8¼"



PE-10.63
15.5 cm / 6 1/8"



PE-10.64
21 cm / 8¼"

Scalpels

Bisturies

Bistouris

Bisturi



PE-10.92
Fig. 62



PE-10.94
Fig. 64



PE-10.95
Fig. 65



PE-10.97
Fig. 67

Packing unit 12 pieces, sterile



LANDOLT
PE-10.86
21 cm / 8 1/4"



LANDOLT
PE-10.87
25 cm / 10"



PE-10.90 13 cm / 5 1/8"
PE-10.91 15.5 cm / 6 1/8"

Instruments for
Auricular Plastic

Instrumentos para
la otoplastia

Instruments pour
l'otoplastie

Strumenti per
l'otoplastica

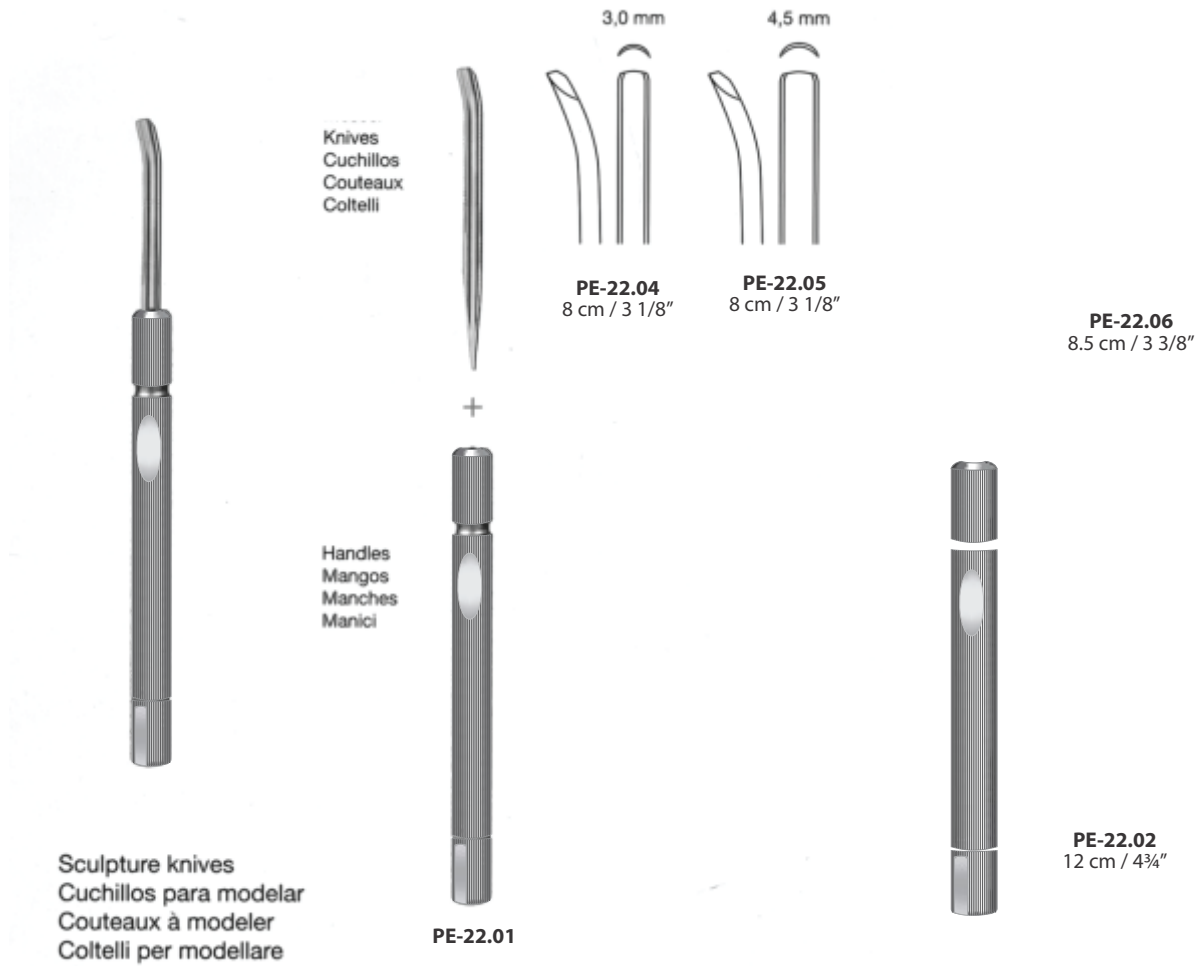

Dermatomes

Dermatomos

Dermatomes

Dermatomi



HUMBY
PE-30.30
32 cm / 12½"



PE-30.31
15.5 cm / 6 1/8"
spare blade



WATSON
PE-30.32
30.5 cm / 12"



SCHINK
PE-30.50
30 cm / 11¾"



PE-30.51
10 cm / 4"
spare blade



SILVER
PE-30.60
19 cm / 7½"

The grooved roller bar oscillates from side to side as well as rotating. The graft thickness is controlled by rotating the adjuster nuts at the end of knife, this will move the roller bar up or down.



BRAITHWAITE
PE-30.40
30.5 cm / 12"

The grooved roller bar only oscillates from side to side. The adjustment for the thickness of the graft is the same as the Braithwaite



COBBETT
PE-30.45
30.5 cm / 12"



PE-30.52
13 x 7.5 cm
skin stretching plate

Dermatome	
Thickness of cut	width of cut
0.1 , 2.0 mm	40mm max



Forceps
Pinzas
Pinces
Pinze

Delicate Forceps,
Dressing and Tissue

Pinzas finas,
anatómicas y
quirúrgicas

Pinces délictes,
anatomiques et
chirurgicales

Pinze delicate,
anatomiche e
chirurgiche



PF-07.14
14.5 cm / 5¾"



ADSON
PF-15.12
12 cm / 4¾"



ADSON "TC"
PF-15.62
12 cm / 4¾"



ADSON "TC"
PF-15.65
15 cm / 6"



HUDSON-EWALD
PF-16.01
12 cm / 4¾"



HUDSON-EWALD
PF-16.05
12 cm / 4¾"



ADSON



PF-16.12
12 cm / 4¾"



PF-16.13
12 cm / 4¾"



ADSON
PF-16.15
15 cm / 6"

Delicate Forceps,
Dressing and Tissue

Pinzas finas,
anatómicas y
quirúrgicas

Pinces délictes,
anatomiques et
chirurgicales

Pinze delicate,
anatomiche e
chirurgiche



ADSON "TC"
PF-16.62
12 cm / 4¾"



ADSON "TC"
PF-16.65
15 cm / 6"



MICRO ADSON



PF-17.12
12 cm / 4¾"



PF-19.12
12 cm / 4¾"



MICRO ADSON



PF-18.15
15 cm / 6"



PF-20.15
15 cm / 6"



ADSON BROWN
12 cm / 4¾"



PF-21.12

Teeth



PF-21.13

Delicate Forceps,
Dressing and Tissue

Pinzas finas,
anatómicas y
quirúrgicas

Pinces délictes,
anatomiques et
chirurgicales

Pinze delicate,
anatomiche e
chirurgiche



ADSON BROWN
PF-22.72
12 cm / 4¾"



ADSON GRAEFE
PF-23.82
12 cm / 4¾"



SEMKEN



PF-30.12
12.5 cm / 5"



PF-31.22
12.5 cm / 5"



PF-30.15
15 cm / 6"



PF-31.25
15 cm / 6"



SEMKEN



PF-32.12
12.5 cm / 5"



PF-33.22
12.5 cm / 5"



PF-32.15
15 cm / 6"



PF-33.25
15 cm / 6"



SEMKEN
PF-34.32
12.5 cm / 5"



MCINDOE
PF-35.15
15 cm / 6"



Delicate Forceps,
Dressing and Tissue

Pinzas finas,
anatómicas y
quirúrgicas

Pinces délictes,
anatomiques et
chirurgicales

Pinze delicate,
anatomiche e
chirurgiche



GILLIES
PF-36.85
15 cm / 6"

WAUGH

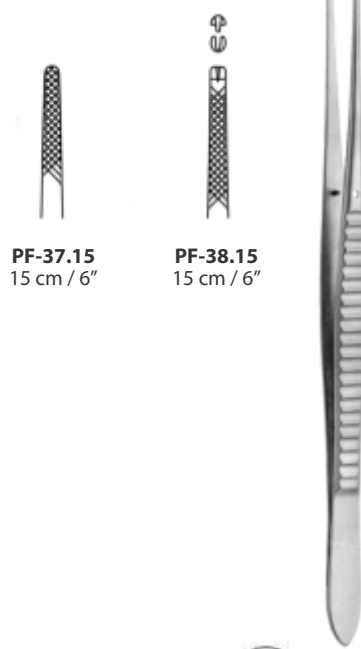

PF-37.15
15 cm / 6"

PF-38.15
15 cm / 6"

WAUGH

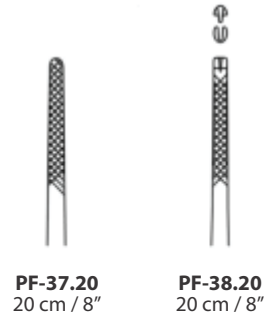

PF-37.20
20 cm / 8"

PF-38.20
20 cm / 8"



PF-42.40
20 cm / 8"



DEBAKEY "AT"
PF-43.15
15 cm / 6"

NELSON

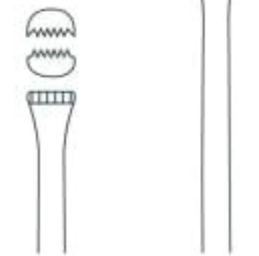

PF-60.15
15 cm / 6"

PF-60.23
23 cm / 9"



WALTER
PF-60.26
16 cm / 6¼"

WALTER
PF-60.36
16 cm / 6¼"

Delicate Forceps,
Dressing and Tissue

Pinzas finas,
anatómicas y
quirúrgicas

Pinces délictes,
anatomiques et
chirurgicales

Pinze delicate,
anatomiche e
chirurgiche

Bayonet Forceps



GRUENWALD
PF-64.16
16 cm / 6¼"



TROELTSCH (WILDE)
PF-70.13
13 cm / 5 1/8"

Suturing Forceps

Pinzas para sutura
Pinces à suture
Pinze per sutura



0.3 mm



PF-71.50
12 cm / 4¾"

0.3 mm



PF-71.51
12 cm / 4¾"

0.3 mm



PF-71.52
12 cm / 4¾"

0.3 mm



PF-71.53
12 cm / 4¾"

PF-71.60
15 cm / 6"

PF-71.61
15 cm / 6"

PF-71.62
15 cm / 6"

PF-71.63
15 cm / 6"

PF-71.70
18 cm / 7 1/8"

PF-71.71
18 cm / 7 1/8"

PF-71.72
18 cm / 7 1/8"

PF-71.73
18 cm / 7 1/8"



0.6 mm



PF-71.84
23 cm / 9"



Round Handle

Tissue Grasping Forceps

Pinzas para agarrar tejidos

Pinces à saisir les tissus

Pinze per afferrare tessuti

Lip Grasping Forceps



WALTER
PAB-57.18
8 cm / 3 1/8"



COTTLE
PAN-60.15
15 cm / 6"



FOX



PAN-62.13
13 cm / 5 1/8"



PAN-62.15
15 cm / 6"



with catch

FOX
PAN-64.15
15 cm / 6"

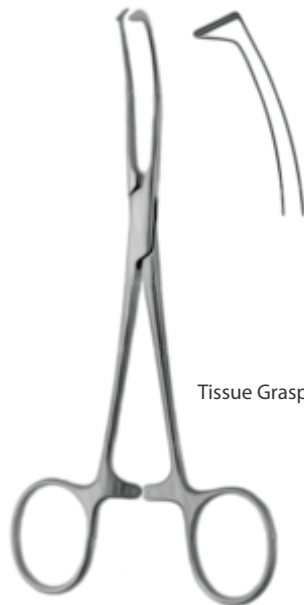

Tissue Grasping Forceps

FOX
PAN-65.15
15.5 cm / 6 1/8"



COTTLE
PAN-66.15
15 cm / 6"

Delicate Forceps,
Dressing and Tissue

Pinzas finas,
anatómicas y
quirúrgicas

Pinces délictes,
anatomiques et
chirurgicales

Pinze delicate,
anatomiche e
chirurgiche



Hemostatic Forceps
Pinzas hemostáticas
Pincès hémostatiques
Pinze emostatiche

Hemostatic Forceps

Pinzas hemostáticas

Pinces hémostatiques

Pinze emostatiche

50g Closing Pressure



DIETRICH



Bulldog Clamps



DIETRICH

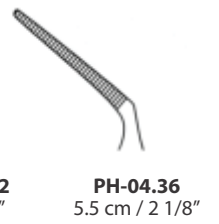
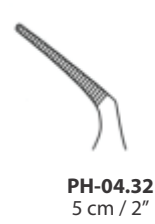

Halsted Mosquito

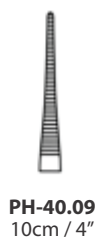

Micro MOSQUITO

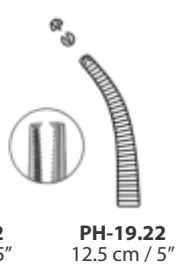
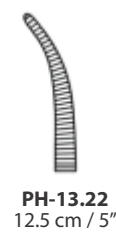
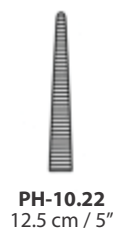

Hemostatic Forceps

Pinzas hemostáticas

Pinces hémostatiques

Pinze emostatiche

Atraumatic Serration



MOSQUITO "AT"



PH-14.42
12.5 cm / 5"



PH-15.42
12.5 cm / 5"



Micro Jacobson



PH-18.42
12.5 cm / 5"



PH-19.42
12.5 cm / 5"



MICRO JACOBSON
(KOSHIMA)



PH-18.52
12.5 cm / 5"



PH-19.52
12.5 cm / 5"



HALSTED MOSQUITO



PH-18.60
10 cm / 4"



PH-19.60
10 cm / 4"



PH-18.62
12.5 cm / 5"



PH-19.62
12.5 cm / 5"



Micro Jacobson

Hemostatic Forceps

Pinzas hemostáticas

Pinces hémostatiques

Pinze emostatiche

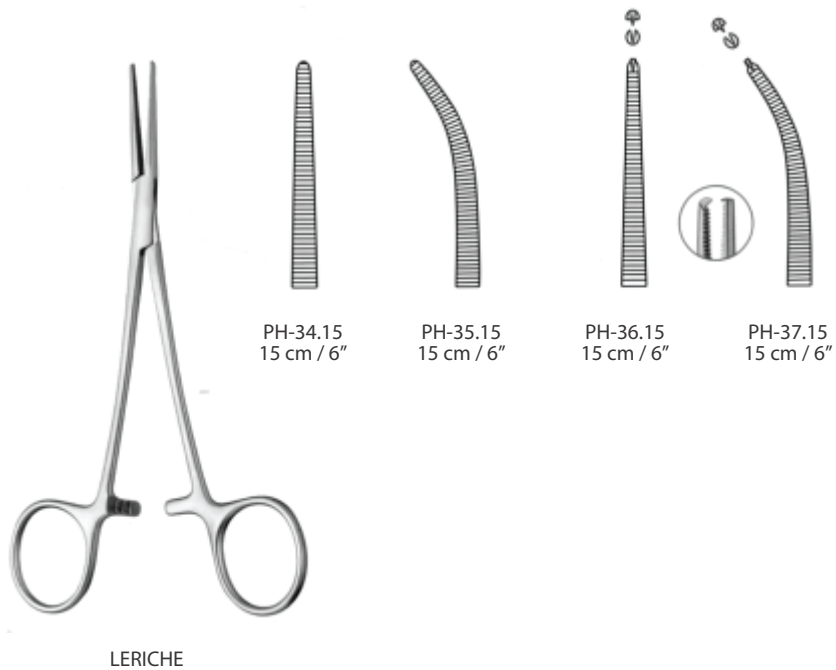
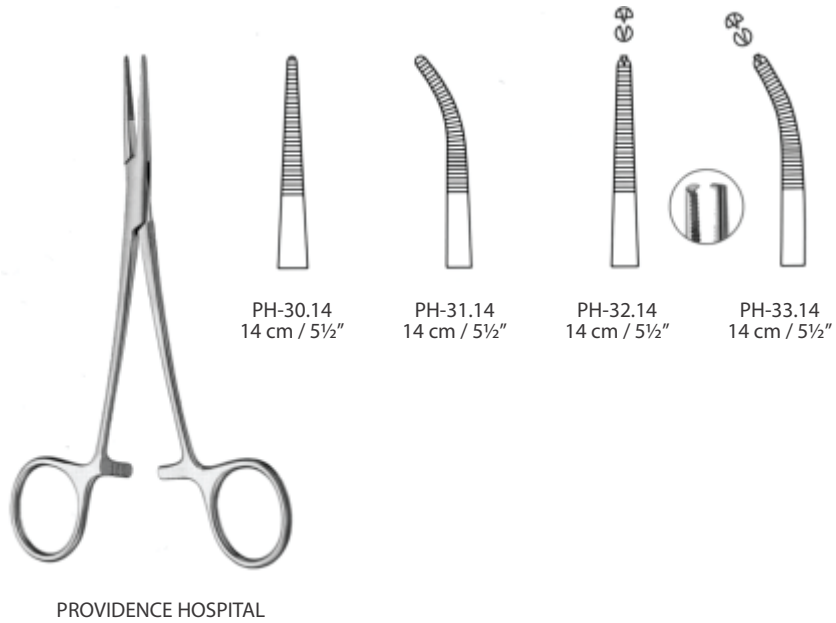



Needle Holders
Porta-agujas
Porte-aiguilles
Portaghi

Needle Holders

Porta-agujas

Porte-aiguilles

Portaghi



COLLIER
PJ-05.13
13 cm / 5 1/8"

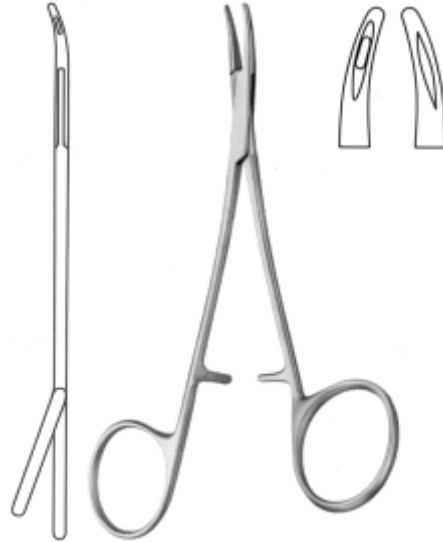

CONVERSE
PJ-06.15
15 cm / 6"



CONVERSE "TC"
PJ-07.65
15 cm / 6"



PJ-08.61
11.5 cm / 4 1/2"



PJ-08.63
13 cm / 5 1/8"



NEIVERT
PJ-09.12
12.5 cm / 5"



NEIVERT "TC"
PJ-10.62
12.5 cm / 5"

Needle Holders

Porta-agujas

Porte-aiguilles

Portaghi



WRIGHT (DERF)
PJ-12.12
12.5 cm / 5"



"TC"
PJ-13.61
12.5 cm / 5"



WRIGHT (DERF) "TC"
PJ-13.62
12.5 cm / 5"



HALSEY
PJ-14.13
13.5 cm / 5 3/8"



HALSEY "TC"
PJ-15.63
13.5 cm / 5 3/8"



DERF CONVERSE
PJ-17.82
12.5 cm / 5"

Needle Holders

Porta-agujas

Porte-aiguilles

Portaghi



CRILE WOOD



PJ-34.15
15 cm / 6"



PJ-21.18
18 cm / 7 1/8"



PJ-21.20
20 cm / 8"



PJ-21.23
23 cm / 9"



CRILE WOOD "TC"
(Debaquey)



PJ-22.15
15 cm / 6"



PJ-22.18
18 cm / 7 1/8"



PJ-22.20
20 cm / 8"



PJ-22.23
23 cm / 9"



PJ-22.25
25 cm / 10"



PJ-22.30
30 cm / 11 3/4"

Needle Holders

Porta-agujas

Porte-aiguilles

Portaghi



MAYO HEGAR



PJ-23.15
15 cm / 6"



PJ-23.18
18 cm / 7 1/8"



PJ-23.20
20 cm / 8"



PJ-23.23
23 cm / 9"



PJ-23.24
24 cm / 9 1/2"



MAYO HEGAR "TC"



PJ-24.15
15 cm / 6"



PJ-24.18
18 cm / 7 1/8"



PJ-24.20
20 cm / 8"



PJ-24.23
23 cm / 9"



PJ-24.24
24 cm / 9 1/2"



PJ-24.26
26 cm / 10 1/4"



PJ-24.30
30 cm / 11 3/4"

Needle Holders

Porta-agujas

Porte-aiguilles

Portaghi

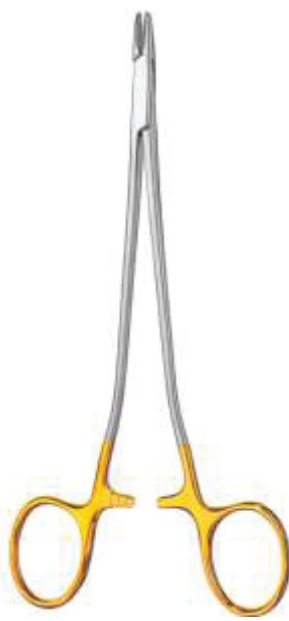

SENNING "TC"



PJ-45.15
15 cm / 6"



PJ-45.17
17 cm / 6¾"



PJ-45.16
15 cm / 6"



PJ-45.18
17 cm / 6¾"

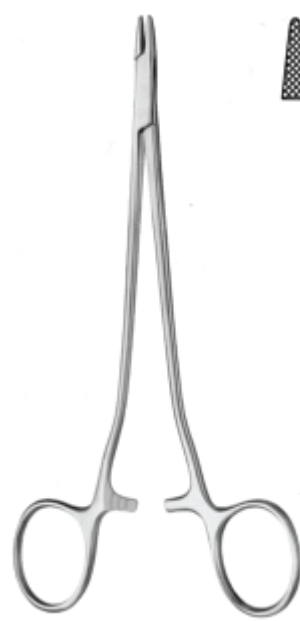

SENNING
PJ-46.17
17 cm / 6¾"

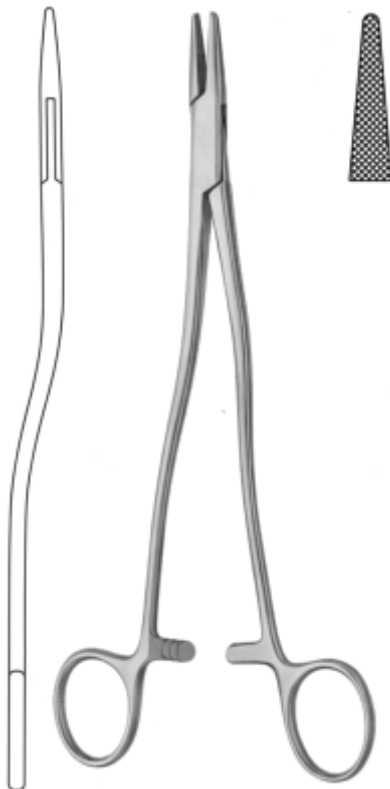

THOMSON WALKER
(BOZEMANN)
PJ-47.20
20 cm / 8"

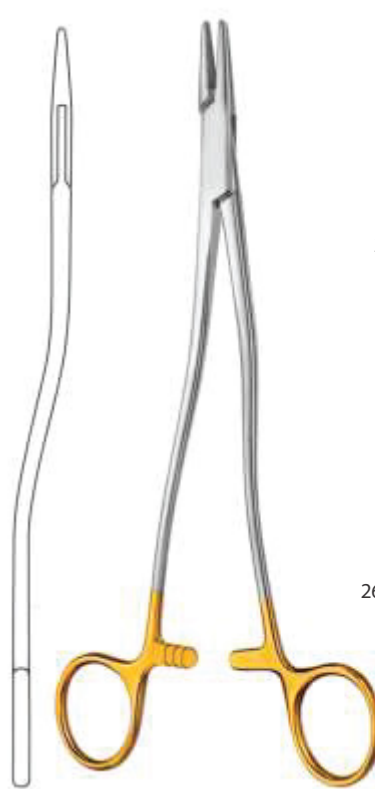

BOZEMANN "TC"
(WERTHEIM)



PJ-48.20
20 cm / 8"



PJ-48.24
24 cm / 9½"



PJ-48.26
26 cm / 10¼"



PJ-48.30
30 cm / 11¾"

Needle Holders

Porta-agujas

Porte-aiguilles

Portaghi



GILLIES SLIM
PJ-53.14
14.5 cm / 5¾"



GILLIES SLIM "TC"
PJ-54.15
14.5 cm / 5¾"

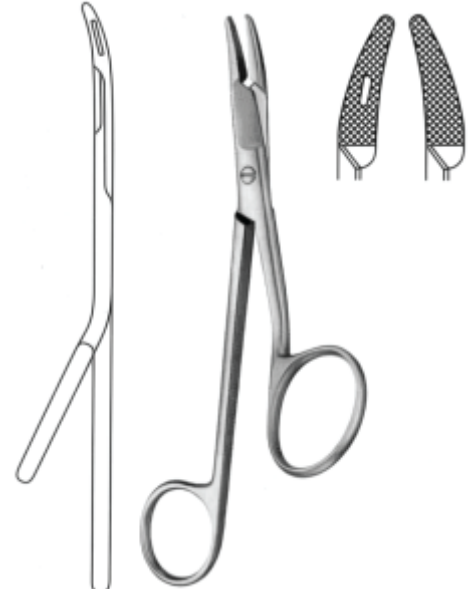

GILLIES
PJ-55.15
15.5 cm / 6 1/8"

Needle holder with scissors

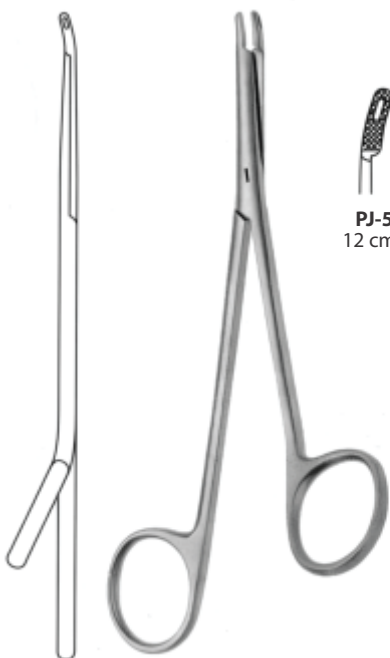

OBWEGESER GILLIES

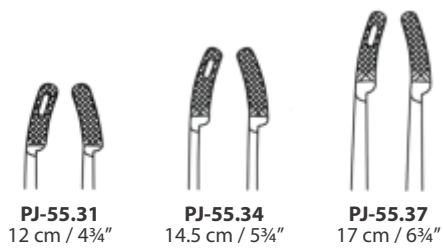

PJ-55.31
12 cm / 4¾"

PJ-55.34
14.5 cm / 5¾"

PJ-55.37
17 cm / 6¾"

with scissors

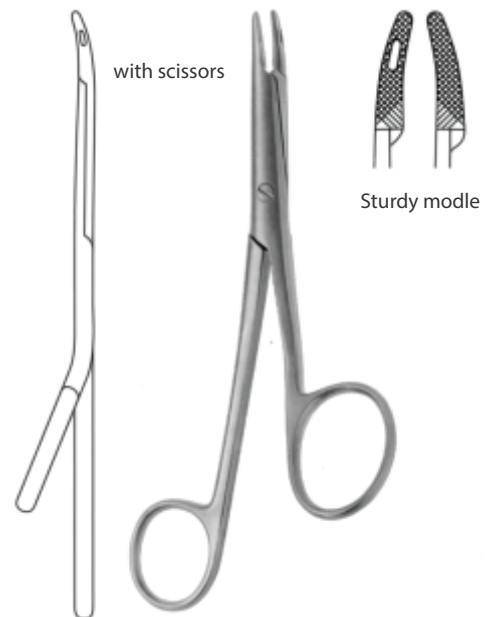

OBWEGESER GILLIES
PJ-55.58
16 cm / 6¼"

Needle Holders

Porta-agujas

Porte-aiguilles

Portaghi



GILLIES "TC"
PJ-56.16
15.5 cm / 6 1/8"

MATHIEU "TC"

PJ-69.14
14 cm / 5 1/2"

PJ-69.17
17 cm / 6 3/4"

PJ-69.20
20 cm / 8"

PJ-69.24
24 cm / 9 1/2"

Mucosa Needle Holder



COTTLE MASING



PAN-30.56
a = 60 mm



PAN-30.59
a = 90 mm



smooth jaws

Micro Needle Holders

Micro porta-agujas

Micro porte-aiguilles

Micro portaghi



<p>a = 0.4 mm a = 0.4 mm</p>	<p>13 cm / 5 1/8" PK-22.13</p>	<p>15 cm / 6" PK-21.15 PK-22.15</p>	<p>18 cm / 7 1/8" PK-21.18 PK-22.18</p>	<p>21 cm / 9" PK-21.21 PK-22.21</p>
<p>a = 0.5 mm a = 0.5 mm</p>	<p>13 cm / 5 1/8" PK-24.13</p>	<p>15 cm / 6" PK-23.15 PK-24.15</p>	<p>18 cm / 7 1/8" PK-23.18 PK-24.18</p>	<p>21 cm / 9" PK-23.21 PK-24.21</p>
<p>a = 0.4 mm a = 0.4 mm</p>	<p>13 cm / 5 1/8" PK-24.13</p>	<p>15 cm / 6" PK-23.15 PK-24.15</p>	<p>18 cm / 7 1/8" PK-23.18 PK-24.18</p>	<p>21 cm / 9" PK-23.21 PK-24.21</p>
<p>a = 0.5 mm a = 0.5 mm</p>	<p>13 cm / 5 1/8" PK-24.33</p>	<p>15 cm / 6" PK-23.38 PK-24.38</p>	<p>18 cm / 7 1/8" PK-23.38 PK-24.38</p>	<p>21 cm / 9" PK-23.41 PK-24.41</p>



<p>a = 0.4 mm a = 0.4 mm</p>	<p>13 cm / 5 1/8" PK-32.13</p>	<p>15 cm / 6" PK-31.15 PK-32.15</p>	<p>18 cm / 7 1/8" PK-31.18 PK-32.18</p>	<p>21 cm / 9" PK-31.21 PK-32.21</p>
<p>a = 0.5 mm a = 0.5 mm</p>	<p>13 cm / 5 1/8" PK-32.13</p>	<p>15 cm / 6" PK-31.38 PK-32.38</p>	<p>18 cm / 7 1/8" PK-31.38 PK-32.38</p>	<p>21 cm / 9" PK-31.41 PK-32.41</p>
<p>a = 0.4 mm a = 0.4 mm</p>	<p>13 cm / 5 1/8" PK-34.13</p>	<p>15 cm / 6" PK-33.15 PK-34.15</p>	<p>18 cm / 7 1/8" PK-33.18 PK-34.18</p>	<p>21 cm / 9" PK-33.21 PK-34.21</p>
<p>a = 0.5 mm a = 0.5 mm</p>	<p>13 cm / 5 1/8" PK-34.33</p>	<p>15 cm / 6" PK-33.38 PK-34.38</p>	<p>18 cm / 7 1/8" PK-33.38 PK-34.38</p>	<p>21 cm / 9" PK-33.41 PK-34.41</p>

Needle Holders

Porta-agujas

Porte-aiguilles

Portaghi



Wires and Wire Instruments

Alambre y Instrumentos para alambre
Fils et instruments pour fils métalliques
Fili e strumenti per fili d'acciaio

Elevators
Elevadores
Elévateurs
Elevatori

Mallets
Martillos
Maillets
Martelli

Mallets

Martillos

Maillets

Martelli

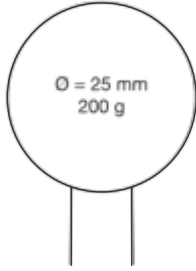

with plastic facings
(unscrewable)

PM-08.18
18.5 cm / 7¼"



FWLER
PM-07.25
Aluminium Handle
10 oz

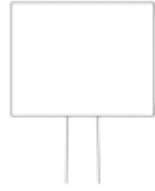

COTTE
PM-08.40
19 cm / 7½"

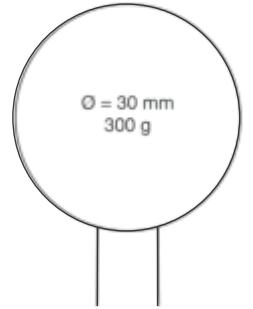

The round face is used
for cartilage crusher

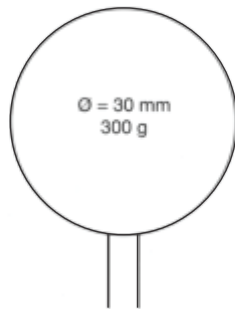

with inclined facings

GUILLEN
PM-08.75
24 cm / 9½"

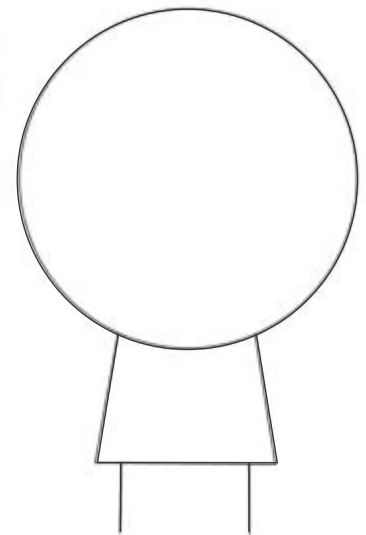

26 cm / 10¼"

Ø = 35 mm, 150 g **PM-14.35**
Ø = 45 mm, 240 g **PM-14.45**
Ø = 50 mm, 330 g **PM-14.50**

made of NOVOTEX Plastic
(autoclaveable up to 134° cat 3 bar)

Elevators

Elevadores

Elévateurs

Elevatori

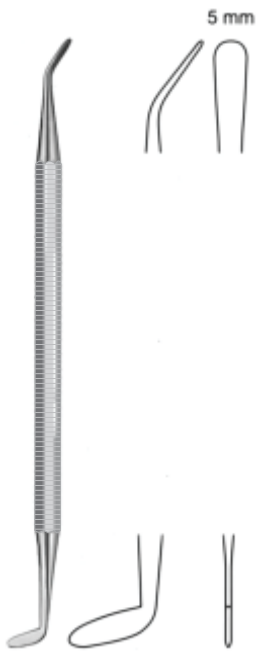

PT-11.26
16 cm / 6¼"

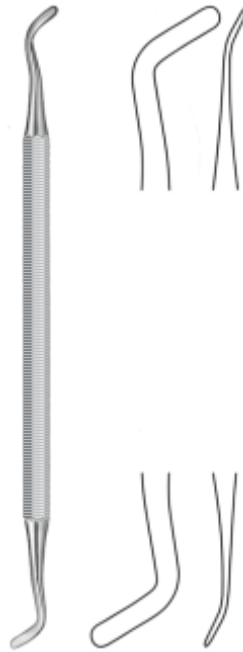

PT-11.27
17 cm / 6¾"



LANGENBECK
PT-13.04
23 cm / 9"



WILLIGER
16 cm / 6¼"



PT-15.03



PT-15.05



PT-15.07

Preparation of the access for the lateral osteotomy



MCKENTY
15 cm / 6"



PT-17.04



PT-17.05

Dissection of the meatus inferior



FREER
PT-18.01
19 cm / 7½"



5 mm

Elevators
Raspatories

Elevadores
Legras

Elévateurs
Rugines

Elevatori
Periostomi

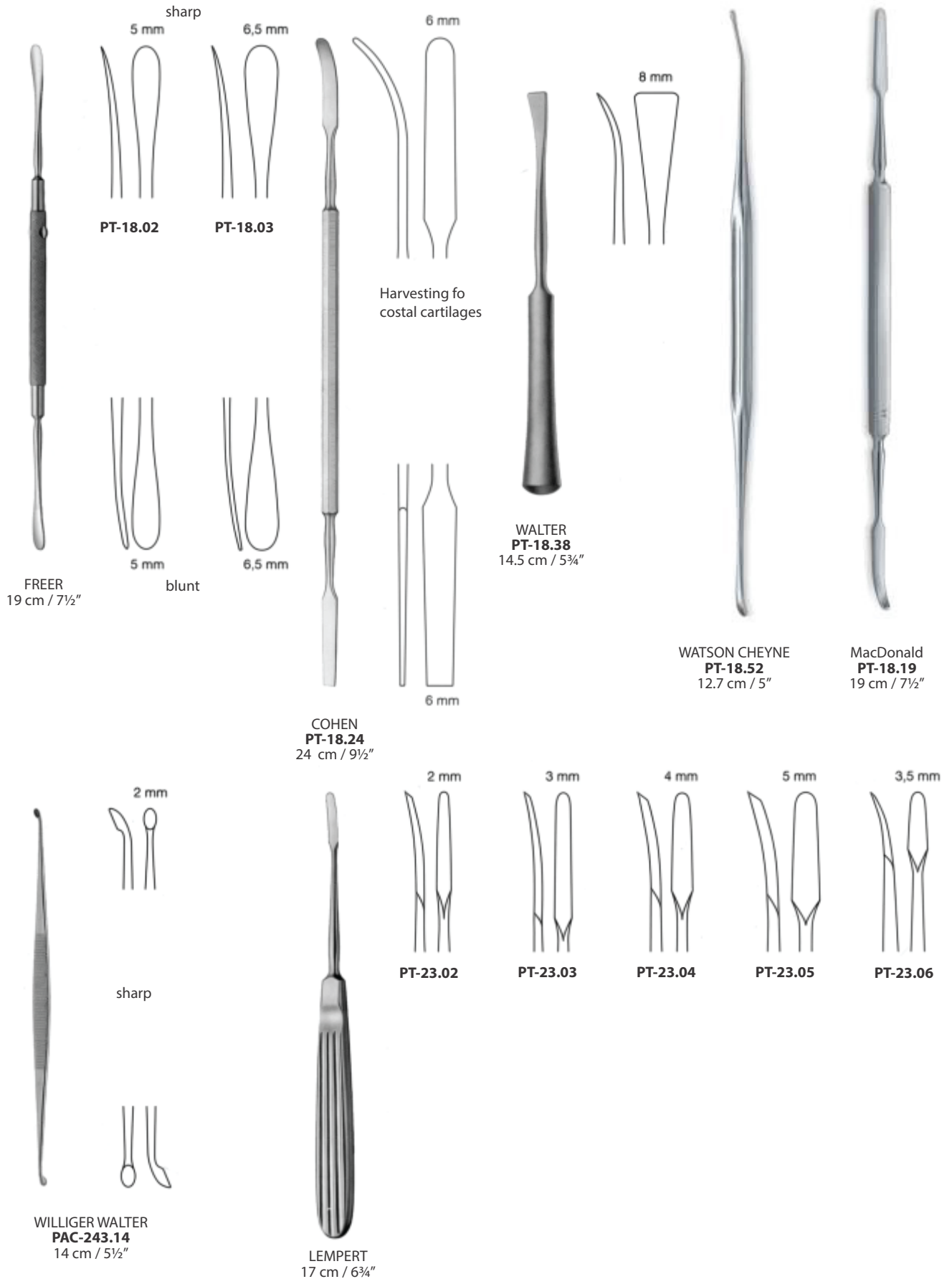

Raspatories

Legras

Rugines

Periostotomi

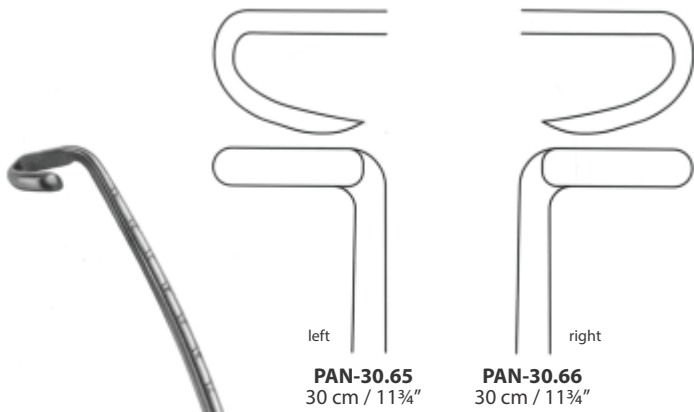

Rib Raspatories



OBWEGESER

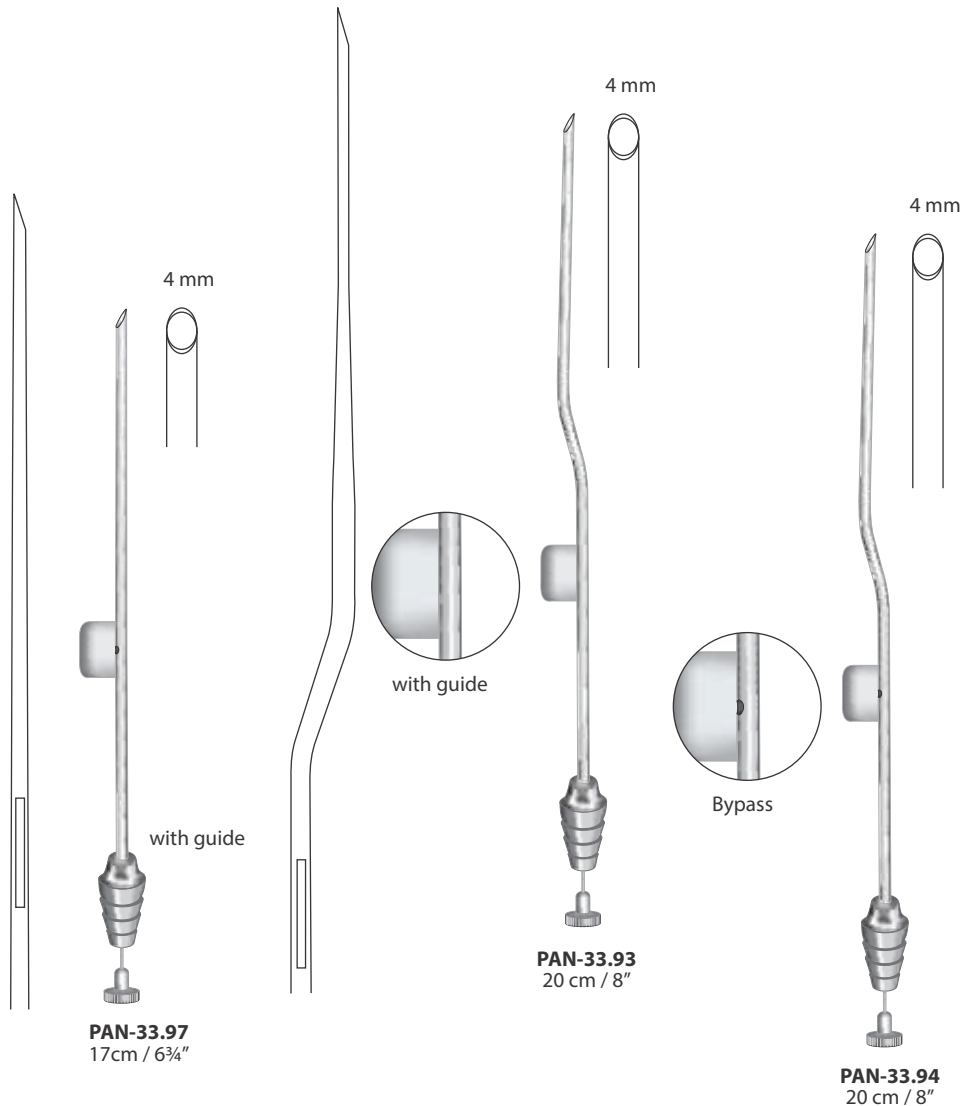

Raspatories

Legras

Rugines

Periostotomi



COTTLE
PAN-31.19
18 cm / 7 1/8"



COTTLE
PAN-31.20
18 cm / 7 1/8"

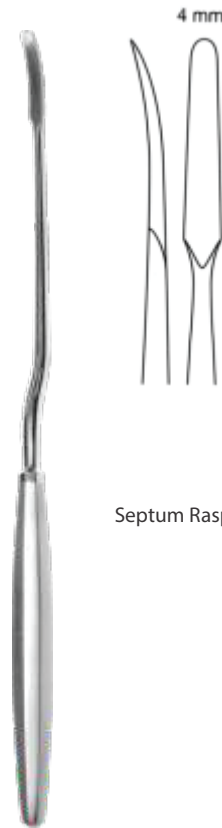

JOSEPH MASING
PAN-31.48
22 cm / 8 3/4"

Septum Raspatory



YANKAUER
PAN-31.55
18 cm / 7 1/8"

Septum Elevator

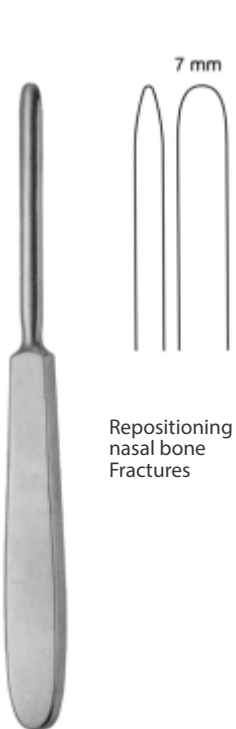

PAN-31.60
17 cm / 6 3/4"

Repositioning of
nasal bone
Fractures



CONVERSE
PAN-31.65
18 cm / 7 1/8"

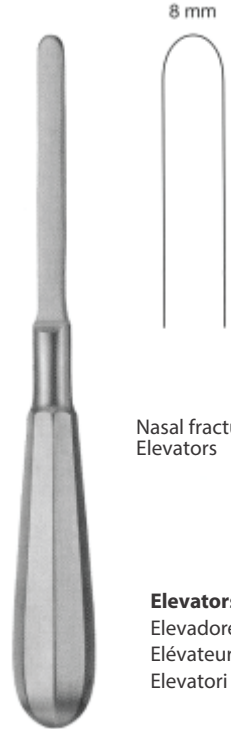

BOIES
PAN-31.69
19 cm / 7 1/2"

Nasal fracture
Elevators

Elevators
Elevadores
Elévateurs
Elevatori

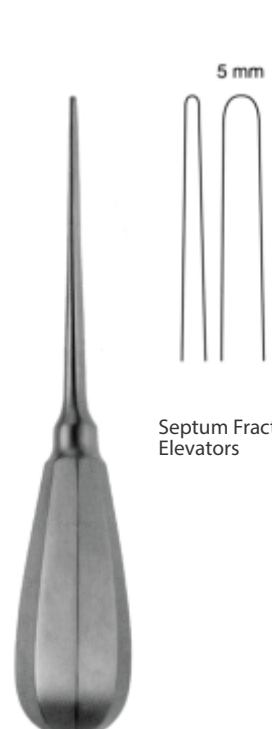

GOLDMAN
PAN-31.75
17 cm / 6 3/4"

Septum Fracture
Elevators

Elevators

Elevadores

Elévateurs

Elevatori

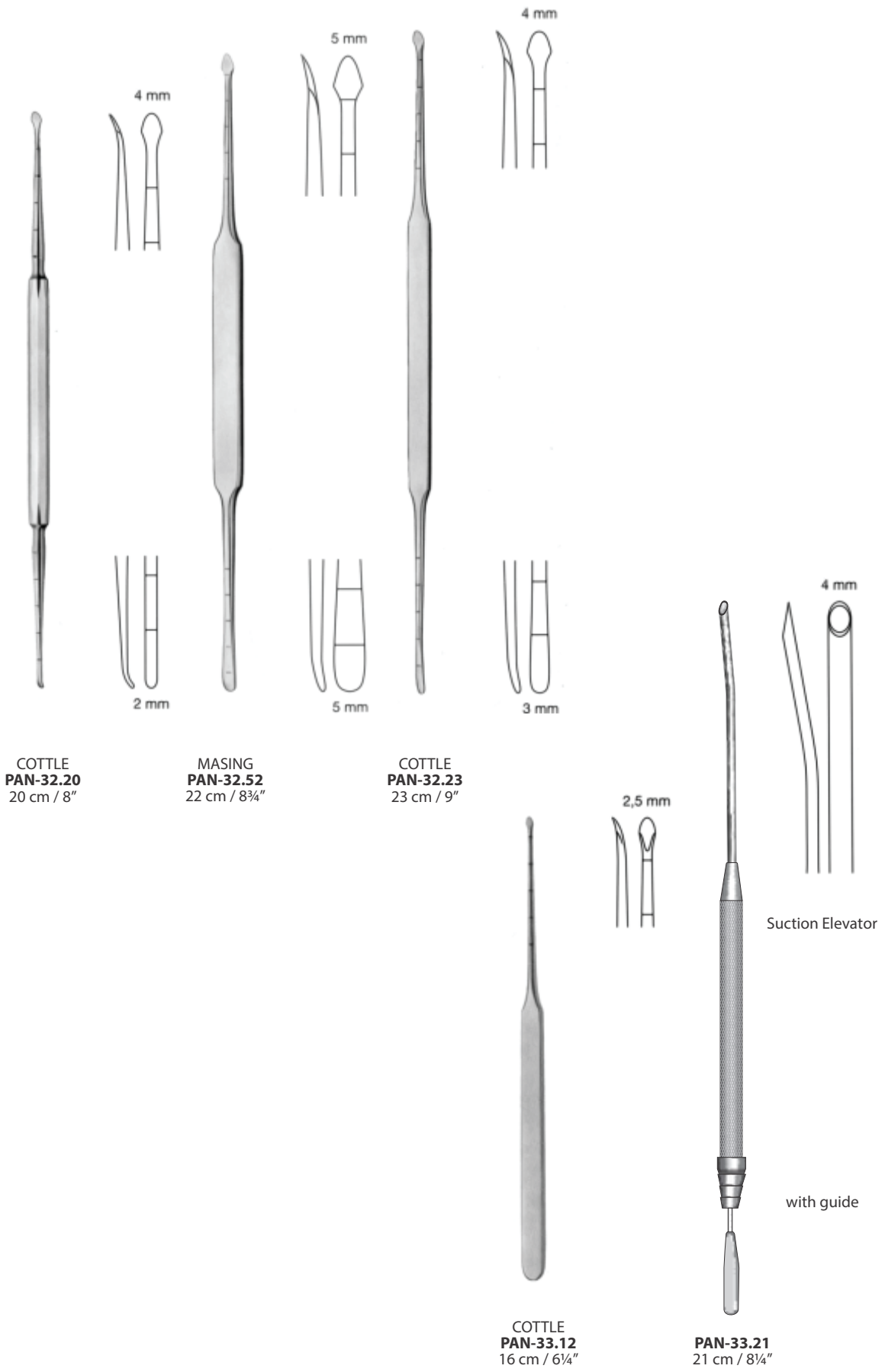

Raspatories

Legras

Rugines

Periostotomi

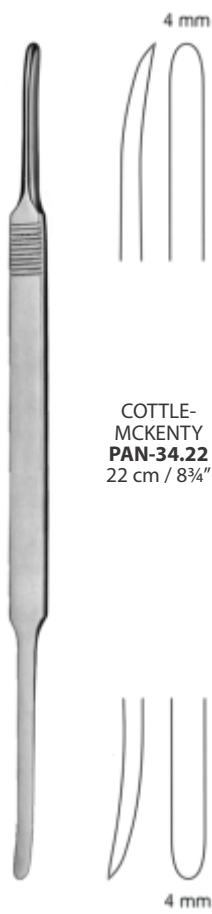

Raspatories

Legras

Rugines

Periostotomi



HARGIS
PAN-36.35
19 cm / 7½"



OBWEGESER
18 cm / 7 1/8"

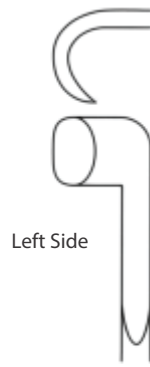

Left Side

PAN-36.36



Rigth Side

PAN-36.37



OBWEGESER
PAN-36.38
17.5 cm / 7"



9 mm



OBWEGESER
17.5 cm / 7"



7 mm

PAN-36.39



11 mm

PAN-36.40



OBWEGESER
20 cm / 8"

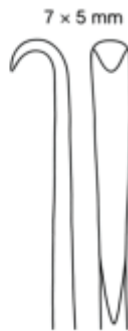

7 x 5 mm

PAN-36.41



10 x 7 mm

PAN-36.42



11 x 9 mm

PAN-36.43



BRAITHWAITE
14.5cm/ 5¾"
PAN-37.44 without guard
PAN-37.45 guard on left
PAN-37.46 guard on right

Raspatories

Legras

Rugines

Periostotomi

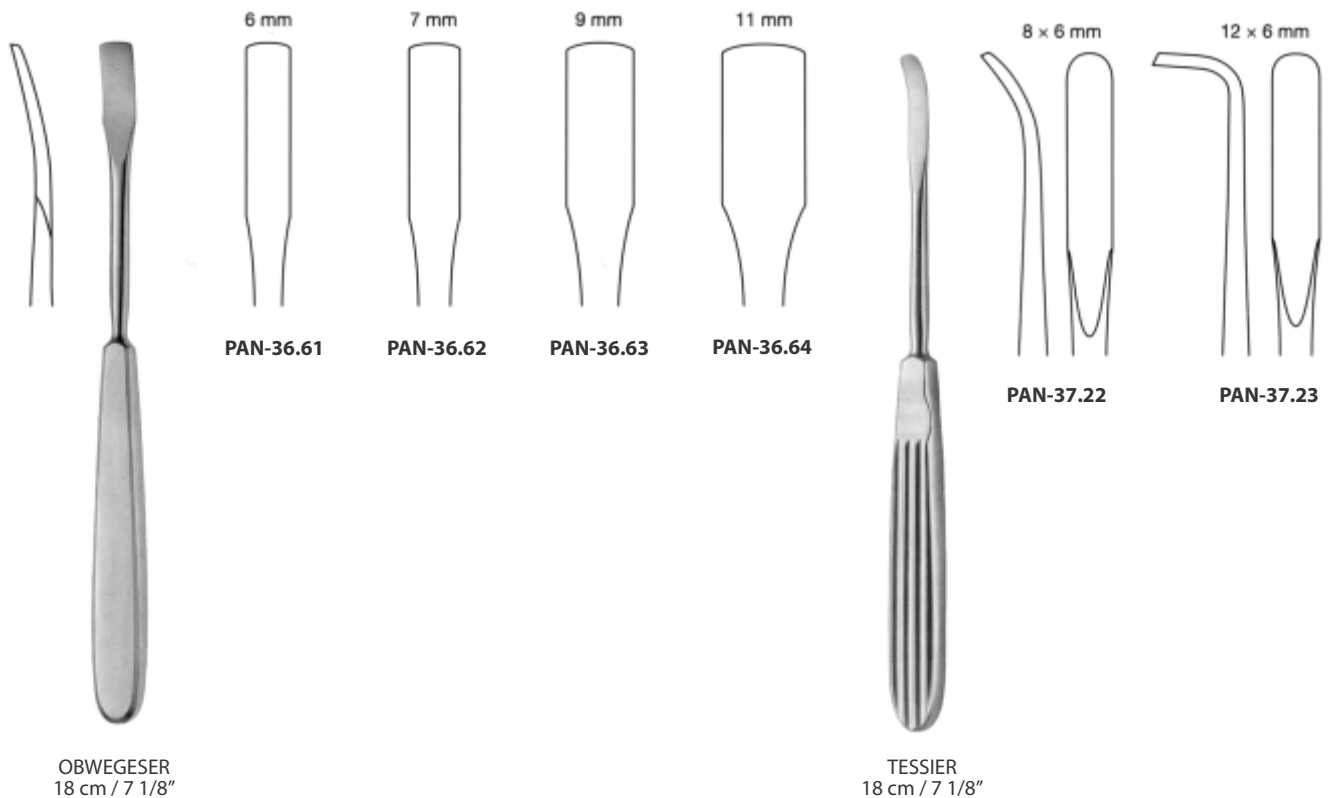
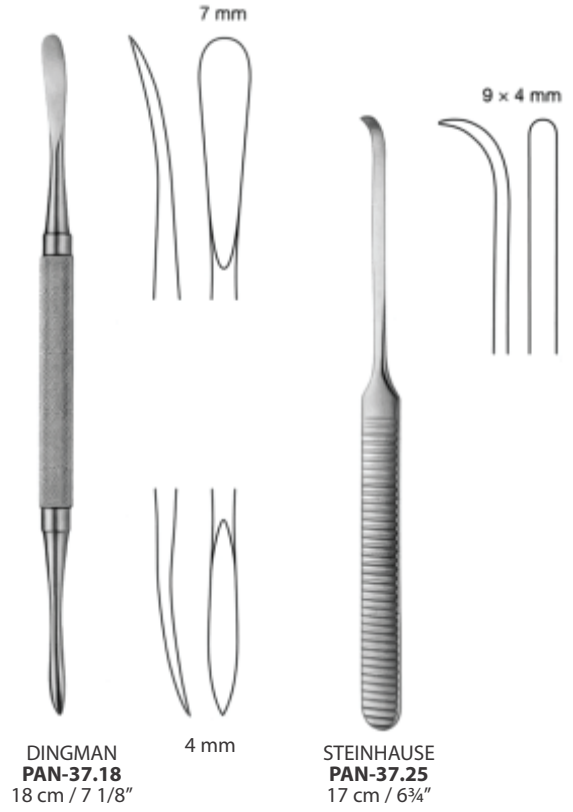
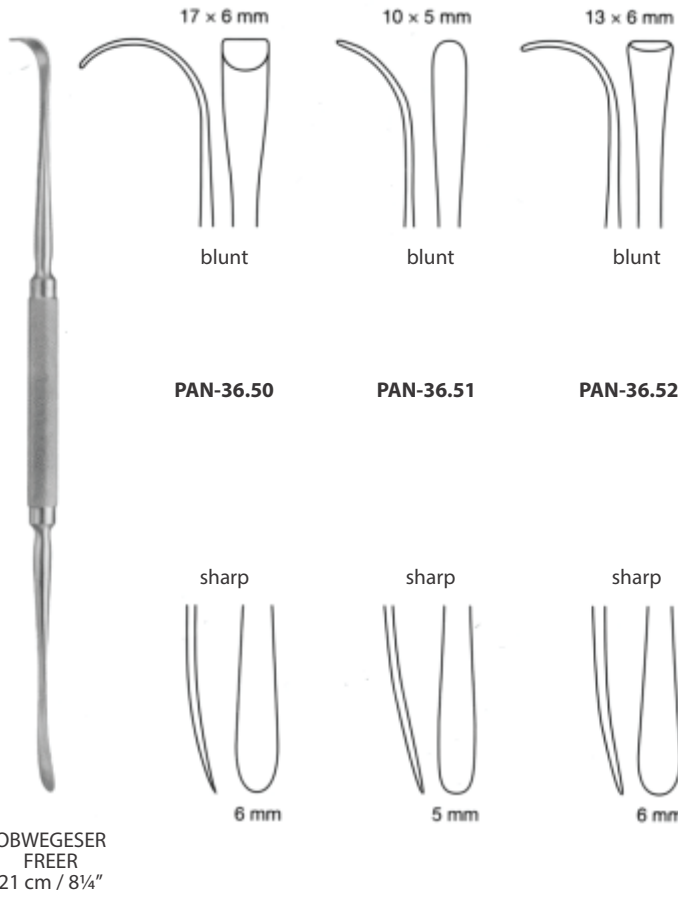

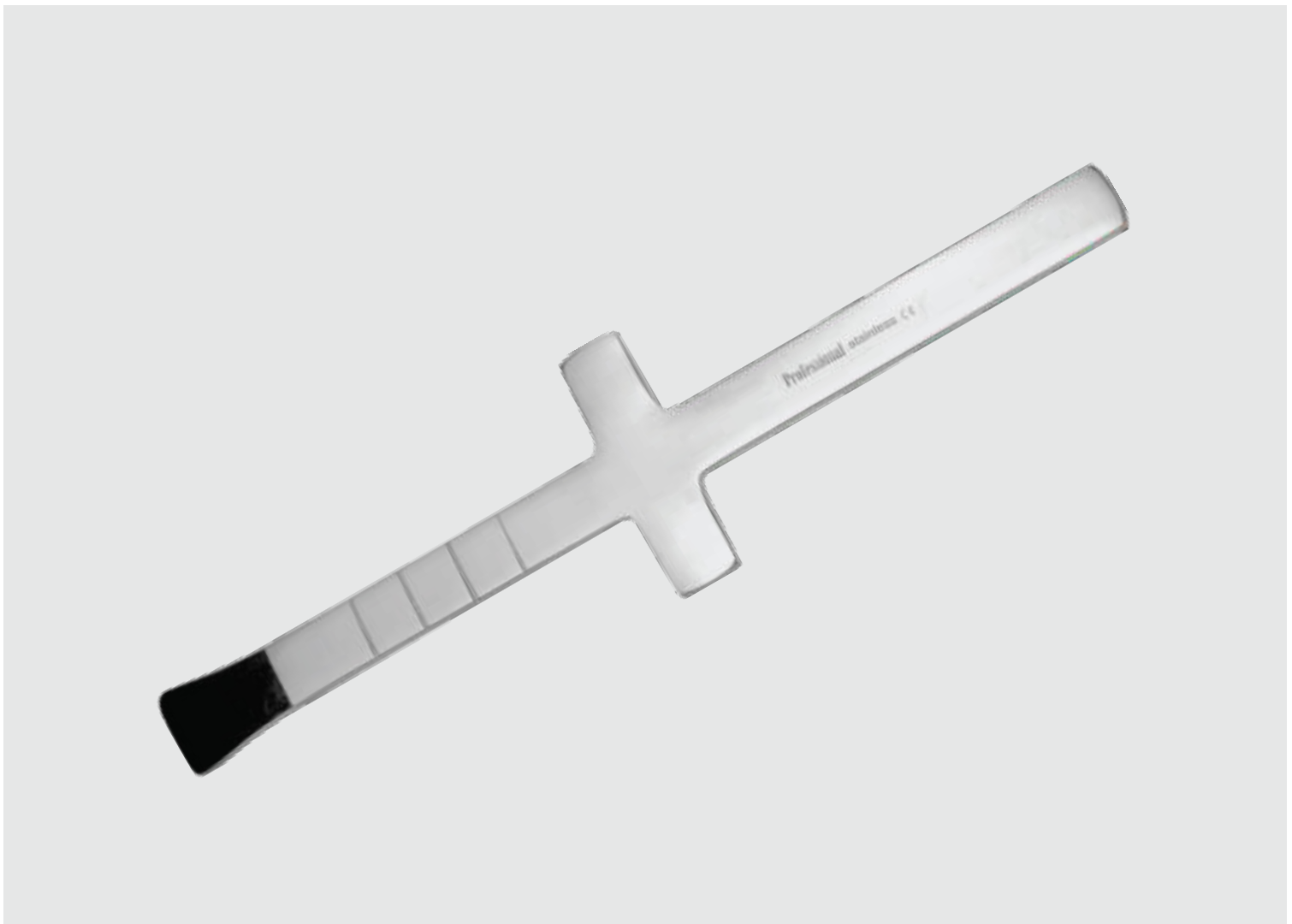

Chisels
Cinceles
Gouges
Sgorbie

Elevators
Elevadores
Elévateurs
Elevatori

Elevators
Chisels

Elevadores
Cinceles

Elévateurs
Gouges

Elevatori
Sgorbie

Mucosa knife

Cuchillo para mucosa
Septotome
Cotello per mucosa



FREER "D"
PAM-20.16
16 cm / 6¼"



BALLENGER
16 cm / 6¼"

4 mm



PAM-24.16

6 mm



PAM-24.17



FREER
15.5 cm / 6 1/8"

4 mm



PAM-25.16

6 mm



PAM-25.17



KILLIAN
PAM-25.46
17.5 cm / 7"

6 mm



Septum Gouges



KILLIAN CLAU
PAM-25.47
17 cm / 7"

6 mm



HOWARTH
PAM-30.40
21.5 cm / 8½"



PENNINGTON
PAM-30.50
20 cm / 8"



Chisels

Cinceles

Gouges

Sgorbie

5 mm
12 mm
PAN-27.55
PAN-27.62

Hollow cut
Hohlschliff
Vaciado hueco

Graduated
Graduiert
Graduada

COTTLE
18 cm / 7 1/8"

4 mm
PAN-28.04

7 mm
PAN-28.07

9 mm
PAN-28.09

12 mm
PAN-28.12

Graduated
Graduiert
Graduada

COTTLE
18 cm / 7 1/8"

6 mm

for transversal osteotomy
für transversale Osteotomie
para osteotomía transversal

Graduated
Graduiert
Graduada

COTTLE
PAN-28.16
18 cm / 7 1/4"

16 mm

Fishtail
Fischschwanz
Cola de pez

Graduated
Graduiert
Graduada

COTTLE
PAN-28.20
18 cm / 7 1/8"

4 mm
PAN-28.24

7 mm
PAN-28.27

9 mm
PAN-28.29

12 mm
PAN-28.32

Graduated
Graduiert
Graduada

COTTLE
18 cm / 7 1/8"

16 mm

Fishtail
Fischschwanz
Cola de pez

Graduated
Graduiert
Graduada

COTTLE
PAN-28.38
18 cm / 7 1/8"

Osteotomes

osteotomes

ostéotomes

osteotomi

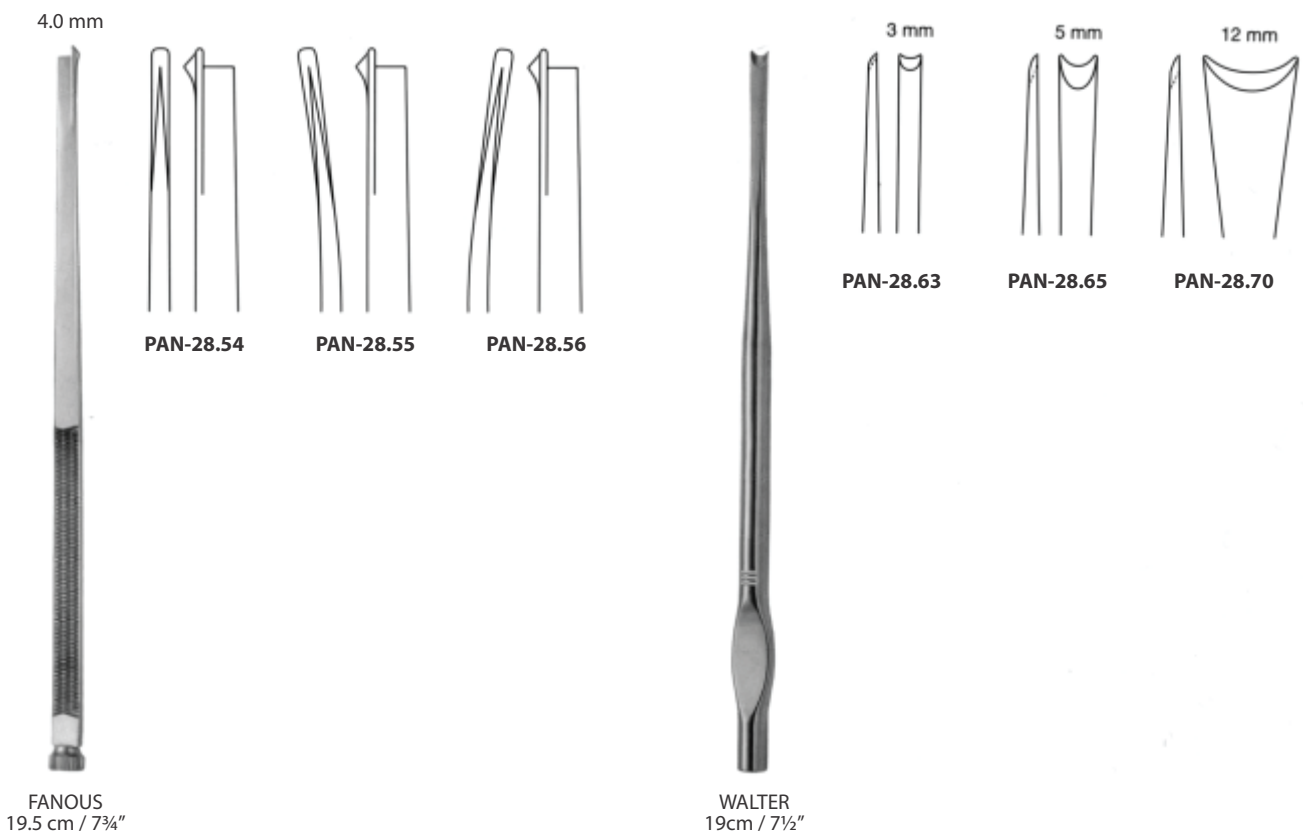
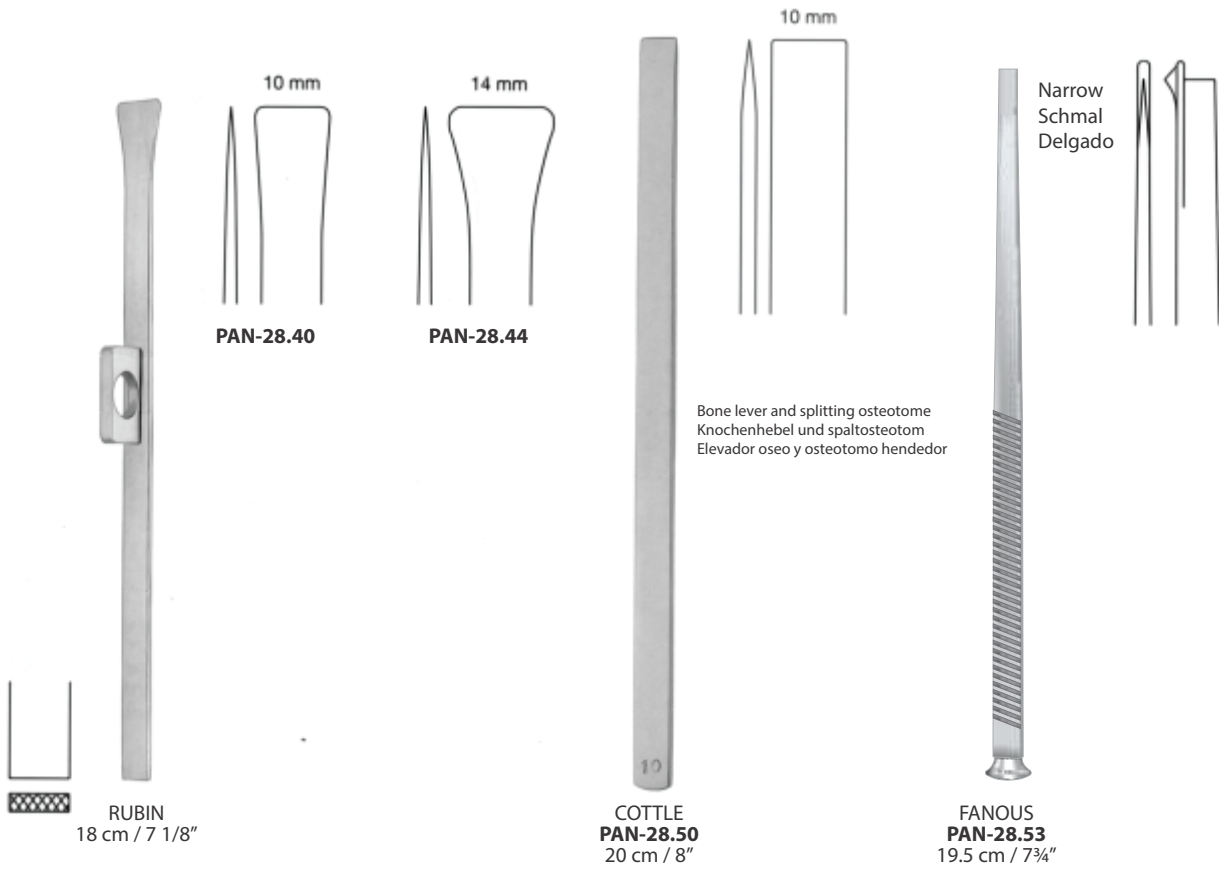

Chisels

Cinceles

Gouges

Sgorbie

Osteotome
Osteotomes
Osteotomos

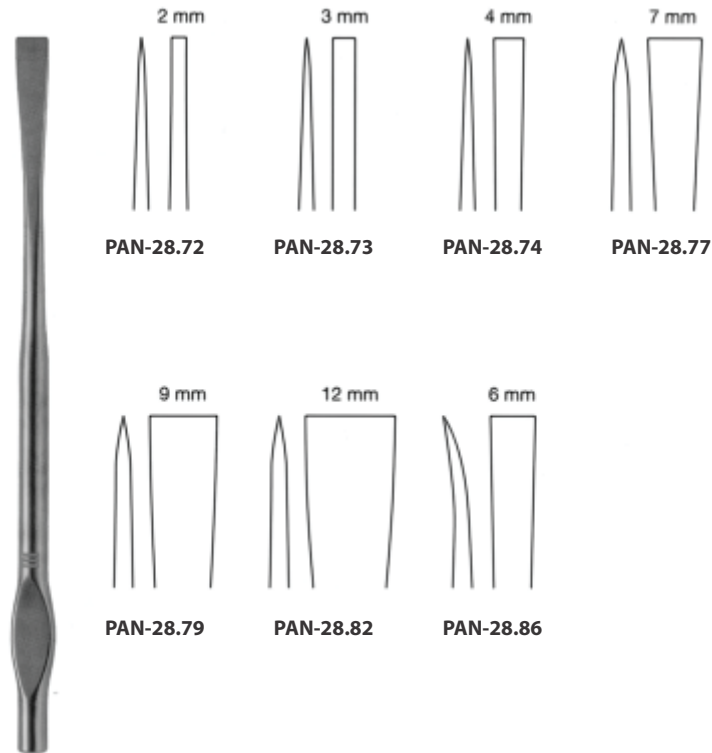

2 mm
PAN-28.72

3 mm
PAN-28.73

4 mm
PAN-28.74

7 mm
PAN-28.77

9 mm
PAN-28.79

12 mm
PAN-28.82

6 mm
PAN-28.86

WALTER
19cm / 7½"

- . The surgeon orientates the position of the chisel through the lateral guiding thron
- . Minimal traumatisation
- . Preferred application for lateral osteotomy with enoral and endonasal access
- . Der operateur orientiert sich mittels des lateralen fuhrungs-dorns uber die meibelposition
- . Minimale Traumatisierung
- . Bevorzugte anwendung fur die laterale osteotomie bei enoralem und endonasalem zugang
- . El cirujano se orienta mediante la espina guia lateral para determinar la posicion del cincel
- . Traumatzacion minima
- . Aplicacion preferida para la osteotomia lateral con acceso intraoral intranasal

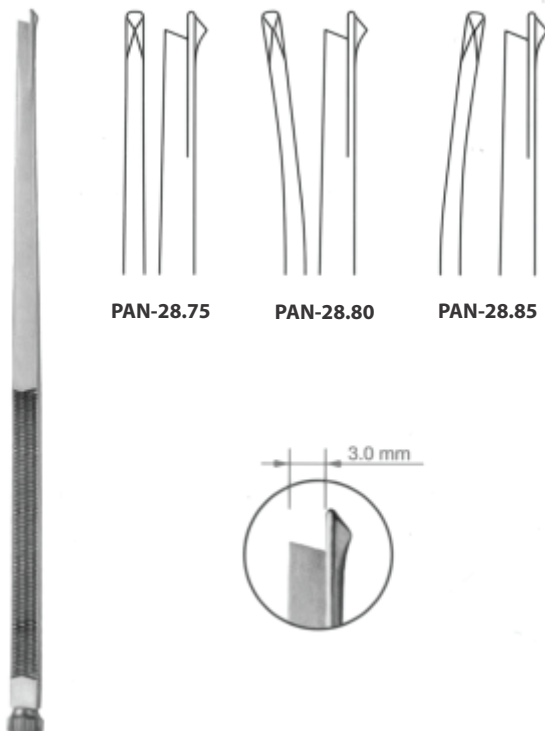

PAN-28.75

PAN-28.80

PAN-28.85

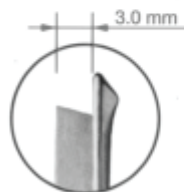

SCHROM
19.5 cm / 7¾"

Chisels and Osteotomes

Cinceles y osteotomos

Gouges et ostéotomes

Sgorbie e osteotomi

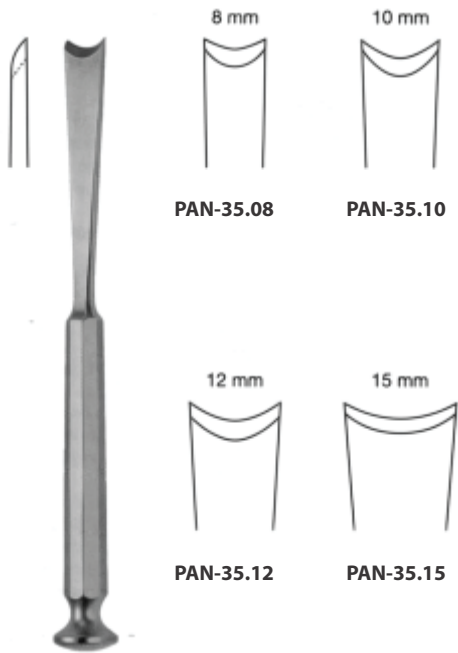

MCINDOE
16 cm / 6 1/4"

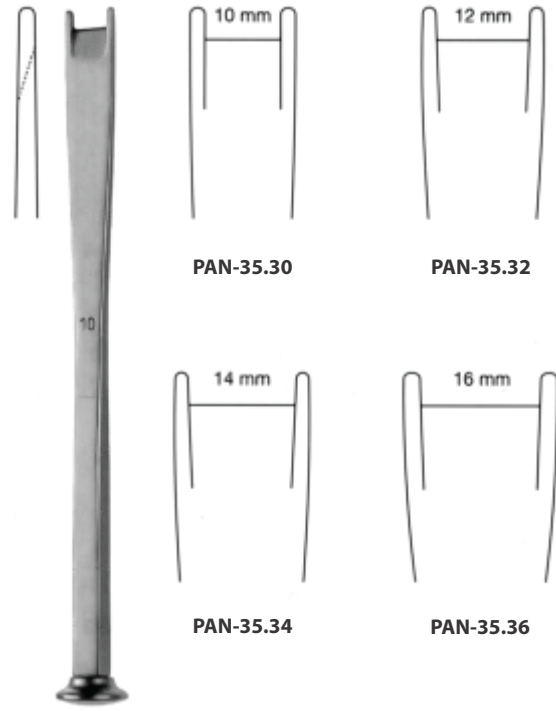

MOBERG
18 cm / 7 1/8"

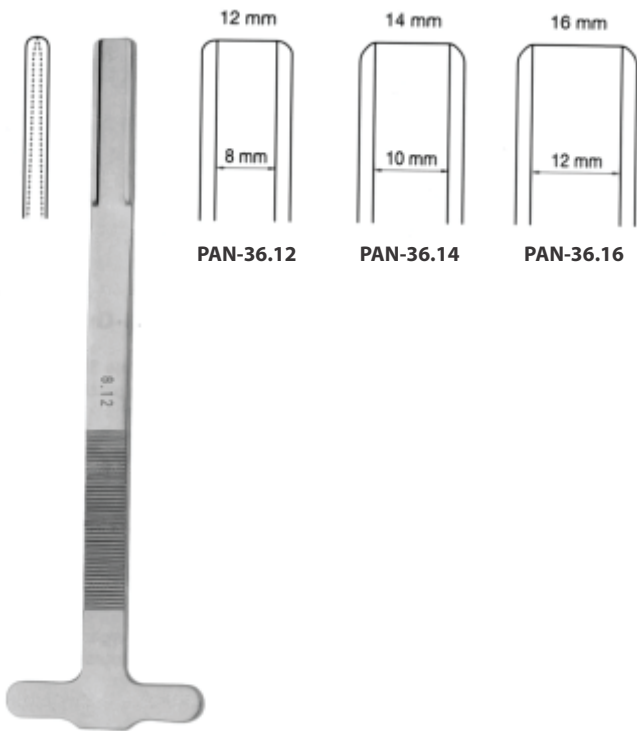

RUBIN
18 cm / 7 1/8"

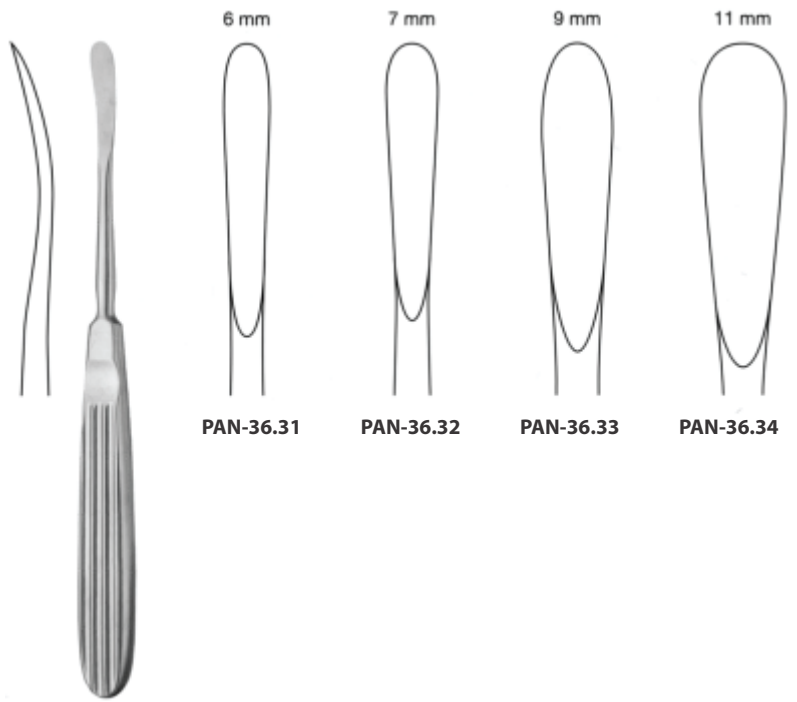

OBWEGESER
17.5 cm / 7"

Raspatories

Legras

Rugines

Periostotomi



HARGIS
PAN-36.35
19 cm / 7½"



OBWEGESER
18 cm / 7 1/8"

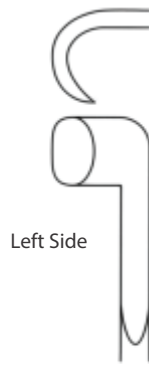

Left Side

PAN-36.36



Rigth Side

PAN-36.37



OBWEGESER
PAN-36.38
17.5 cm / 7"



OBWEGESER
17.5 cm / 7"



PAN-36.39



PAN-36.40



OBWEGESER
20 cm / 8"

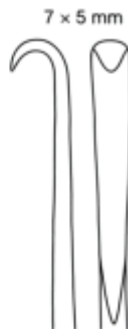

PAN-36.41



PAN-36.42



PAN-36.43



BRAITHWAITE
14.5cm/ 5¾"
PAN-37.44 without guard
PAN-37.45 guard on left
PAN-37.46 guard on right

Chisels



FOMON

Cinceles



PAN-38.17
17 cm / 6¾"



PAN-38.19
17 cm / 6¾"



PAN-38.20
17 cm / 6¾"

Gouges



SILVER
18 cm / 7 1/8"

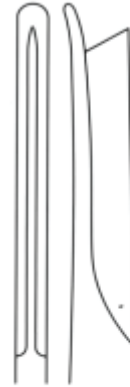

PAN-40.01

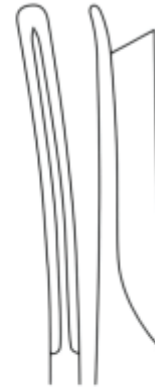

PAN-40.02



PAN-40.03



CINELLI
16 cm / 6¼"



PAN-39.10

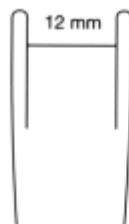

PAN-39.12

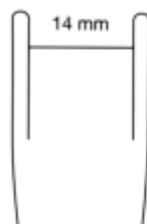

PAN-39.14



PAN-39.16



BLUME
PAN-40.20
18 cm / 7 1/8"



Chisels and Osteotomes

Cinceles y osteotomes

Gouges et ostéotomes

Sgorbie e osteotomi



Aluminium Handle

PAN-40.53
18.5 cm / 7¼"

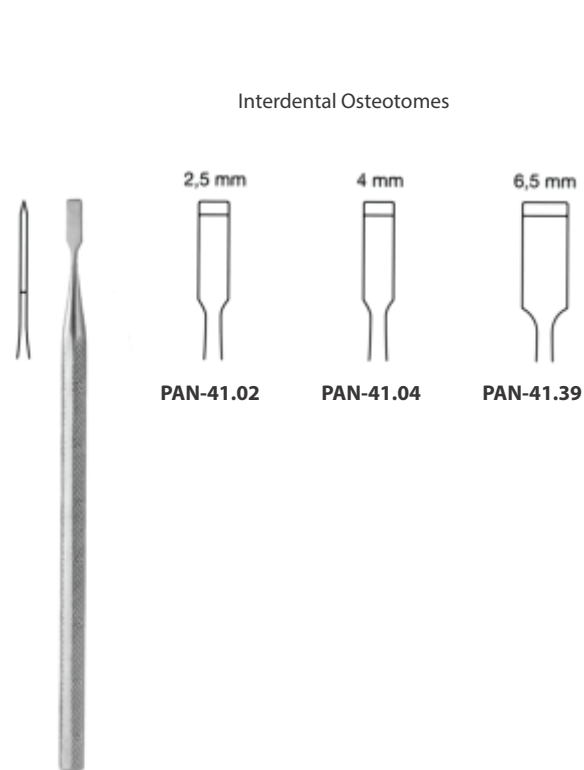

Interdental Osteotomes

2,5 mm **PAN-41.02**
4 mm **PAN-41.04**
6,5 mm **PAN-41.39**

OBWEGESER
15 cm / 6"

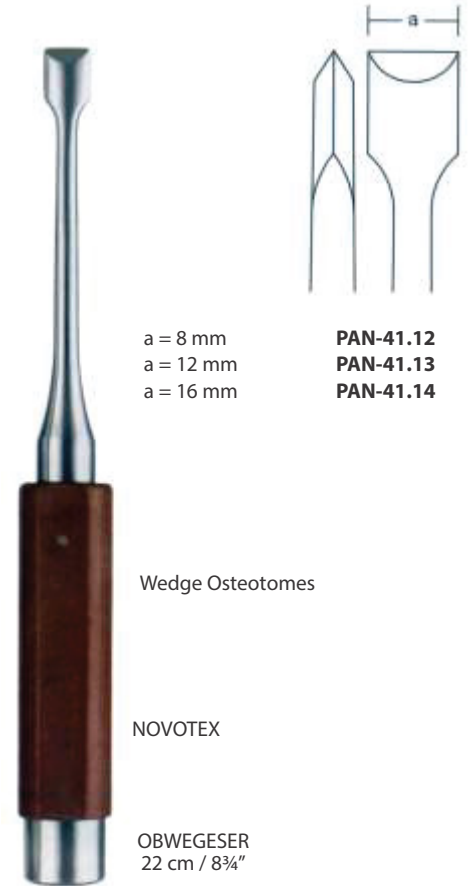

a = 8 mm
a = 12 mm
a = 16 mm

PAN-41.12
PAN-41.13
PAN-41.14

Wedge Osteotomes

NOVOTEX

OBWEGESER
22 cm / 8¾"

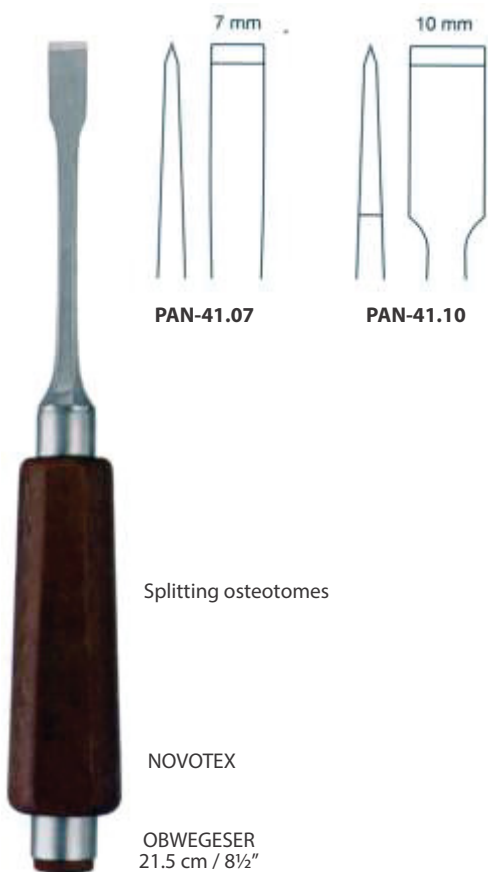

PAN-41.07

PAN-41.10

Splitting osteotomes

NOVOTEX

OBWEGESER
21.5 cm / 8½"

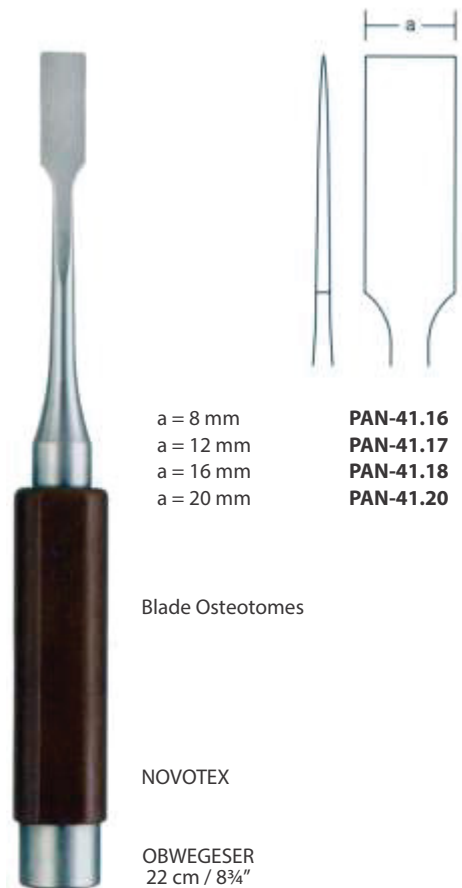

a = 8 mm
a = 12 mm
a = 16 mm
a = 20 mm

PAN-41.16
PAN-41.17
PAN-41.18
PAN-41.20

Blade Osteotomes

NOVOTEX

OBWEGESER
22 cm / 8¾"

Osteotomes

osteotomes

ostéotomes

osteotomi

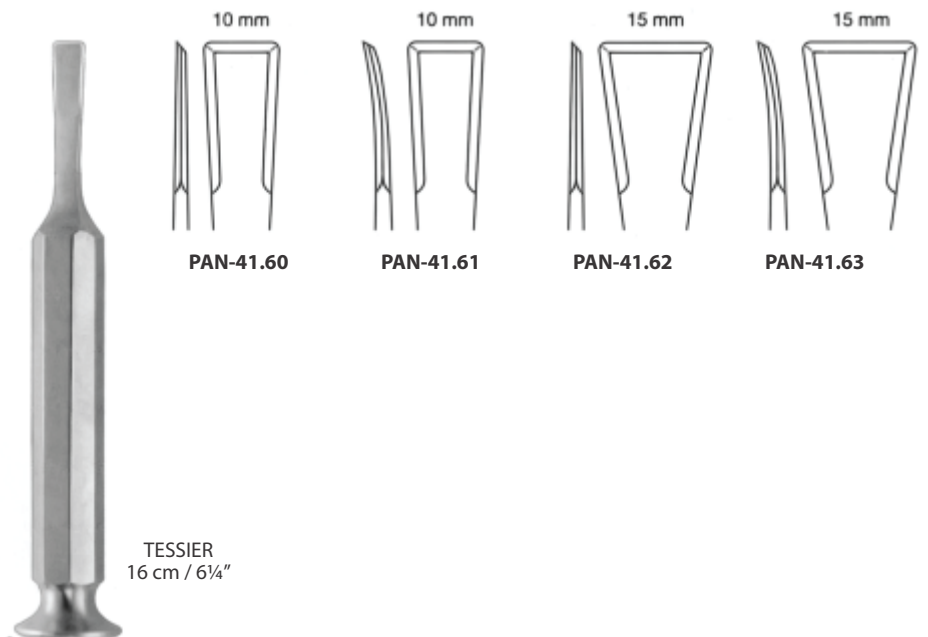
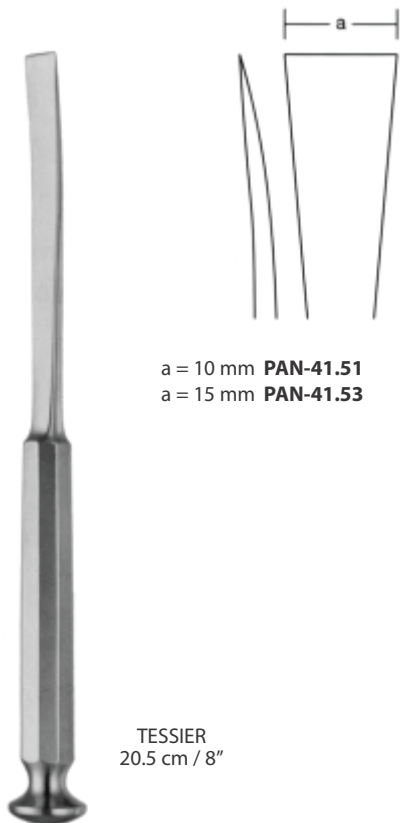
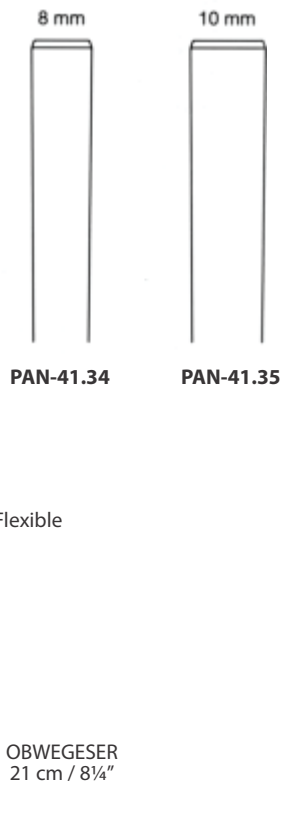
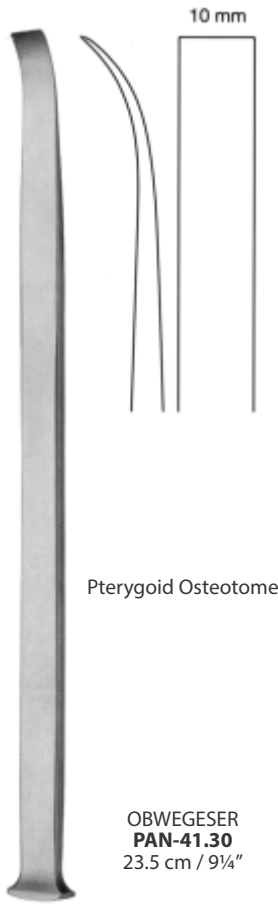

Osteotomes

osteotomes

ostéotomes

osteotomi

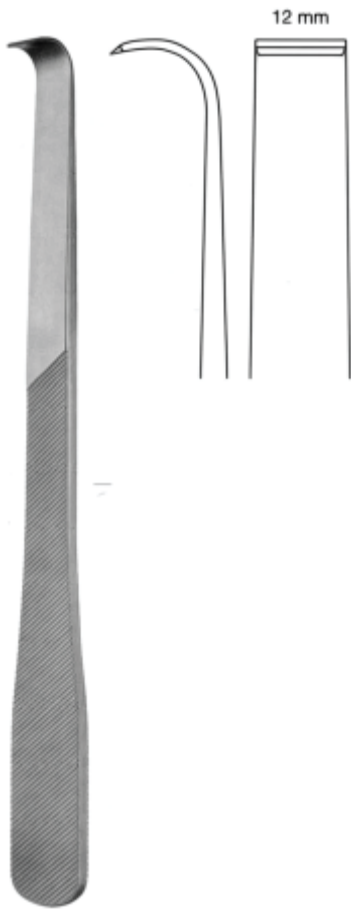

OBWEGESER
PAN-42.29
23 cm / 9"

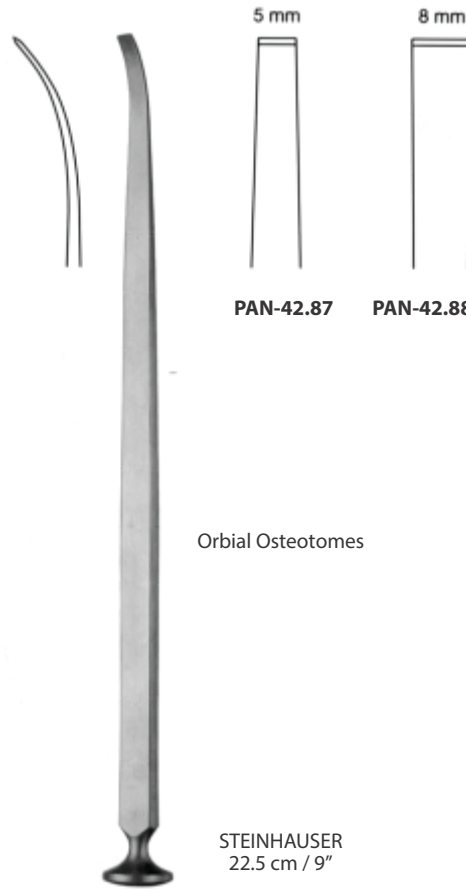

Orbital Osteotomes

STEINHAUSER
22.5 cm / 9"

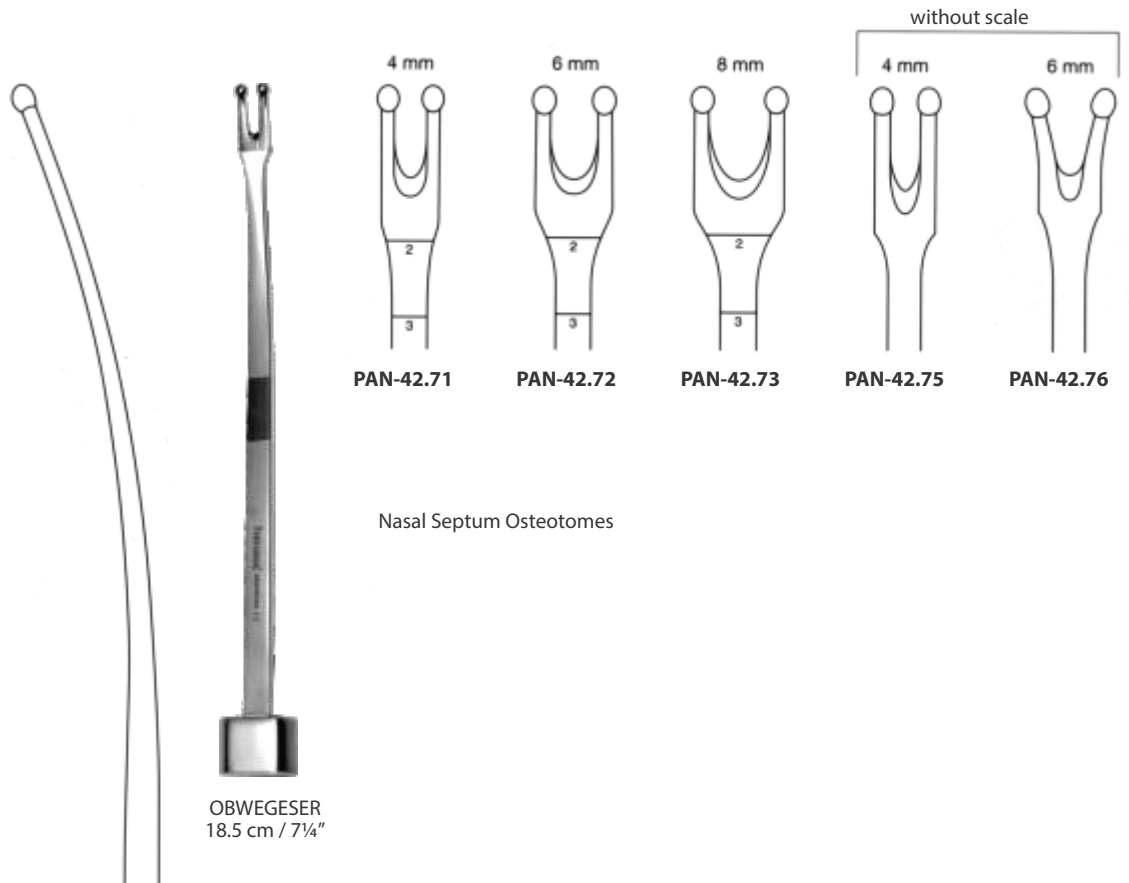

OBWEGESER
18.5 cm / 7 1/4"

Nasal Septum Osteotomes

Cylinder Osteotomes

Osteotomes cilíndricos

Ostéotomes cylindriques

Osteotomi cilindrici

Cortical Cutter

Ø 12 mm



SHEPARD
PAN-42.02
12 cm / 4¾"

Cross Pin



For turning cylinder osteotomes

SHEPARD
PAN-42.11
11 cm / 4 3/8"

cylinder osteotomes



Ø = 5 mm
Ø = 6 mm
Ø = 8 mm

SHEPARD



12.5 cm / 5"
PAN-42.05
PAN-42.06
PAN-42.08

Ram



14 cm / 5½"
PAN-42.12
PAN-42.13
PAN-42.14

Trocars



14.5 cm / 5¾"
PAN-42.15
PAN-42.16
PAN-42.18



Retactors
Separadores
Ecarteurs
Divaricatori

Delicate Retractors,
double-ended

Separadores fios,
dobles

Ecarteurs fins,
dobules

Divaricatori delicati,
doppi



SENN MILLER
(Insulated)



SENN MILLER



PY-01.16
PY-01.16 INS
16 cm / 6 1/4"
sharp



PY-02.16
PY-02.16 INS
16 cm / 6 1/4"
blunt



19 x 5,5 mm



RAGNELL
PY-05.16
16 cm / 6 1/4"

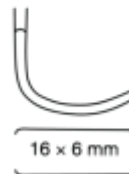

16 x 6 mm



COPE
PY-05.18
18 cm / 7 1/8"

10 x 13 mm

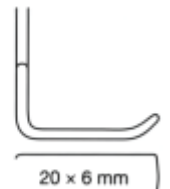

20 x 6 mm



KAWAMOTO
PAB-165.15 INS
15 cm / 6"
(Insulated)



COPE WALTER
PY-05.25
16 cm / 6 1/4"

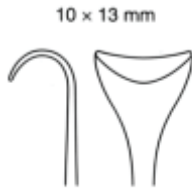

Nasal Retractor



20 x 6 mm



SENN GREEN



PY-07.50
14 cm / 5 1/2"

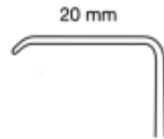

PY-07.52
14 cm / 5 1/2"

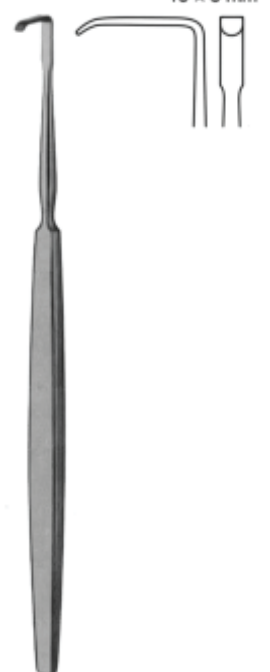

PY-07.58
18 cm / 7 1/8"

15 x 3 mm

Delicate Retactors

Separadores fios

Ecarteurs fins,

Divaricatori delicati

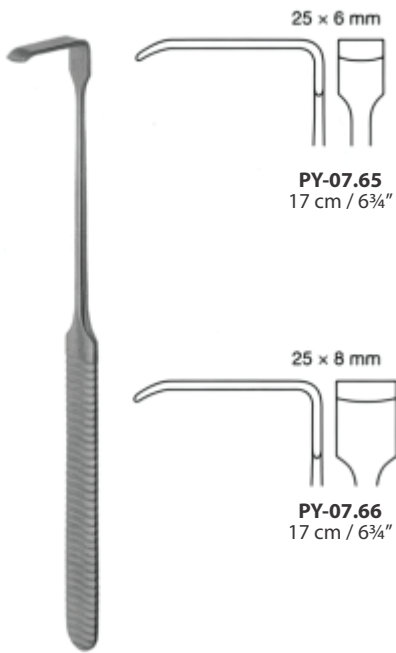

LANGENBECK GREEN

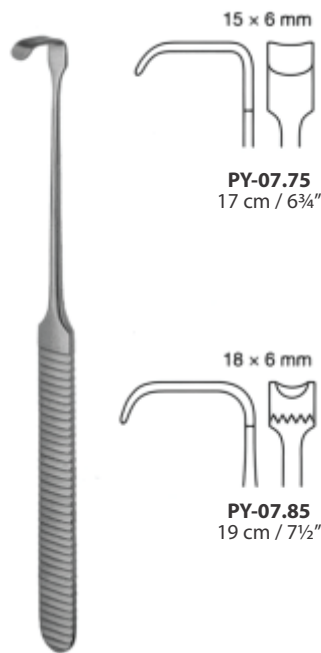

STRANDELL STILLE

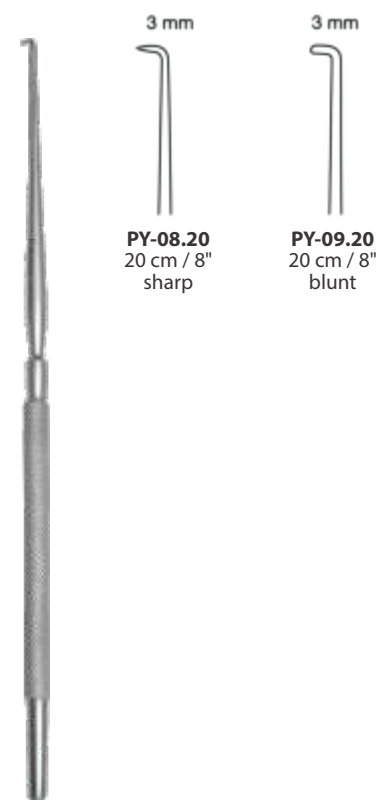

ADSON



CRILE
PY-10.20
20 cm / 8"



Dura Skin Hook



FRAZIER
PY-11.12
12.5 cm / 5"

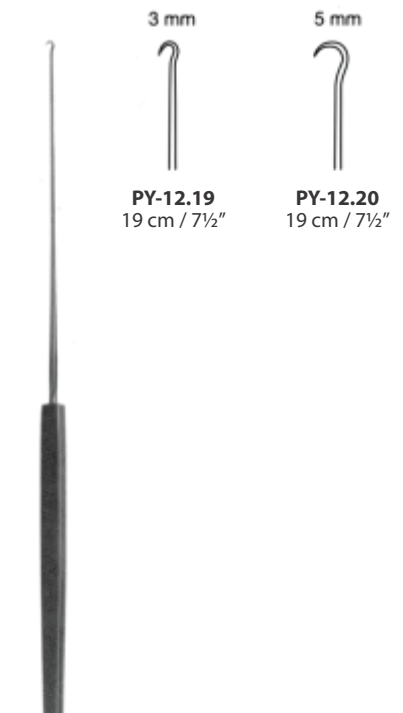

GILLIES



Delicate Retactors

Separadores fios

Ecarteurs fins

Divaricatori delicati



Delicate Retactors

Separadores fios

Ecarteurs fins,

Divaricatori delicati



NEWS
PY-24.15
15 cm / 6"



JOSEPH
PY-24.16
16 cm / 6¼"



HUMBY
PY-24.21
11.5 cm / 4½"

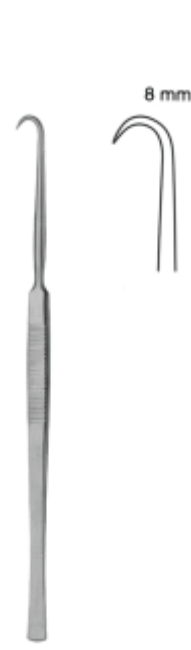

BERGMANN
PY-24.24
14 cm / 5½"



PY-24.26
16.5 cm / 6½"

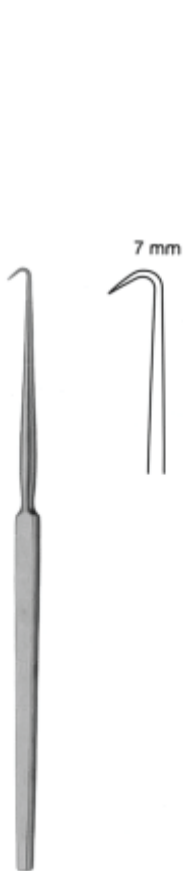

COTTLE
PY-24.36
16 cm / 6¼"



EMMET
PY-24.42
22 cm / 8¾"



BENICKE



PY-24.50
19 cm / 7½"
sharp



PY-24.51
19 cm / 7½"
blunt

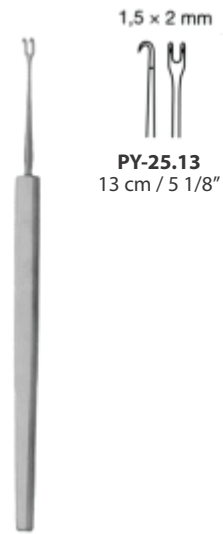

GUTHRIE



PY-25.23
13 cm / 5 1/8"



PY-25.13
13 cm / 5 1/8"

Delicate Retactors

Separadores fios

Ecarteurs fins

Divaricatori delicati

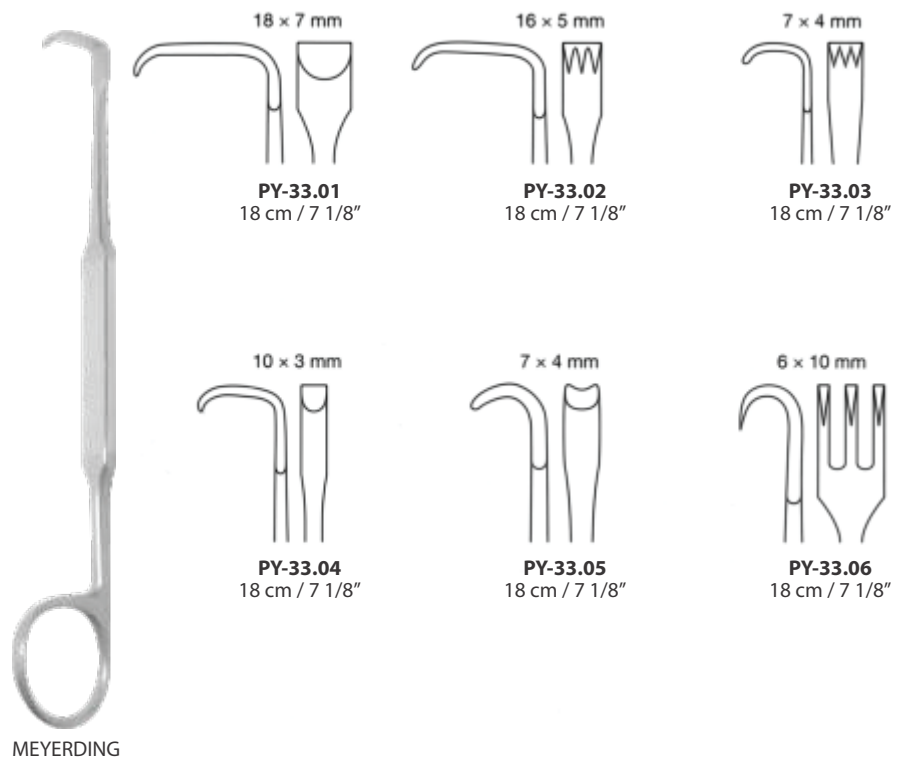
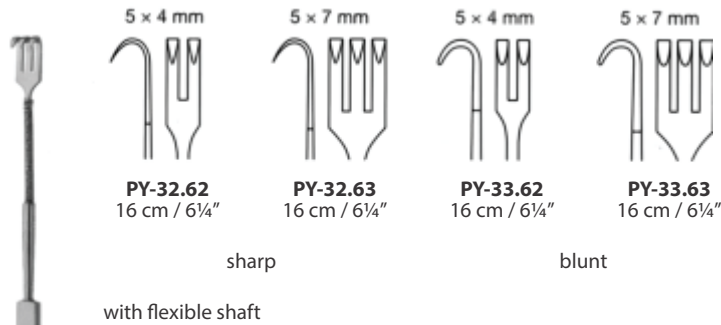
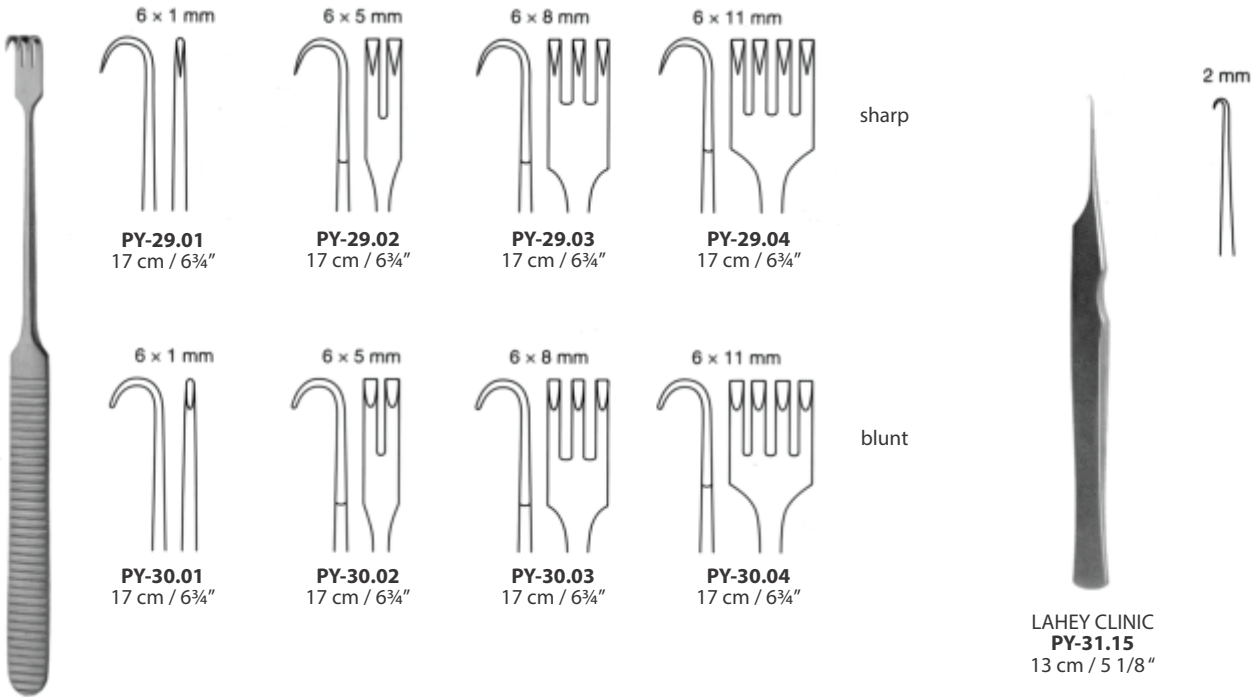

Delicate Retractors

Separadores fios

Ecarteurs fins,

Divaricatori delicati



GRUBER COLUMELLA
RETRACTOR
with weight
PAN-01.30



CLODIUS FISH HOOK
RETRACTOR
with chain
PAN-01.57 small, 7mm
PAN-01.62 large, 12mm



MAMMAPLASTY OR
MASTECTOMY
HOOK
extra large
sharp
PAN-01.79
19 cm / 7½"
10 mm



FREEMAN SKIN
HOOK
PAN-01.85 5 mm single hook
PAN-01.86 5 mm double hook
10cm / 4"



MILLARD THUMB
SINGLE HOOK
standard, 5mm
PY-101.85



MILLARD THUMB
DOUBLE HOOK
standard, 17mm
PY-101.86

Delicate Retractors

Separadores fios

Ecarteurs fins

Divaricatori delicati



FREEMAN FLAP RETRACTOR
with fiber optic illumination
PY-50.75 blade length 25mm,
20.3cm length



FARABEUFBABY
PY-46.12
12 cm / 4¾"



FARABEUFBABY
PY-47.15
15 cm / 6"



PARKER-LANGENBECK
PY-48.21 INS
21 cm / 8¼"
Set of 2

Delicate Retractors

Separadores fios

Ecarteurs fins,

Divaricatori delicati



KOCHER
21 cm / 8¼"

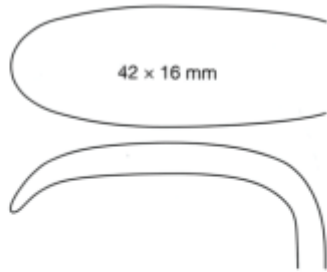

42 x 16 mm

PY-71.16

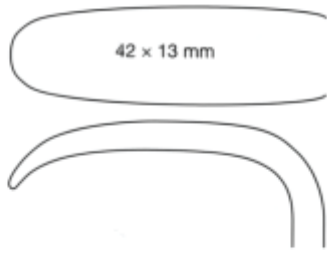

42 x 13 mm

PY-71.13



33 x 14 mm

PY-71.12

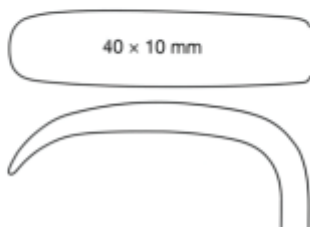

40 x 10 mm

PY-71.10

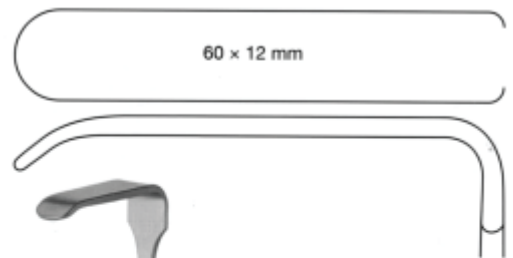

60 x 12 mm

PY-76.32



KOCHER
22 cm / 8¾"

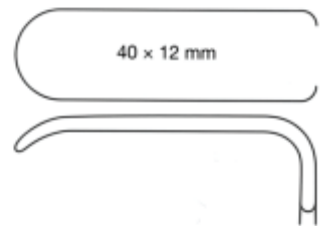

40 x 12 mm

PY-76.31

Self-retaining Retractors

Separadores autoestáticos

Ecarteurs autostatiques

Divaricatori autostatici

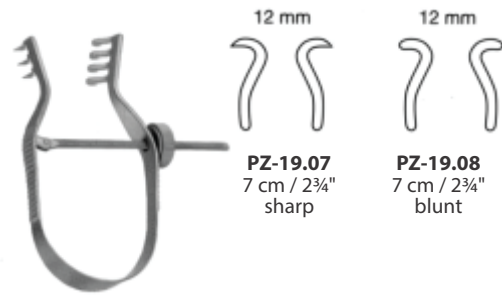
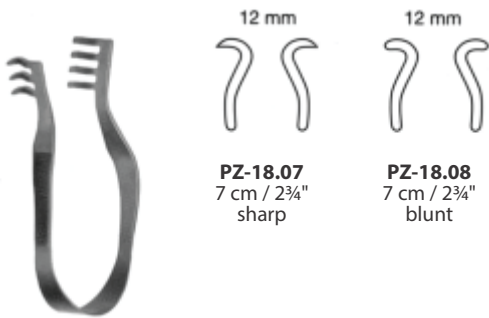
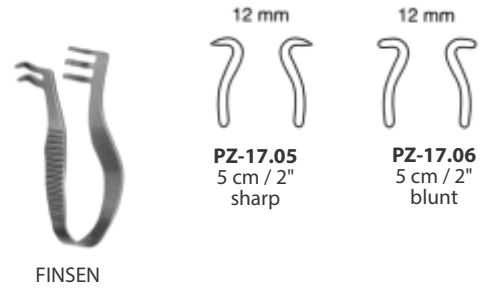
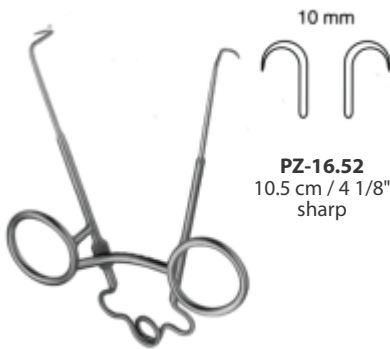
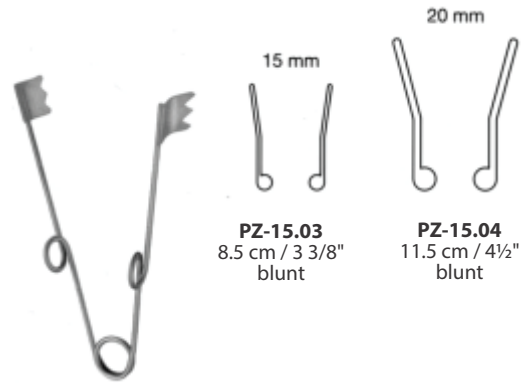
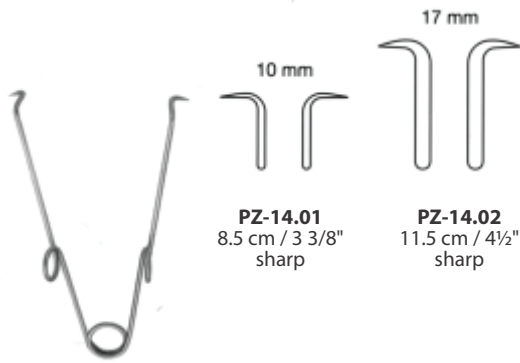

FINSEN

FINSEN

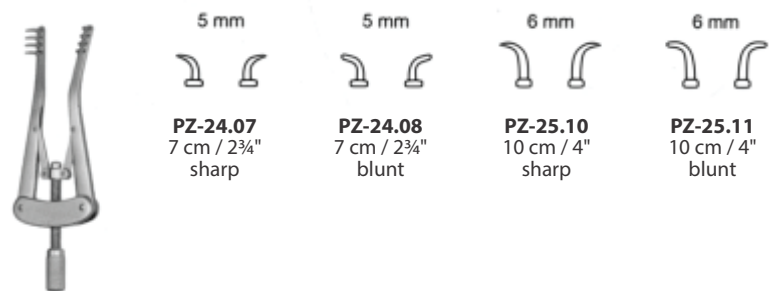
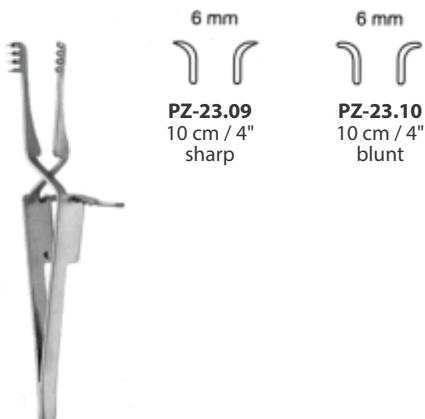

ALM

Self-retaining Retractors

Separadores autoestáticos

Ecarteurs autostatiques

Divaricatori autostatici



WEITLANER
PZ-26.13
13 cm / 5 1/8"

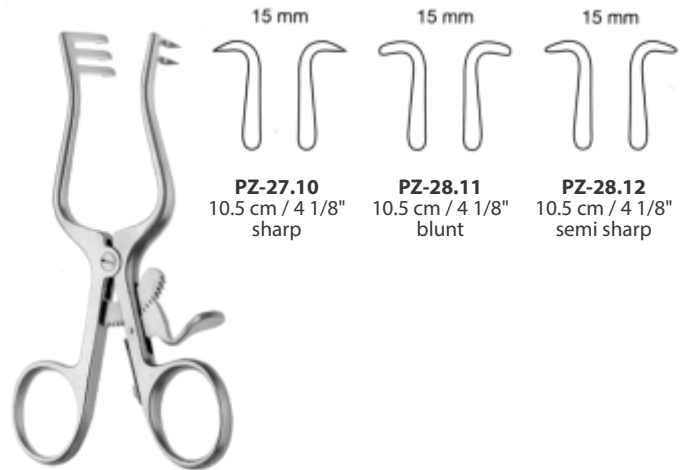

PZ-27.10
10.5 cm / 4 1/8"
sharp

PZ-28.11
10.5 cm / 4 1/8"
blunt

PZ-28.12
10.5 cm / 4 1/8"
semi sharp

WEITLANER

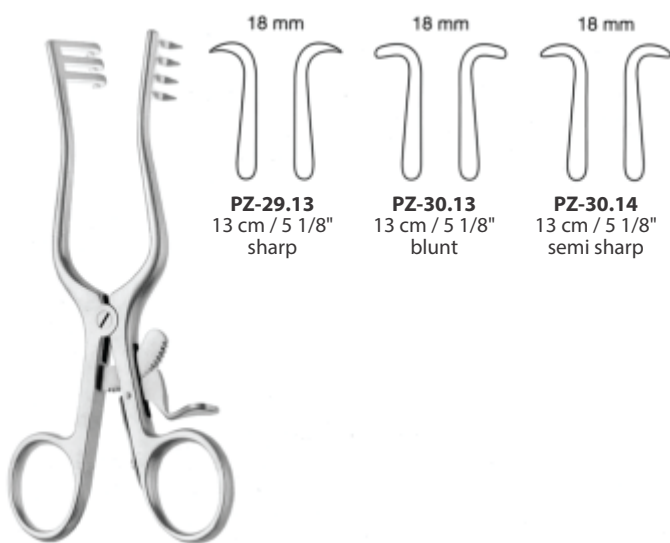

PZ-29.13
13 cm / 5 1/8"
sharp

PZ-30.13
13 cm / 5 1/8"
blunt

PZ-30.14
13 cm / 5 1/8"
semi sharp

WEITLANER

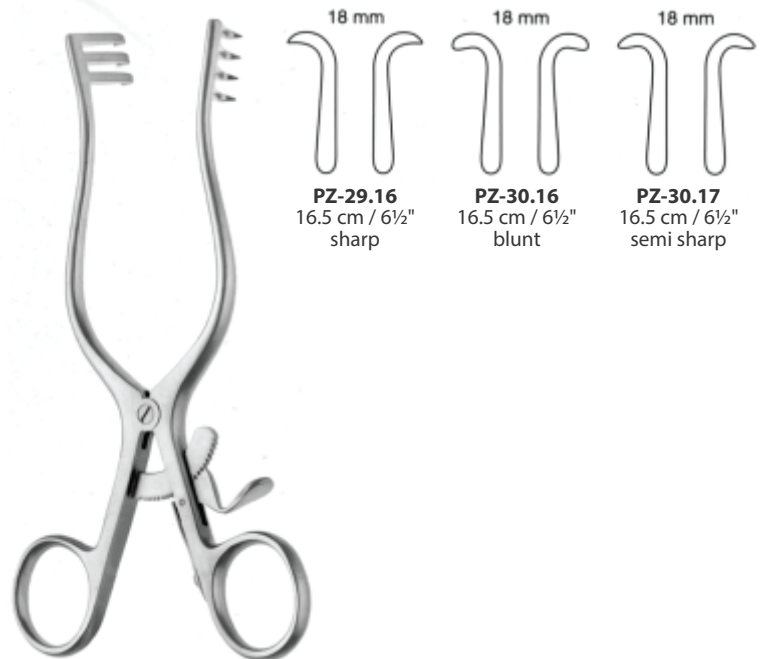

PZ-29.16
16.5 cm / 6 1/2"
sharp

PZ-30.16
16.5 cm / 6 1/2"
blunt

PZ-30.17
16.5 cm / 6 1/2"
semi sharp

WEITLANER

Retractors

Separadores

Ecarteurs

Divaricatori



YANCOSKIE CORONAL
LIFT RETRACTOR
PY-50.68 18 cm / 7"
PY-50.71 21.6 cm / 8½"



YANCOSKIE ABDOMINOPLASTY
RETRACTOR
PY-50.58 18 cm / 7"
PY-50.59 19 cm / 7½"



WALTER
PY-51.39
19 cm / 7½"

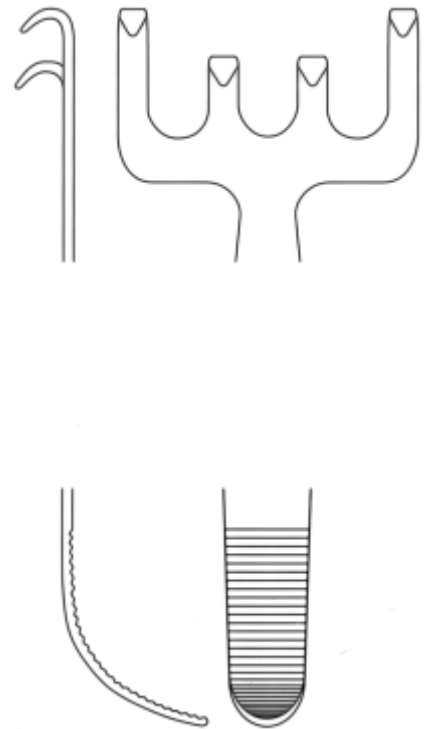

FREEMAN FACE LIFT
RETRACTOR
PY-50.10
10 cm / 4"
22 mm



FREEMAN FACE
LIFT RETRACTOR
PY-50.48 18 cm / 7"
37mm



FREEMAN FLAP
RAKE RETRACTOR
PY-50.36 10.8 cm / 4¼"
32mm



MAXWELL FLAP
PY-50.70
10 cm / 4"



GORNEY
RAKE RETRACTOR
PY-50.07 7.5 cm / 3" 38mm
PY-50.08 10.8 cm / 4¼" 38mm

Abdominal Retractor
for Lipoabdominoplasly

Separador abdominal para
la lipoabdominaoplastia

Ecarteur abdominal pour
la plastie lipo-abdominale

Divaricatore addominale
per la lipoaddominoplastica

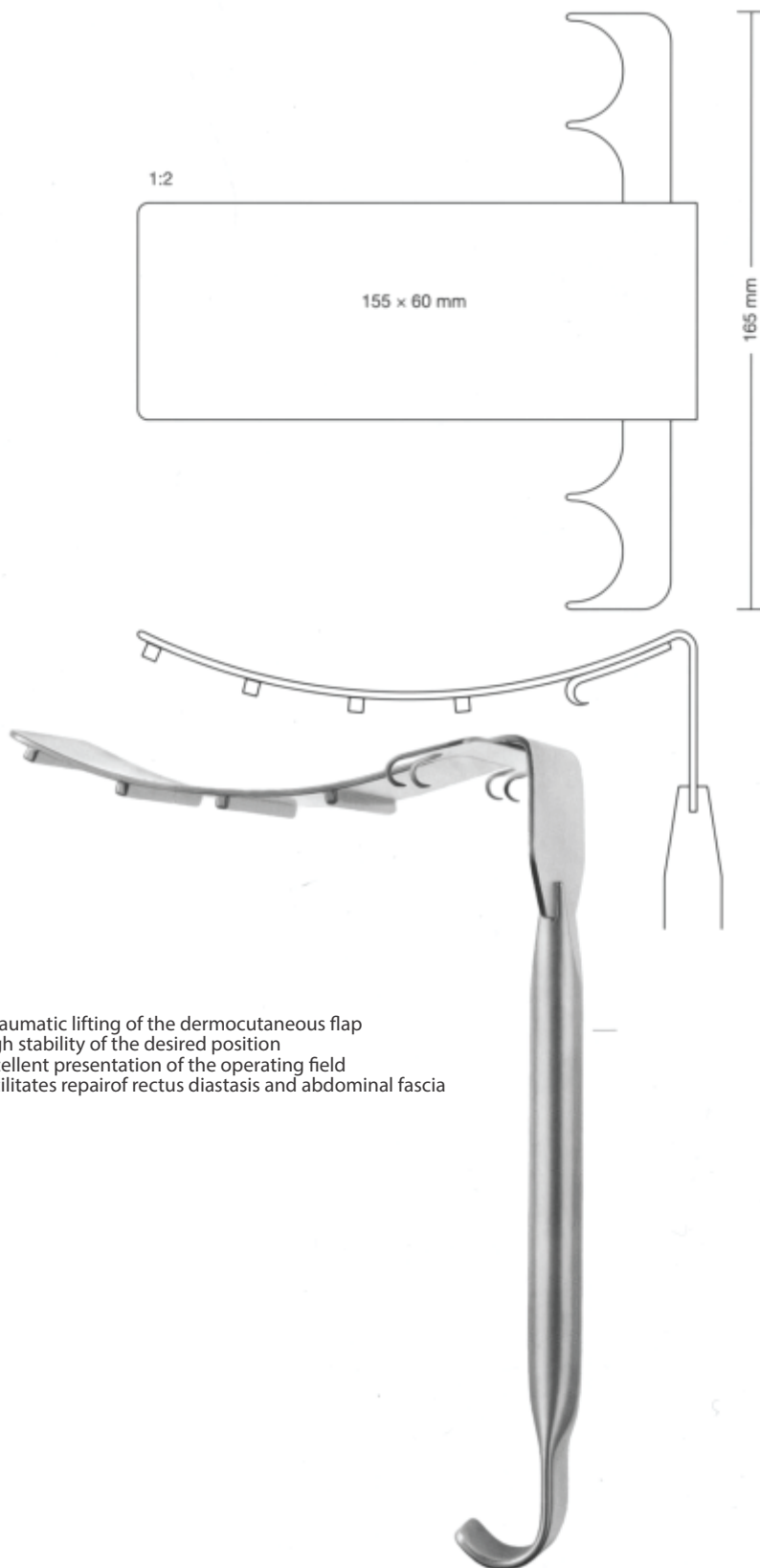

Atraumatic lifting of the dermocutaneous flap
High stability of the desired position
Excellent presentation of the operating field
Facilitates repair of rectus diastasis and abdominal fascia

SALDANHA
PY-90.50
23.5 cm / 9¼"

Retractors

Separadores

Ecarteurs

Divaricatori



OBWEGESER

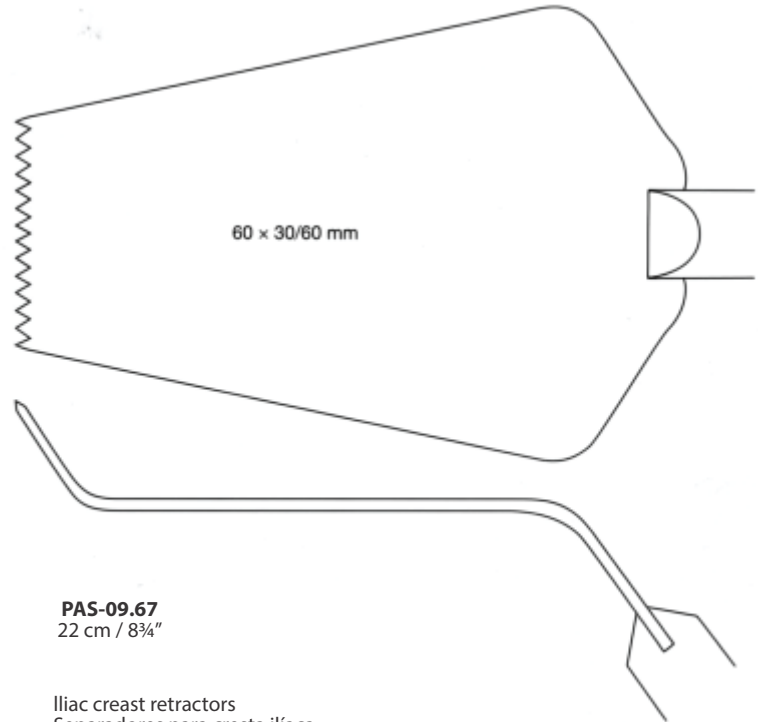

PAS-09.67
22 cm / 8¾"

Iliac crest retractors
Separadores para cresta iliaca
Ecarteurs iliaques
Divaricatori per cresta iliaca

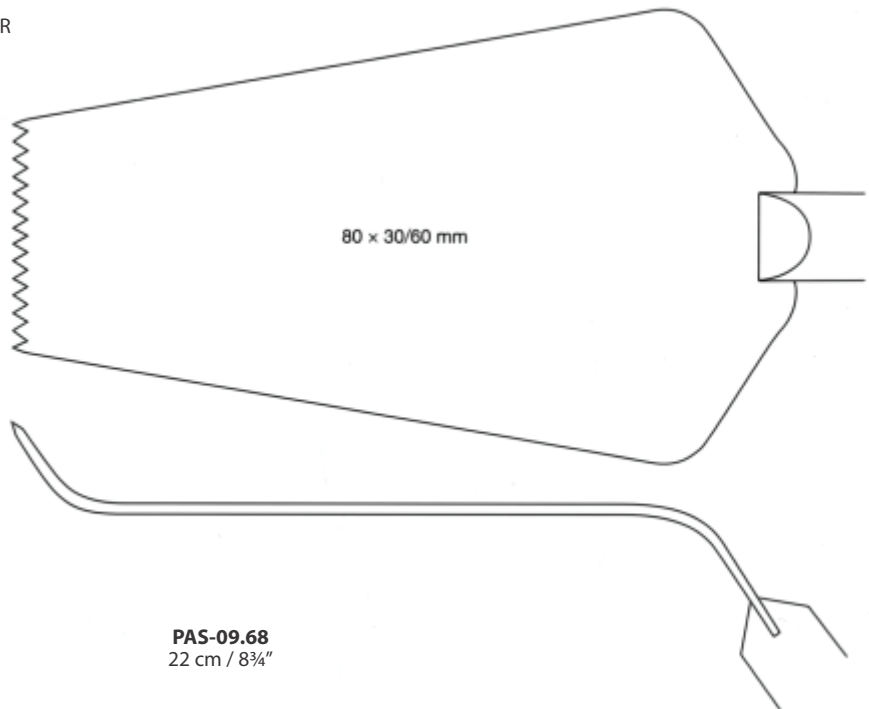

PAS-09.68
22 cm / 8¾"

Navel Marker

Posicionador de ombligo

Positionneur du nombril

Posizionatore dell'ombelico

Exact re-positioning of the navel in correspondence
 High stability of the desired position
 Excellent presentation of the operating field
 Facilitates repair of rectus diastasis and abdominal fascia

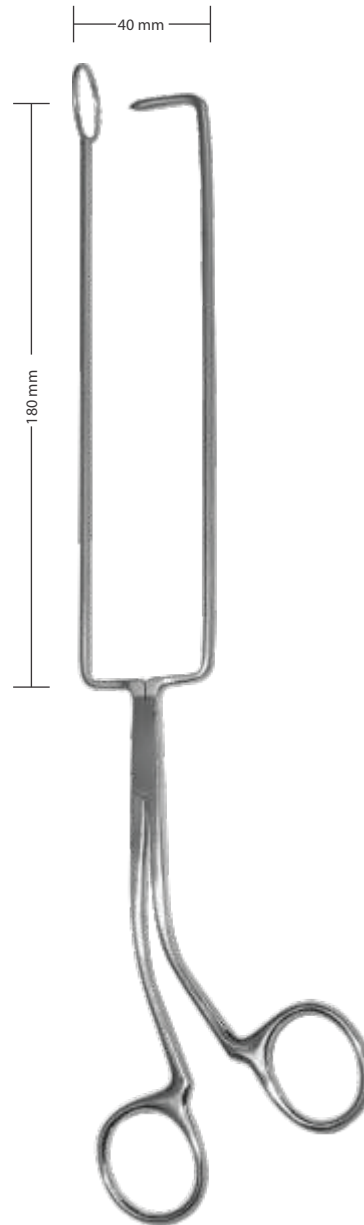

PY-97.01
 29 cm / 11 3/8"

Retractors

Separadores

Ecarteurs

Divaricatori



DESMARRES
(Insulated)

DESMARRES

8 × 10 mm



PAB-164.00
PAB-164.00 INS
14 cm / 5½"
#0

9 × 12 mm



PAB-164.01
PAB-164.01 INS
14 cm / 5½"
#1

10 × 14 mm



PAB-164.02
PAB-164.02 INS
14 cm / 5½"
#2

10 × 16 mm



PAB-164.03
PAB-164.03 INS
14 cm / 5½"
#3

12 × 18 mm



PAB-164.04
PAB-164.04 INS
14 cm / 5½"
#4

Lid Retractor

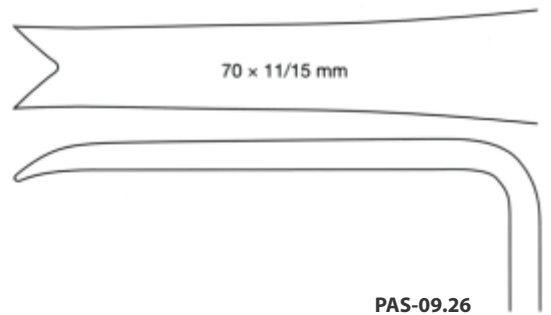

PAS-09.26

Mandibular rim retractor
Separador para el borde del maxilar inferior
Ecarteur pour le bord du maxillaire inférieur
Divaricatore per il bordo della mascella inferiore

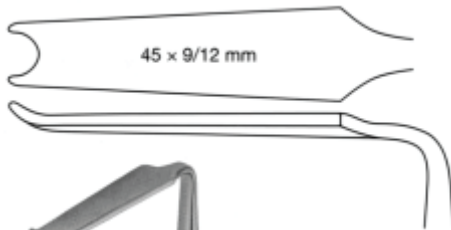

45 × 9/12 mm



OBWEGESER
PAS-09.17
17 cm / 6¾"



OBWEGESER
22 cm / 8¾"

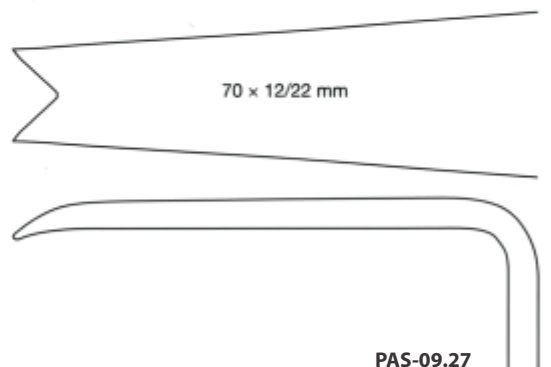

70 × 12/22 mm

PAS-09.27

Ramus Retractor

Retractors

Separadores

Ecarteurs

Divaricatori



PAS-09.31

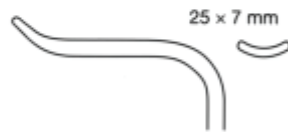

PAS-09.32



PAS-09.33



PAS-09.34



PAS-09.35



PAS-09.36



PAS-09.37

Soft tissue Retractor



OBWEGESER
23 cm / 9"

Retractors

Separadores

Ecarteurs

Divaricatori

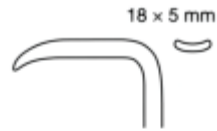

PAS-09.41

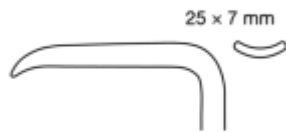

PAS-09.42

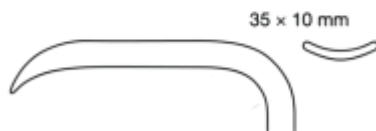

PAS-09.43



PAS-09.44



PAS-09.45

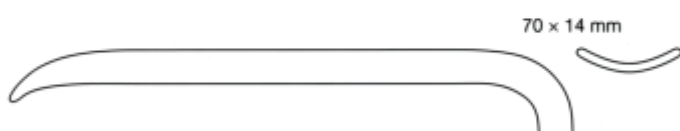

PAS-09.46

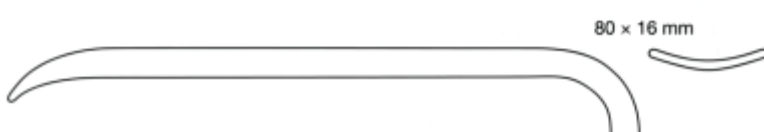

PAS-09.47

Soft tissue Retractor



OBWEGESER
22.5 cm / 9"

Retractors

Separadores

Ecarteurs

Divaricatori

Wisdom tooth retractor
 Separador para muela del juicio
 Ecarteur pour dent de sagesse
 Divaricatore per dente del giudizio



OBWEGESER
PAS-09.63
 22 cm / 8¾"

Nasal spine retractor
 Separador para espina nasal
 Ecarteur d'épine nasale
 Separatore per spina nasale



OBWEGESER
PAS-09.65
 22 cm / 8¾"

Retractors

Separadores

Ecarteurs

Divaricatori



OBWEGESER

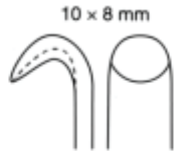

10 x 8 mm

PAS-10.26
17.5 cm / 7"

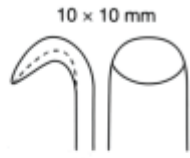

10 x 10 mm

PAS-10.27
17.5 cm / 7"

channel retractor

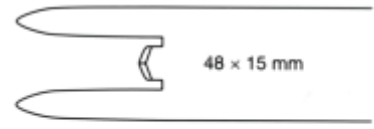

48 x 15 mm

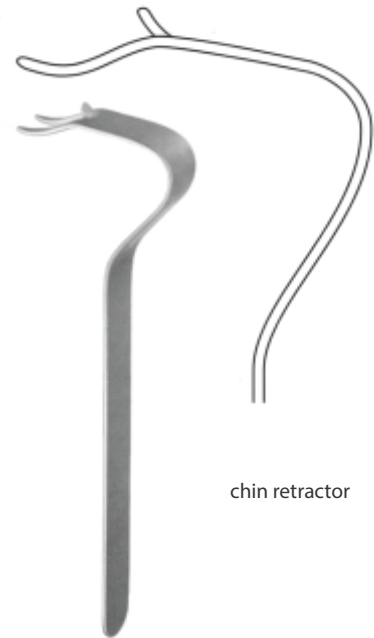

chin retractor

OBWEGESER
PAS-10.28
16 cm / 6¼"



PAG-46.11
right

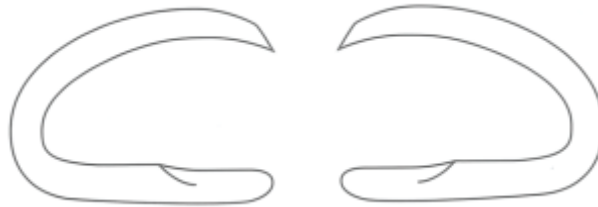

DOYEN
17 cm / 6¾"

Rib Raspatories



PAG-46.12
left

Cartilage and Bone Instruments

Instrumentos para cartilago y huesos

Instrumentos á cartilage et os

Strumenti per cartilagine e ossa

Bone Bending Pliers

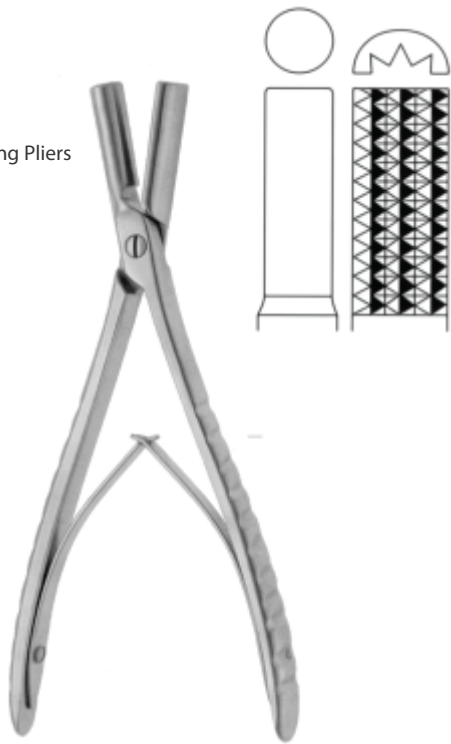

OBWEGESER
PAN-29.35
17.5 cm / 7"



OBWEGESER
PAN-29.36
17.5 cm / 7"

Septal Morslizer Forceps with protective guard

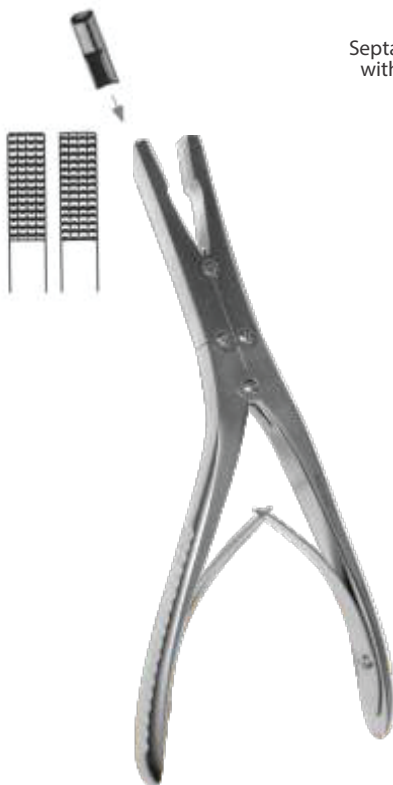

RUBIN
PAN-30.30
20 cm / 8"

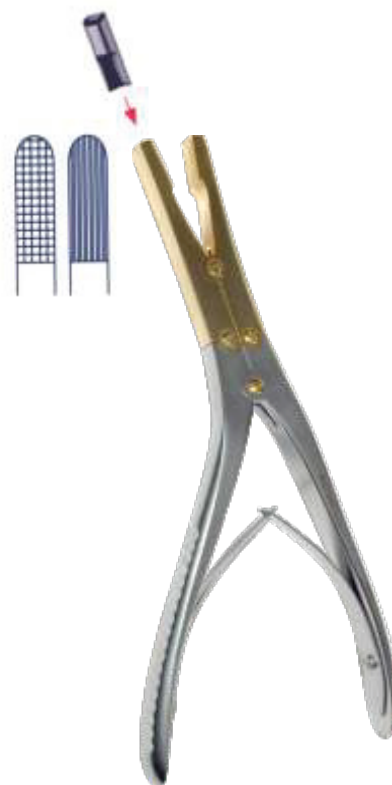

RUBIN "TC"
PAN-30.72
20 cm / 8"

Cartilage and
Bone Instruments

Instrumentos para
cartilago y huesos

Instrumenti á
cartilage et os

Strumenti per
cartilagine e ossa

Cartilage Crushers



65 x 30 x 30 mm

COTTLE
PAN-34.70



Bone mill with assembling wrench
Trituradora de hueso con llave de montaje
Moulin à os avec clé de montage
Trita ossa con chiave per montaggio

PAN-34.75
Ø 68 x 110 mm

Enables crushing of compact bone pieces
Permite moler fragmentos óseos
Pour broyage des fragments d'os
Rende possibile tritare frammenti ossei

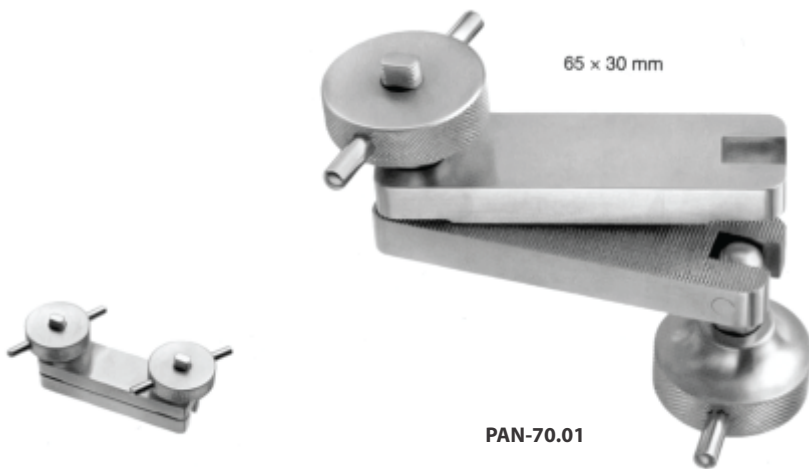

65 x 30 mm

PAN-70.01



85 x 55 x 10 mm

PAN-70.75

Cartilage cutting
block made of teflon

Lip and Cleft Palate
Instruments

Instrumentos para labios y
Fisuras paladares

Instruments pour lèvres et
fissures palatines

Strumenti per labbra e
fessure del palato



WANG
18 cm / 7 1/8"



PT-38.18
left



PT-38.19
right



WANG
18 cm / 7 1/8"

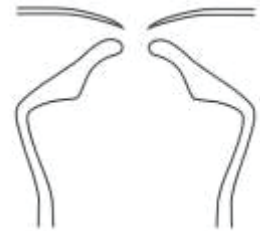

PT-38.28
left



PT-38.29
right



LANGENBECK
20 cm / 8"



PT-46.08

7 mm



PT-46.10

10 mm

Elevators
Elevadores
Elévateurs
Elevatori

Lip and Cleft Palate
Instruments

Instrumentos para labios y
Fisuras paladares

Instruments pour lèvres et
fissures palatines

Strumenti per labbra e
fessure del palato

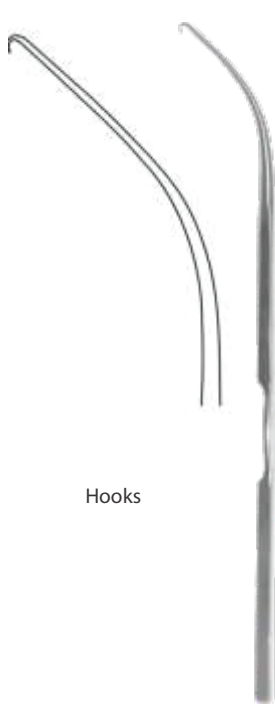

Hooks

BLOCKSMA
18 cm / 7 1/8"

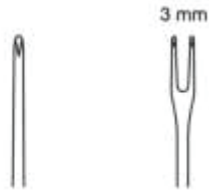

PAN-81.31

PAN-81.32

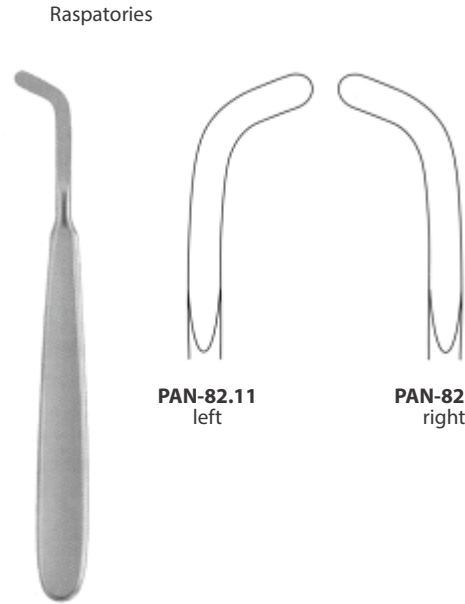

Raspatories

PAN-82.11
left

PAN-82.12
right

14 cm / 5 1/2"



KAHRE
PAN-82.20
17 cm / 6 3/4"



MCINDOE
PAN-82.25
16.5 cm / 6 1/2"

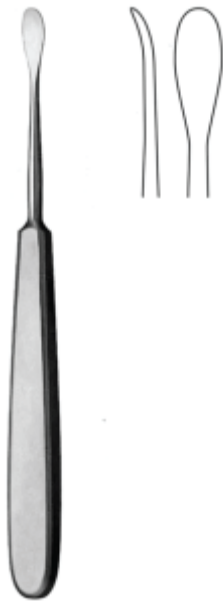

WANG
PAN-82.80
15.5 cm / 6 1/8"

Lip and Cleft Palate
Instruments

Instrumentos para labios y
Fisuras paladares

Instruments pour lèvres et
fissures palatines

Strumenti per labbra e
fessure del palato

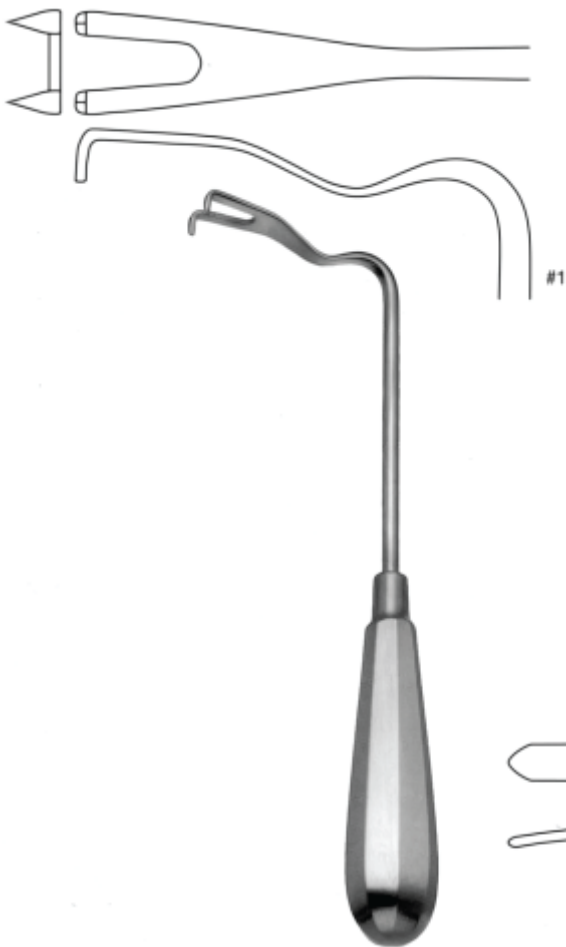

PAS-07.35
19 cm / 7½"



PAS-07.36
19 cm / 7½"

Mucoperiost Retractors



PAS-07.37
19 cm / 7½"

Lip and Cleft Palate
Instruments

Instrumentos para labios y
Fisuras paladares

Instruments pour lèvres et
fissures palatines

Strumenti per labbra e
fessure del palato



STERNBERG
PAS-03.04
14.5 cm / 5¾"

with tongue depressor



UNIV. MINNESOTA
PAS-03.34
15.5 cm / 6 1/8"



PAEGER LID PLATE
PAB-141.08 INS
(Insulated)



for upper jaw
para maxilar
pour maxillaire supérieure
per mascella

PAS-15.21
21 cm / 8¼"

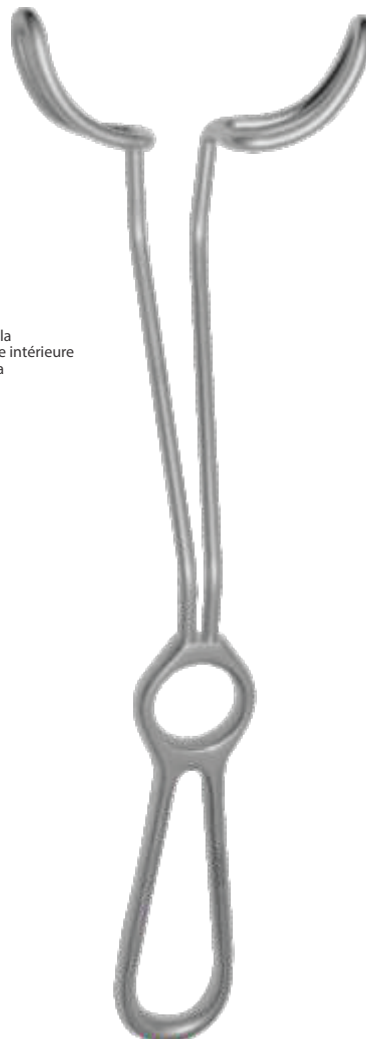

for lower jaw
para mandibula
pour maxillaire inférieure
per mandibola

PAS-15.26
26 cm / 10¼"



Univer:
univers
univers
univers

PAS-15.27
15 cm / 6"

Wires and Wire Instruments

Alambre y Instrumentos para alambre

Fils et instruments pour fils métalliques

Fili e strumenti per fili d'acciaio

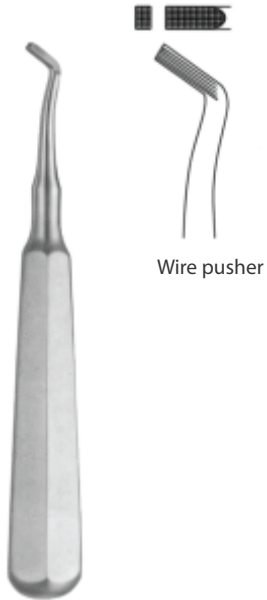

MERSHON
PU-04.50
14.5 cm / 5¾"

Wire pusher

wire twisting forceps



NIRO "TC"
PU-04.65
15 cm / 6"

wire loop forceps



OBWEGESER
PU-04.76
15.5 cm / 6 1/8"



OBWEGESER "TC"
PU-48.43
13 cm / 5 1/8"

wire twister

Bone wire soft



10 m roll

PU-74.20

Thickness of wire = Ø 0.5 mm



5 mm



AIACH
PU-50.56
16 cm / 6¼"

fixation wire with needles

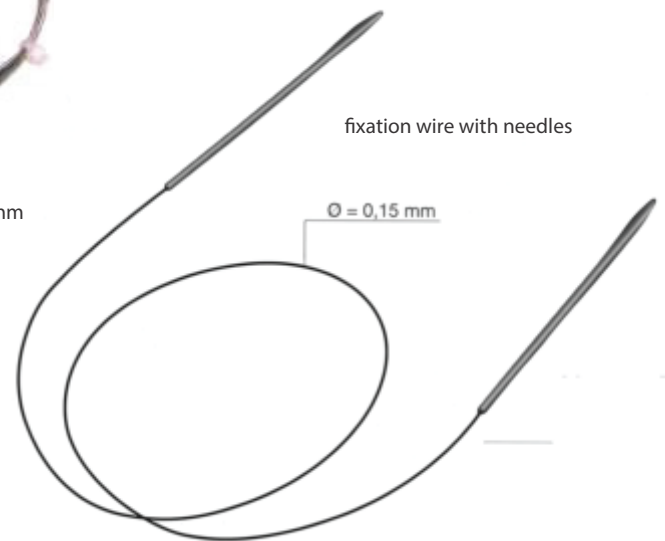

Ø = 0,15 mm

PU-75.40
20 cm / 8"

Packing unit 20 pieces (sterile)

Mouth Gags

Abrebocas

Ouvre-bouches

Apribocca



MOLT

PAQ-06.10
10 cm / 4"
for children

PAQ-07.15
15 cm / 6"
for adults



ROSER KONIG
PAQ-13.45
16 cm / 6¼"



DENHART
PAQ-14.60
13 cm / 5 1/8"

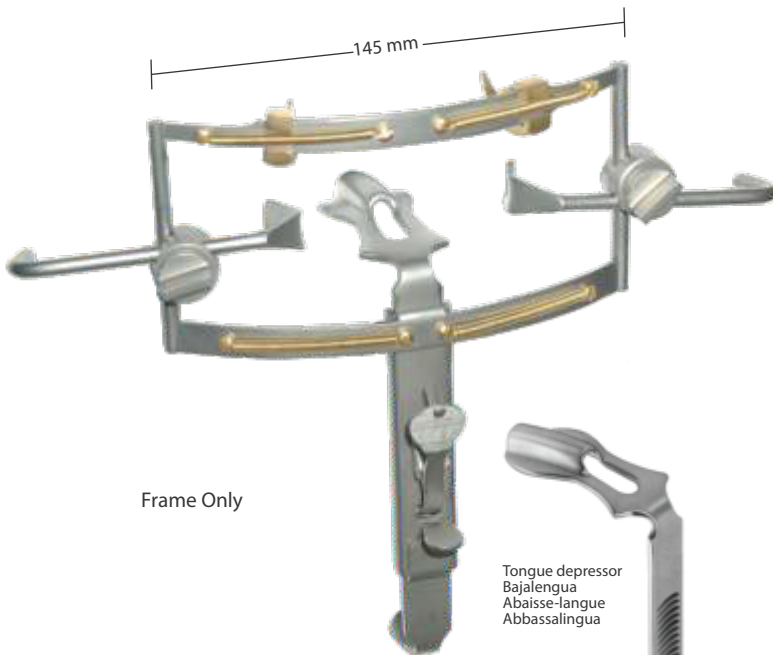

Frame Only

DINGMAN
PAQ-18.00

Tongue depressor
Bajalengua
Abaisse-langue
Abbassalingua

PAQ-18.11
55 x 25 mm
Fig.1

PAQ-18.12
60 x 27 mm
Fig.2

PAQ-18.13
70 x 30 mm
Fig.3

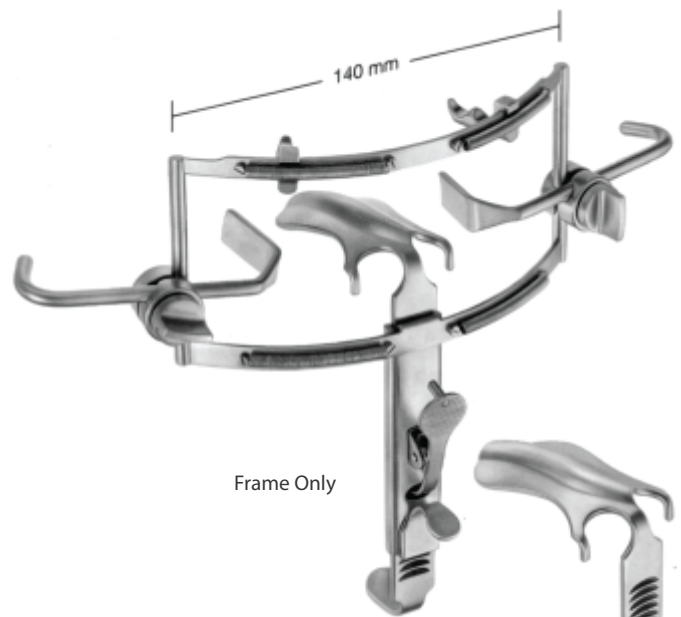

Frame Only

WANG
PAQ-19.00

Tongue depressor
Bajalengua
Abaisse-langue
Abbassalingua

PAQ-19.05
55 x 32 mm
Fig.1

PAQ-19.06
60 x 35 mm
Fig.2

PAQ-19.07
75 x 38 mm
Fig.3



Rhinoplasty Instruments

Nasal Dressing Forceps

Pinzas nasales para tamponamiento

Pinces à pansements pour le nez

Pinze per tamponamento nasale

Delicate Pattern



HARTMANN
PAM-04.16
18 cm / 7 1/8"

Standard Pattern



HARTMANN
PAM-05.20
20 cm / 8"

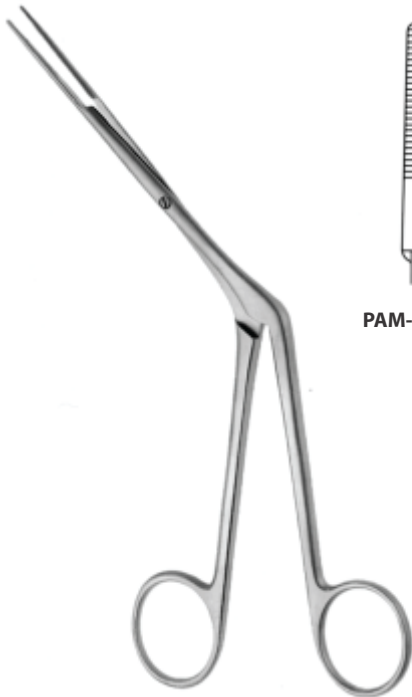

WESTMACOTT
20 cm / 8"

PAM-06.20

PAM-06.21



LUBET BARBON
PAM-06.30
20 cm / 8"

Nasal Specula

Espéculos nasales

Spéculums nasaux

Specoli nasali



HARTMANN



PAM-08.15
15 cm / 6"



PAM-08.16
15 cm / 6"

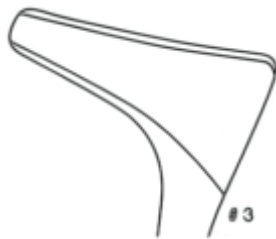

PAM-08.17
15 cm / 6"



TIECK HALLE



PAM-09.12
13.5 cm / 5 3/4"

for babies



PAM-09.13
13.5 cm / 5 3/4"

for infants

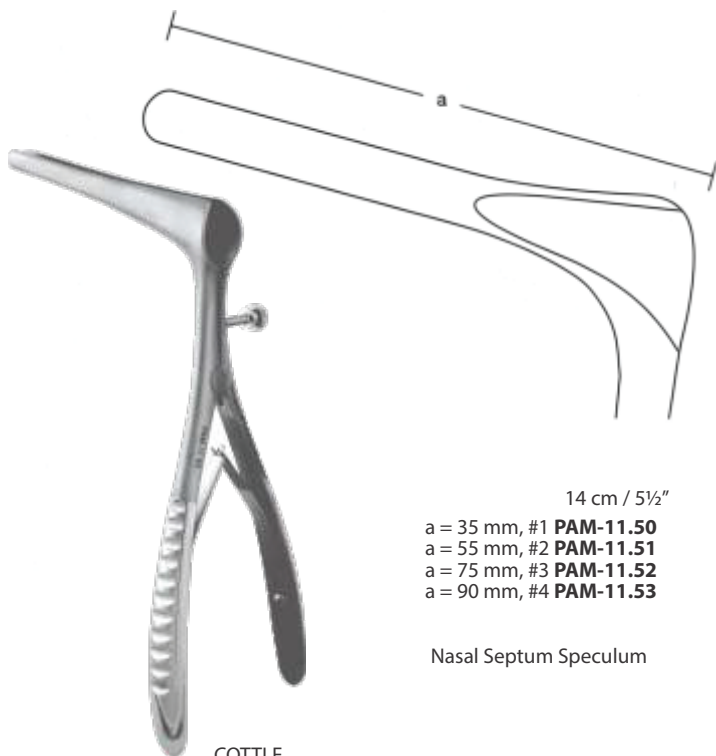

COTTLE

14 cm / 5 1/2"

- a = 35 mm, #1 **PAM-11.50**
- a = 55 mm, #2 **PAM-11.51**
- a = 75 mm, #3 **PAM-11.52**
- a = 90 mm, #4 **PAM-11.53**

Nasal Septum Speculum



COTTLE
PAM-11.60
14 cm / 5 1/2"



KILLIAN SPECULUM
with fiber optic illumination
14cm length
PAM-42.35 blade length 35mm
PAM-42.50 blade length 50mm
PAM-42.75 blade length 75mm
PAM-42.90 blade length 90mm

Nasal Specula

Espéculos nasales

Spéculums nasaux

Specoli nasali



COTTLE
PAM-11.62
13 cm / 5 1/8"



"MOD. WIEN"



PAM-16.15
14 cm / 5 1/2"



PAM-16.16
14 cm / 5 1/2"



PAM-16.17
14 cm / 5 1/2"

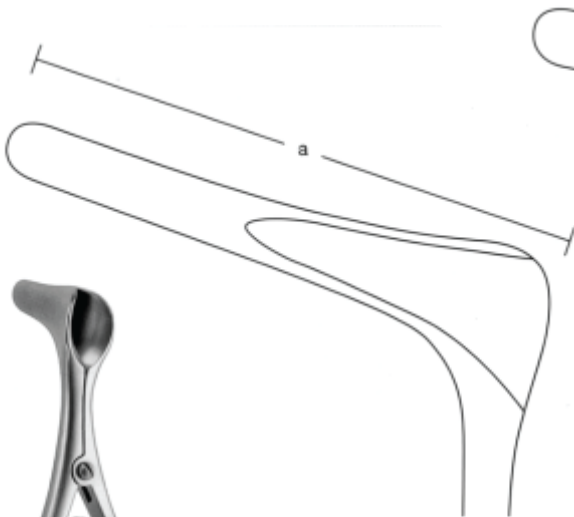

14 cm / 5 1/2"

- a = 35 mm, #1 PAM-14.14
- a = 50 mm, #2 PAM-14.15
- a = 75 mm, #3 PAM-14.16
- a = 90 mm, #4 PAM-14.17



KILLIAN

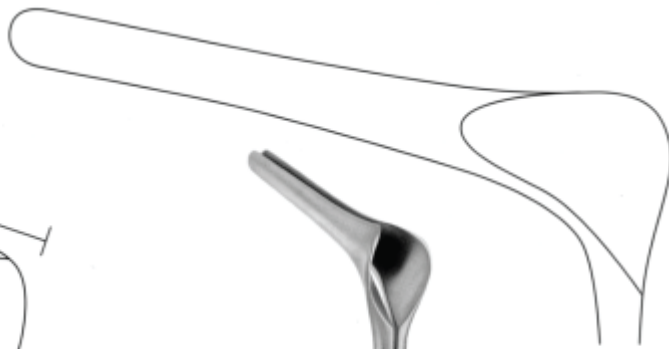

KILLIAN
PAM-14.59
14 cm / 5 1/2"



COTTLE
PAN-67.11
11 cm / 4 3/8"

Columella Forceps

Nasal Retractors

Separadores ansales

Ecarteurs nasaux

Divaricatori nasali

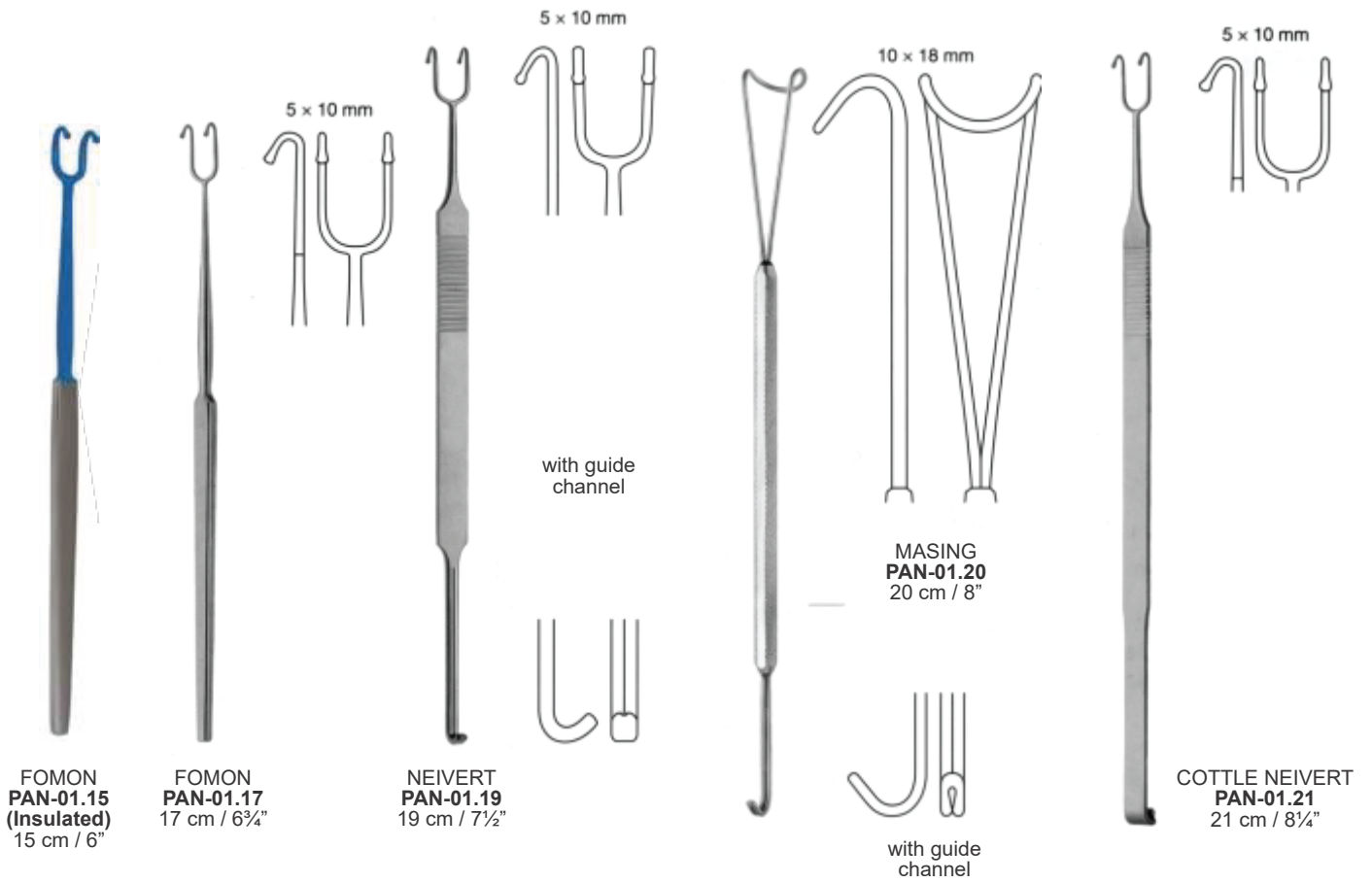

Alar Retractor

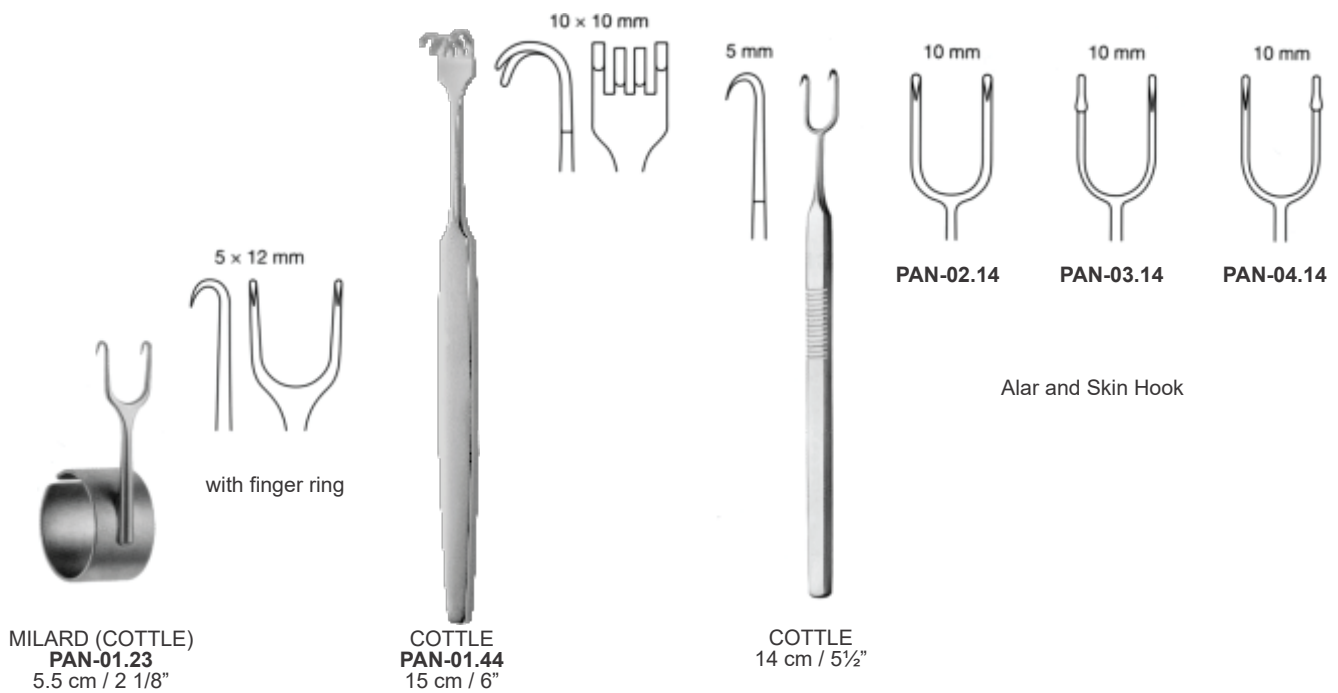

Nasal Retractors

Separadores ansales

Ecarteurs nasaux

Divaricatori nasali



COTTLE
PAN-04.15
15 cm / 6"



KILNER
PAN-04.10
10 cm / 4"

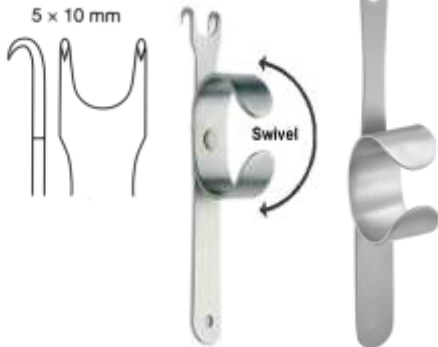

Swivel
PAN-04.20
9 cm / 3½"
with Swivel Ring

MARTINEZ-KILNER
PAN-04.25
11.4 cm / 4½"
7.5mm width

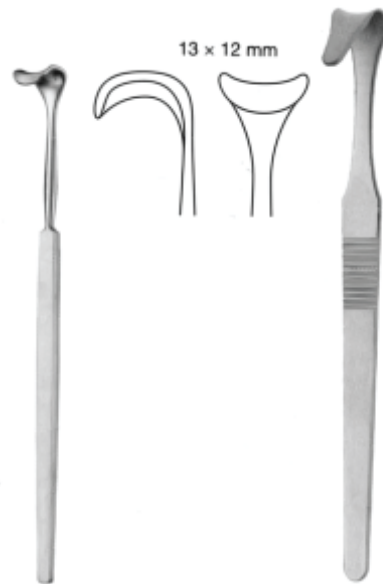

COTTLE
PAN-05.14
14 cm / 5½"

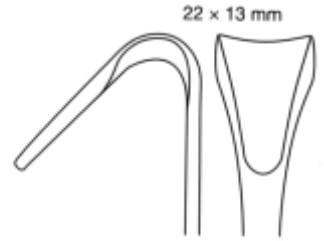

Alar Retractor

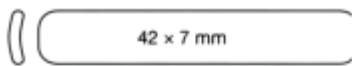

PAN-06.14

AUFRICHT WALTER
13.5 cm / 5 3/8"



5 x 9 mm

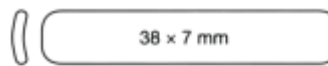

PAN-06.15



8 x 9 mm



AUFRICHT
PAN-06.17
13.5 cm / 5 3/8"

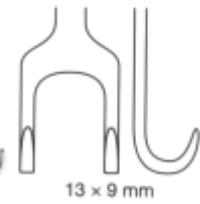

13 x 9 mm

Nasal Retractors

Separadores anales

Ecarteurs nasaux

Divaricatori nasali



PAN-06.30
18.5 cm / 7¼"

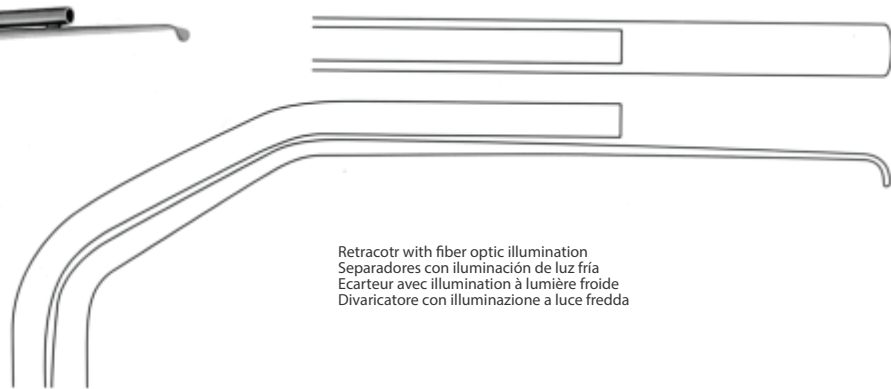

Retractor with fiber optic illumination
Separadores con iluminación de luz fría
Ecarteur avec illumination à lumière froide
Divaricatore con illuminazione a luce fredda

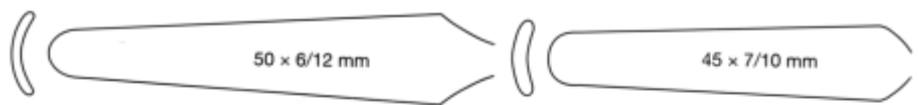

10 x 14 mm



CONVERSE
PAN-09.10
10 cm / 4"
Blunt



CONVERSE
PAN-09.12
12 cm / 4¾"
Sharp

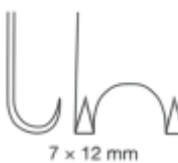

AUFRICHT
PAN-10.17
17 cm / 6¾"



AUFRICHT
PAN-10.19
18 cm / 7 1/8"

Nasal Retractors

Separadores ansales

Ecarteurs nasaux

Divaricatori nasali



AUFRICHT NASAL RETRACTOR
with fiber optic light guide
PAN-10.70 7mm tip, 45mm blade, 16cm/ 6¼"
PAN-10.73 10mm tip, 45mm blade, 18cm/ 7"



CONVERSE BLADE NASAL RETRACTOR
with fiber optic light guide
PAN-10.81 20 x 10mm wide
PAN-10.82 30 x 12mm wide
PAN-10.83 40 x 12mm wide
PAN-10.84 50 x 12mm wide



MALINIAC NASAL RETRACTOR
PAN-10.35

Rhinoplasty Knives

Cuchillos para rinoplastía

Couteaux pour rhinoplastie

bisturi per rinoplastica



COTTLE
PAN-11.08
14 cm / 5½"

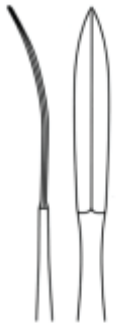

JOSEPH
PAN-12.15
15 cm / 6"



COTTLE
PAN-13.14
14 cm / 5½"



JOSEPH
PAN-13.16
16 cm / 6¼"



Septum Cartilage Knife



CONVERSE
PAN-14.15
15 cm / 6"



COTTLE
PAN-15.14
14 cm / 5½"



JOSEPH
PAN-17.26
12.5 cm / 5"

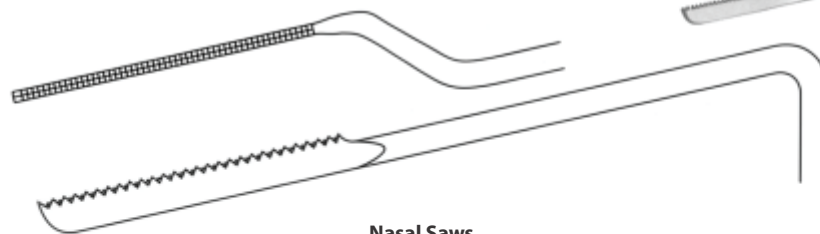
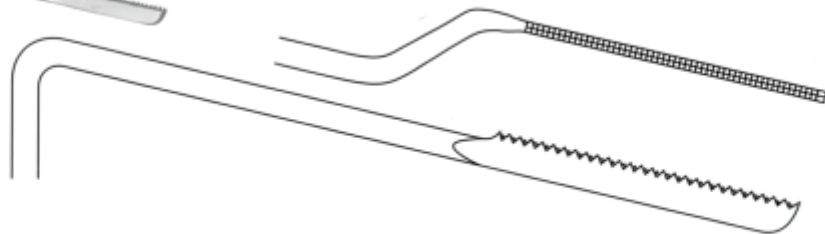

Nasal Saws
Sierras nasales
Scies nasales
Seghe nasali

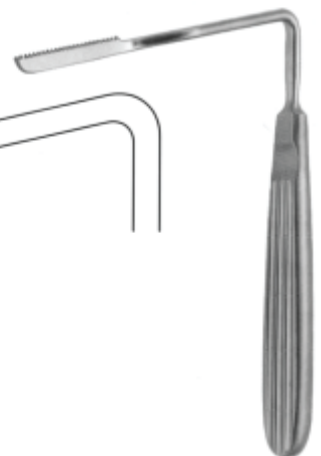

JOSEPH
PAN-17.27
12.5 cm / 5"

Nasal Rasps

Raspadores nasales

Râpes nasales

Raspe nasali



JOSEPH
17 cm / 6¾"



PAN-20.24
left



PAN-18.24
right

Nasal Saws
Sierras nasales
Scies nasales
Seghe nasali



JOSEPH
PAN-19.24
17 cm / 6¾"



COTTLE
PAN-21.24
21 cm / 8¼"



COTTLE
PAN-21.25
20.5 cm / 8"

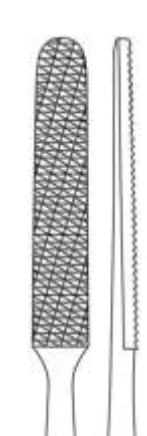

Tungsten Carbide



MALTZ
PAN-22.25
18.5 cm / 7¼"

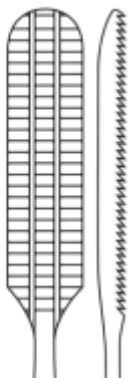

PAN-23.47
19.5 cm / 7¾"

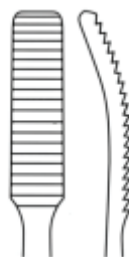

LEWIS
PAN-23.50
19.5 cm / 7¾"

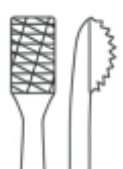

Nasal Rasps

Raspadores nasales

Râpes nasales

Raspe nasali

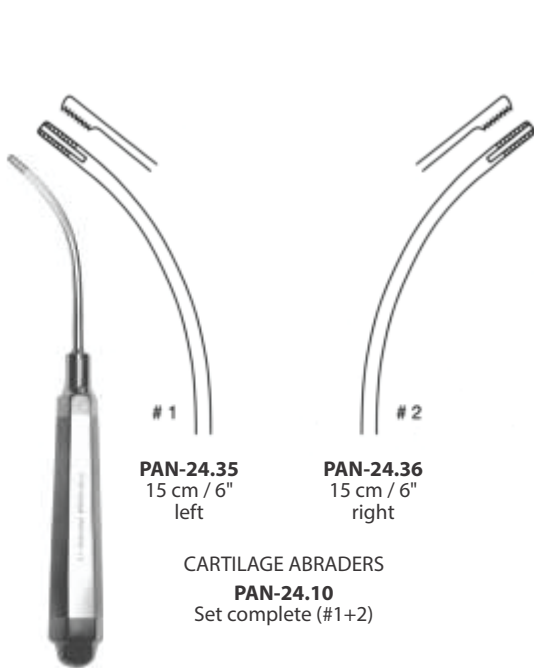

PAN-24.35
15 cm / 6"
left

PAN-24.36
15 cm / 6"
right

CARTILAGE ABRADERS
PAN-24.10
Set complete (#1+2)

DINGMAN



LEWIS
PAN-24.26
20 cm / 8"

KISTLER

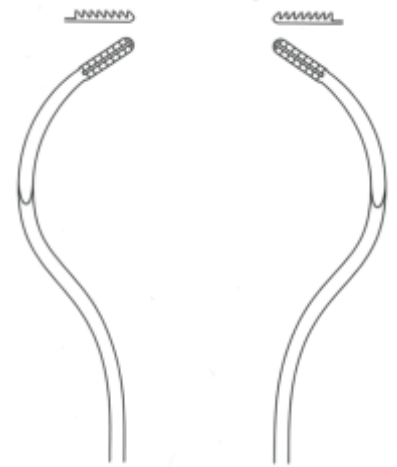

PAN-24.55
16 cm / 6¼"

PAN-24.56
16 cm / 6¼"

For smooth the bony nasal pyramid



PAN-25.00
14 cm / 5½"

PAN-25.01
14 cm / 5½"

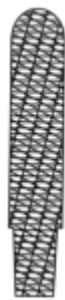

PAN-25.10
Fig. 1

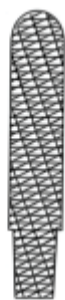

PAN-25.11
Fig. 2



PAN-25.12
Fig. 3



PAN-25.13
Fig. 4



PAN-25.14
Fig. 5

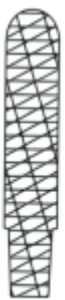

PAN-25.15
Fig. 6



PAN-25.16
Fig. 7

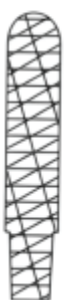

PAN-25.17
Fig. 8



PAN-25.18
Fig. 9



PAN-25.19
Fig. 10



WRENCH
PAN-25.03

Nasal Rasps

Raspadores nasales

Râpes nasales

Raspe nasali

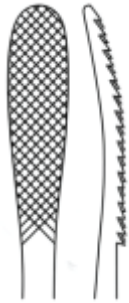

PAN-25.26
21 cm / 8¼"

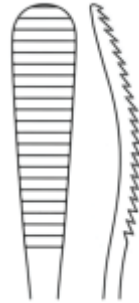

PAN-25.27
21 cm / 8¼"

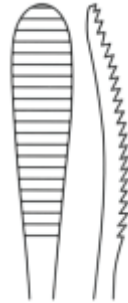

PAN-25.28
21 cm / 8¼"

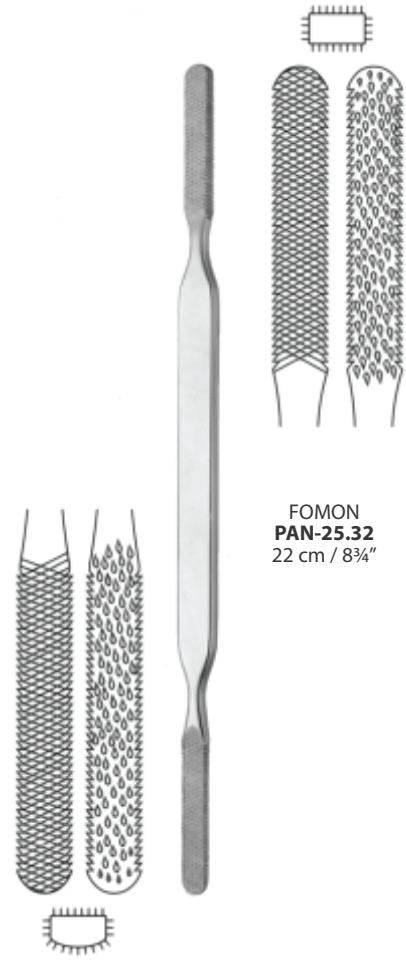

FOMON
PAN-25.32
22 cm / 8¾"

AUFRICHT

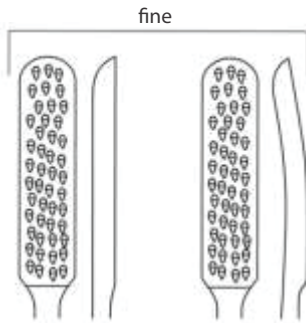

PAN-25.41

PAN-25.43

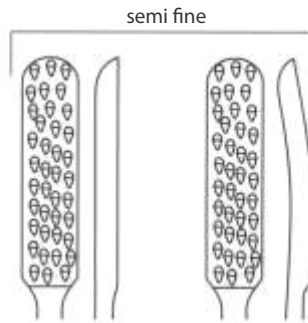

PAN-25.42

PAN-25.44

One working end of the rasp operates by pushing, the other by pulling.

OBWEGESER
19 cm / 7¾"

fine

semi fine

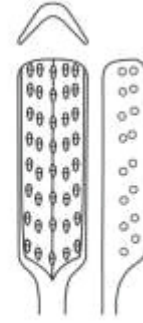

PAN-25.45

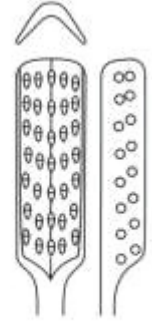

PAN-25.46

Bone splinters are pushed through the perforated working ends. This avoids plugging of the rasps and they can be cleaned easily.

OBWEGESER
19 cm / 7¾"

Nasal Rasps

Raspadores nasales

Râpes nasales

Raspe nasali

Nasenfeile
Nasal file
Lima nasal

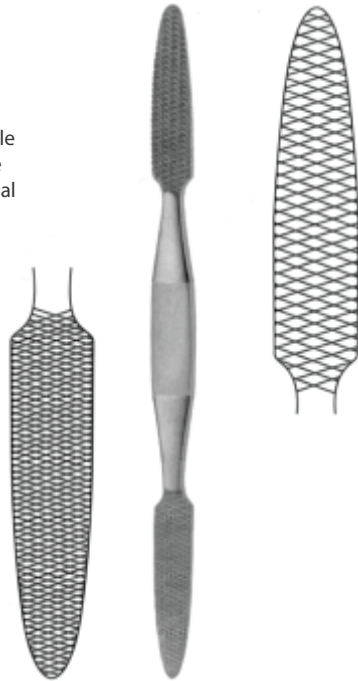

CONVERSE
PAN-25.65
18.5 cm / 7¼"

Nasenfeile
Nasal file
Lima nasal

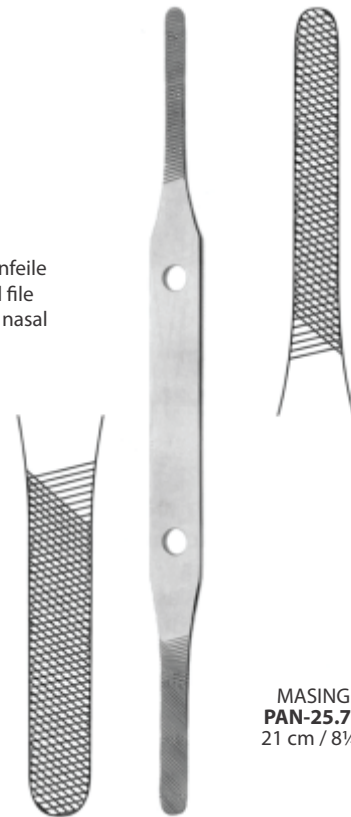

MASING
PAN-25.70
21 cm / 8¼"

Nasenraspel
Nasal rasp
Raspador nasal

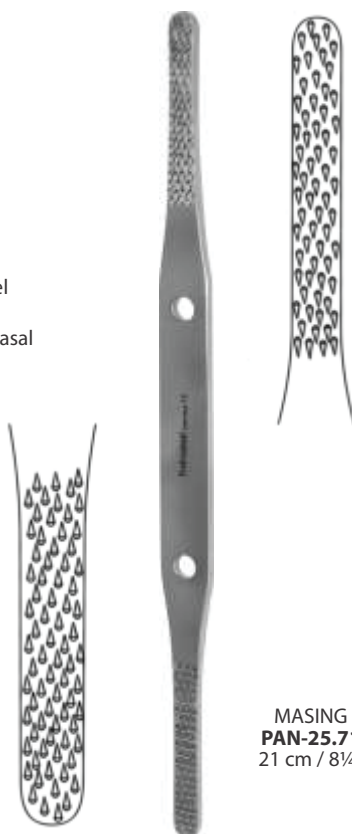

MASING
PAN-25.71
21 cm / 8¼"

Nasenraspel
Nasal rasp
Raspador nasal



FOMON "TC"
PAN-26.30
20 cm / 8"

Nasal Septum Forceps

Pinzas para el tabique nasal

Pinces pour la cloison nasale

Pinze per il setto nasale



PAM-34.11

PAM-34.12

LUC BRUNINGS
(HEYMANN)
18 cm / 7 1/8"



CRAIG
PAM-34.15
17 cm / 6 3/4"



PAM-34.16

PAM-34.17

Vomer Forceps

CRAIG DOMNICK
17 cm / 6 3/4"



HEYMANN
PAM-34.75
18 cm / 7 1/8"

Nasal Forceps

Pinzas nasal

Pinces nasale

Pinze nasali

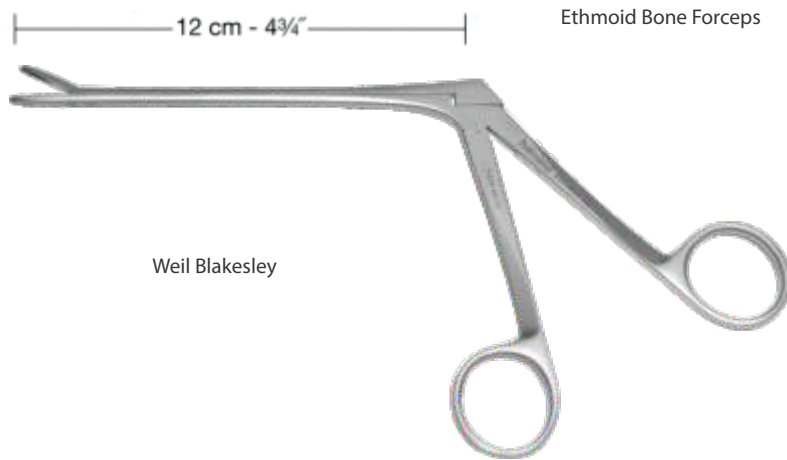

	straight	angled upwards 45°	angled upwards 90°
		45°	90°
3,0 mm			
	PAM-44.01	PAM-45.01	PAM-45.11
3,6 mm			
	PAM-44.02	PAM-45.02	PAM-45.12
with normal shaft	4,2 mm	4,2 mm	4,2 mm
	PAM-44.03	PAM-45.03	PAM-45.13
4,8 mm	PAM-44.04	PAM-45.04	PAM-45.14
5,6 mm	PAM-44.05	PAM-45.05	PAM-45.15
		45°	
3,0 mm			
	PAM-44.71	PAM-44.81	
3,6 mm			
	PAM-44.72	PAM-44.82	
with slim shaft	4,2 mm	4,2 mm	
	PAM-44.73	PAM-44.83	
4,8 mm	PAM-44.74	PAM-44.84	
5,6 mm	PAM-44.75	PAM-44.85	

Nasal Forceps

Pinzas nasal

Pinces nasale

Pinze nasali

11,5 cm - 4½"



WEIL BLAKESLEY

2,0 mm 

PAM-44.26

2,5 mm 

PAM-44.27

3,0 mm 

PAM-44.28

straight



angled upwards



45°

PAM-44.35

PAM-44.76

PAM-44.37

11,5 cm - 4½"



BLAKESLEY

straight



PAM-44.59

angled upwards



PAM-44.60

angled upwards



PAM-44.61

45°

90°

3,0 mm 

Septum Forceps

Pinzas para tabique nasal

Pinces pour la cloison nasale

Pinze per il setto nasale



Septum Straightening forceps
Septumrichtzange
Pinza para enderezar el tabique nasal

ASCH
PAN-29.21
22 cm / 8¾"



COTTLE FOMON
PAN-30.24
21 cm / 8¼"

dismantable
zerlegbar
desmontable



WALSHAM "UNIVERSAL"
PAN-30.21
23 cm / 9"



WALSHAM



PAN-30.22
23 cm / 9"

rechts
right
derecha



PAN-30.23
23 cm / 9"

links
left
izquierda

Septum straightening forceps
Septumrichtzangen
Pinzas para enderezar el tabique nasal

Septum Forceps

Pinzas para tabique nasal

Pinces pour la cloison nasale

Pinze per il setto nasale

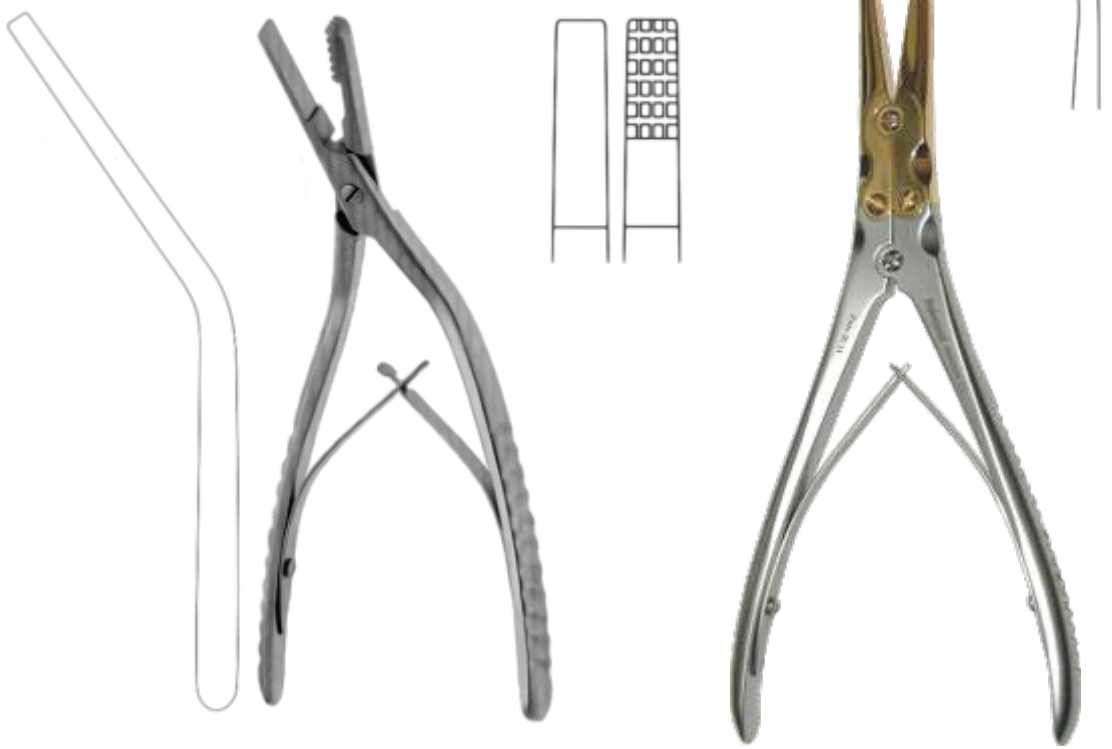

OBWEGESER
PAN-29.23
18.5 cm / 7¼"

OBWEGESER
PAN-30.34
21 cm / 8¼"



Liposuction Cannula
& Accessories

Liposuction Cannula

Syringes Connections



60cc smart hub



30cc Smart Hub

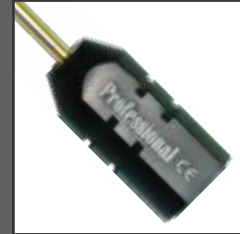

Super Luer lock



Luer lock



Luer lock
(Stainless Steel)

Machine Connections

Power Handle

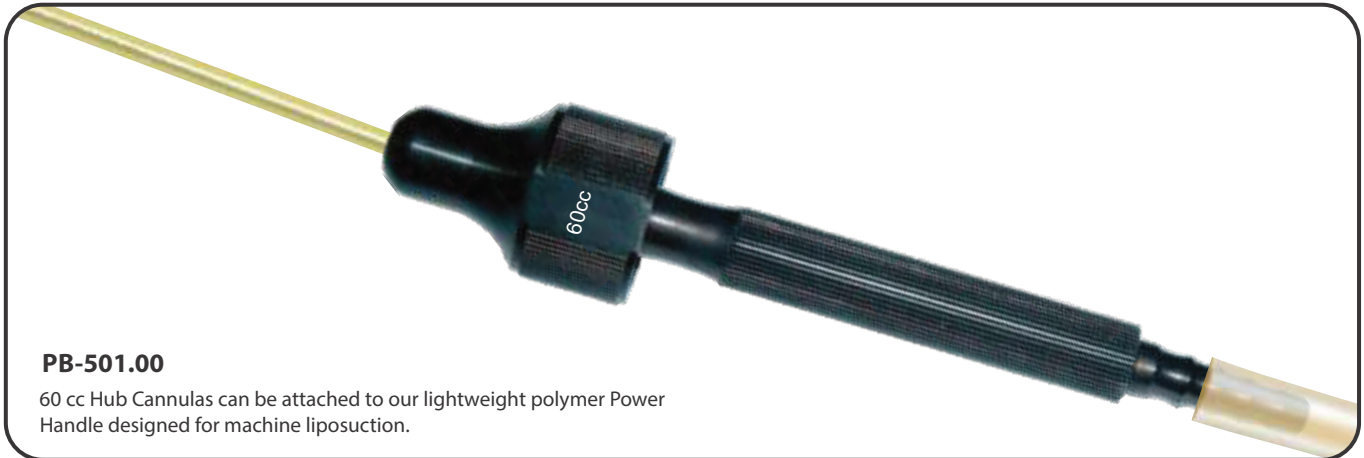

PB-501.00

60 cc Hub Cannulas can be attached to our lightweight polymer Power Handle designed for machine liposuction.

A- Power Cannula



PB-500.00

Cannulas and Harvesters as a complete instrument ready to use with an aspiration machine for liposuction and large volume fat harvesting procedures.

Liposuction Cannula

B- Power Cannula

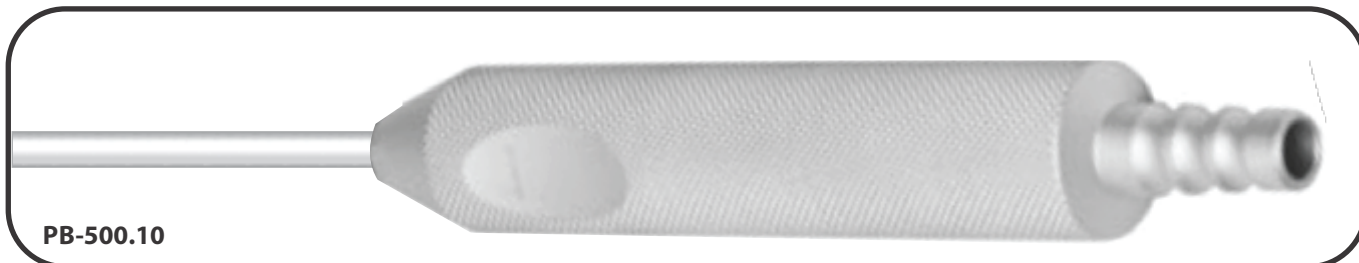

Adaptor Cannula



Adaptor Cannula

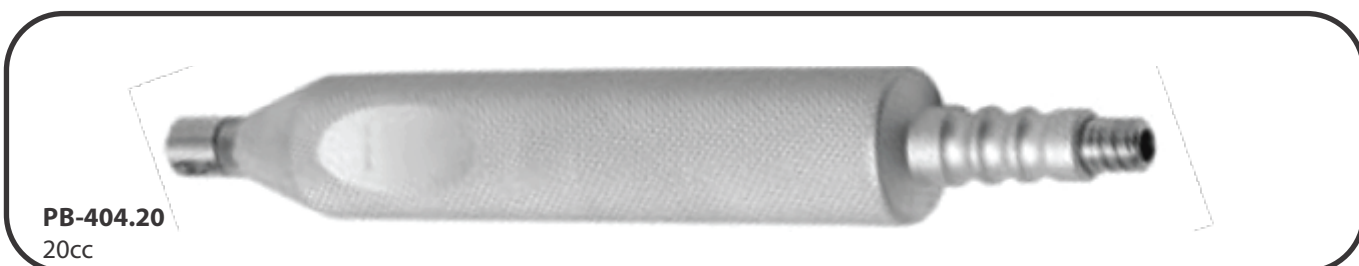

Adaptor Cannula

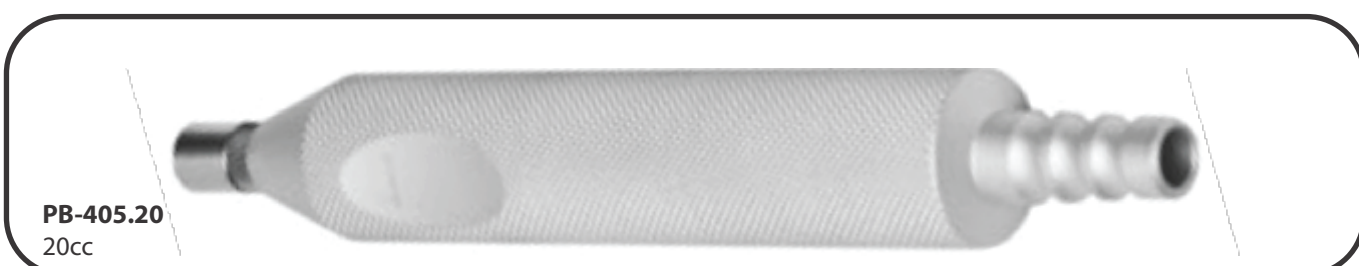

Liposuction Cannula

Infiltrators



Tumescent Infiltrator

This cannula is used specifically for the infusion of tumescent solution. The configuration of the ports allows even distribution of the fluid. **Also available in Power Cannulas of handle A & B.**

A- Power Cannula



B- Power Cannula



60cc smart hub

PB-502.05	2.50mm X 15 cm
PB-502.10	2.50mm X 20 cm
PB-502.20	3.00mm X 20 cm
PB-502.25	3.00mm X 25 cm

30 cc Smart Hub

PB-502.41	2.50mm X 15 cm
PB-502.45	2.50mm X 20 cm
PB-502.50	3.00mm X 20 cm
PB-502.55	3.00mm X 25 cm

Super Luer lock

PB-502.65	1.00mm X 5 cm
PB-502.67	1.20mm X 7 cm
PB-502.77	1.50mm X 7 cm
PB-502.79	1.50mm X 9 cm
PB-502.87	1.75mm X 7 cm
PB-502.89	1.75mm X 9 cm

Luer lock

PB-503.04	1.00mm X 4 cm
PB-503.05	1.00mm X 5 cm
PB-503.07	1.20mm X 7 cm
PB-503.08	1.50mm X 7 cm
PB-503.09	1.50mm X 9 cm
PB-503.17	1.75mm X 7 cm
PB-503.19	1.75mm X 9 cm
PB-503.20	1.75mm X 10 cm
PB-503.22	1.75mm X 12 cm
PB-503.24	2.00mm X 10 cm
PB-503.26	2.00mm X 12 cm
PB-503.28	2.00mm X 15 cm
PB-503.30	2.00mm X 20 cm
PB-503.32	2.50mm X 15 cm
PB-503.34	2.50mm X 20 cm
PB-503.36	3.00mm X 15 cm
PB-503.38	3.00mm X 20 cm

Luer lock (Stainless Steel)

PB-503.44	1.00mm X 4 cm
PB-503.45	1.00mm X 5 cm
PB-503.47	1.20mm X 7 cm
PB-503.48	1.50mm X 7 cm
PB-503.49	1.50mm X 9 cm
PB-503.51	1.75mm X 7 cm
PB-503.53	1.75mm X 9 cm
PB-503.55	1.75mm X 10 cm
PB-503.57	1.75mm X 12 cm
PB-503.60	2.00mm X 10 cm
PB-503.62	2.00mm X 12 cm
PB-503.65	2.00mm X 15 cm
PB-503.70	2.00mm X 20 cm
PB-503.75	2.50mm X 15 cm
PB-503.80	2.50mm X 20 cm
PB-503.85	3.00mm X 15 cm

Power Cannula

PB-504.05	2mm OD X 15 cm
PB-504.10	2mm OD X 20 cm
PB-504.15	2mm OD X 25 cm
PB-504.20	2mm OD X 30 cm
PB-504.25	2mm OD X 35 cm
PB-504.26	3mm OD X 15 cm
PB-504.30	3mm OD X 20 cm
PB-504.35	3mm OD X 25 cm
PB-504.40	3mm OD X 30 cm
PB-504.45	3mm OD X 35 cm
PB-504.46	4mm OD X 15 cm
PB-504.50	4mm OD X 20 cm
PB-504.55	4mm OD X 25 cm
PB-504.60	4mm OD X 30 cm
PB-504.65	4mm OD X 35 cm
PB-504.66	5mm OD X 15 cm
PB-504.70	5mm OD X 20 cm
PB-504.75	5mm OD X 25 cm
PB-504.80	5mm OD X 30 cm
PB-504.85	5mm OD X 35 cm
PB-504.86	6mm OD X 15 cm
PB-504.90	6mm OD X 20 cm
PB-504.95	6mm OD X 25 cm
PB-504.97	6mm OD X 30 cm
PB-504.98	6mm OD X 35 cm

60cc smart hub



30cc smart hub



Super Luer Lock



Luer Lock



Luer Lock
(Stainless Steel)



Liposuction Cannulas

Liposuction Cannula



Stevens Speed Cannula

(This Instrument only available in Power Cannulas of handle A & B.)

Power Cannula

PB-505.05	2.50mm X 15 cm
PB-505.10	2.50mm X 20 cm
PB-505.15	3.00mm X 15 cm
PB-505.20	3.00mm X 20 cm
PB-505.25	3.00mm X 25 cm
PB-505.26	3.75mm X 25 cm
PB-505.30	3.75mm X 30 cm
PB-505.35	3.75mm X 35 cm
PB-505.40	4.50mm X 30 cm
PB-505.45	4.50mm X 35 cm

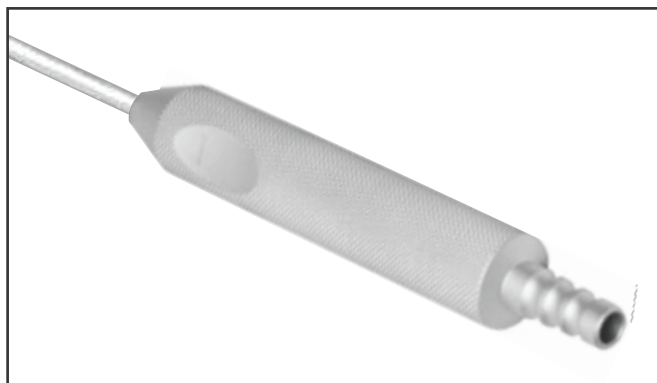

Cannulas and Harvesters as a complete instrument ready to use with an aspiration machine for liposuction and large volume fat harvesting procedures.

60cc smart hub



30cc smart hub



Super Luer Lock



Luer Lock



Luer Lock
(Stainless Steel)



Liposuction Cannula



Cobra Bibevel

More aggressive than the Standard, Pyramid or Mercedes, this cannula has a tapered tip with two ports and works effectively within dense fibrous tissue. **Also available in Power Cannulas of handle A & B.**

A- Power Cannula



B- Power Cannula



60cc smart hub

PB-506.05	2.50mm X 15 cm
PB-506.08	2.50mm X 20 cm
PB-506.10	3.00mm X 15 cm
PB-506.12	3.00mm X 20 cm
PB-506.14	3.00mm X 25 cm
PB-506.16	3.75mm X 25 cm
PB-506.18	3.75mm X 30 cm
PB-506.20	3.75mm X 35 cm
PB-506.22	4.50mm X 30 cm
PB-506.24	4.50mm X 35 cm

30 cc Smart Hub

PB-506.35	2.50mm X 15 cm
PB-506.37	2.50mm X 20 cm
PB-506.39	3.00mm X 15 cm
PB-506.40	3.00mm X 20 cm
PB-506.41	3.00mm X 25 cm
PB-506.42	3.75mm X 25 cm
PB-506.43	3.75mm X 30 cm
PB-506.44	3.75mm X 35 cm
PB-506.45	4.50mm X 30 cm
PB-506.46	4.50mm X 35 cm

Super Luer lock

PB-506.55	2.00mm X 15 cm
PB-506.57	2.50mm X 15 cm
PB-506.60	2.50mm X 20 cm
PB-506.62	3.00mm X 15 cm
PB-506.64	3.00mm X 20 cm
PB-506.65	3.00mm X 25 cm

Luer lock

PB-507.05	2.00mm X 15 cm
PB-507.07	2.50mm X 15 cm
PB-507.09	2.50mm X 20 cm
PB-507.15	3.00mm X 15 cm
PB-507.20	3.00mm X 20 cm
PB-507.25	3.00mm X 25 cm

Luer lock (Stainless Steel)

PB-507.35	2.00mm X 15 cm
PB-507.36	2.50mm X 15 cm
PB-507.38	2.50mm X 20 cm
PB-507.40	3.00mm X 15 cm
PB-507.42	3.00mm X 20 cm
PB-507.44	3.00mm X 25 cm

Power Cannula

PB-507.50	2mm OD X 15 cm
PB-507.52	2mm OD X 20 cm
PB-507.54	2mm OD X 25 cm
PB-507.55	2mm OD X 30 cm
PB-507.56	2mm OD X 35 cm
PB-507.57	3mm OD X 15 cm
PB-507.60	3mm OD X 20 cm
PB-507.62	3mm OD X 25 cm
PB-507.64	3mm OD X 30 cm
PB-507.65	3mm OD X 35 cm
PB-507.66	4mm OD X 15 cm
PB-507.68	4mm OD X 20 cm
PB-507.70	4mm OD X 25 cm
PB-507.72	4mm OD X 30 cm
PB-507.74	4mm OD X 35 cm
PB-507.75	5mm OD X 15 cm
PB-507.77	5mm OD X 20 cm
PB-507.79	5mm OD X 25 cm
PB-507.80	5mm OD X 30 cm
PB-507.82	5mm OD X 35 cm
PB-507.84	6mm OD X 15 cm
PB-507.86	6mm OD X 20 cm
PB-507.88	6mm OD X 25 cm
PB-507.90	6mm OD X 30 cm
PB-507.95	6mm OD X 35 cm

60cc smart hub 30cc smart hub Super Luer Lock Luer Lock Luer Lock (Stainless Steel)



Liposuction Cannulas

Liposuction Cannula



Cobra Round Tip

Less aggressive than the Cobra Bibevel this cell friendly cannula has a rounded tip with two ports and works effectively within dense fibrous tissue during liposuction procedures. **Also available in Power Cannulas of handle A & B.**

A- Power Cannula



B- Power Cannula



60cc smart hub

PB-508.01	2.50mm X 15 cm
PB-508.03	2.50mm X 20 cm
PB-508.05	3.00mm X 15 cm
PB-508.07	3.00mm X 20 cm
PB-508.09	3.00mm X 25 cm
PB-508.11	3.75mm X 25 cm
PB-508.13	3.75mm X 30 cm
PB-508.15	3.75mm X 35 cm
PB-508.16	4.50mm X 30 cm
PB-508.17	4.50mm X 35 cm

30 cc Smart Hub

PB-508.25	2.50mm X 15 cm
PB-508.27	2.50mm X 20 cm
PB-508.28	3.00mm X 15 cm
PB-508.30	3.00mm X 20 cm
PB-508.32	3.00mm X 25 cm
PB-508.34	3.75mm X 25 cm
PB-508.36	3.75mm X 30 cm
PB-508.38	3.75mm X 35 cm
PB-508.40	4.50mm X 30 cm
PB-508.45	4.50mm X 35 cm

Super Luer lock

PB-508.50	2.00mm X 15 cm
PB-508.52	2.50mm X 15 cm
PB-508.54	2.50mm X 20 cm
PB-508.56	3.00mm X 15 cm
PB-508.58	3.00mm X 20 cm
PB-508.60	3.00mm X 25 cm

Luer lock

PB-508.65	2.00mm X 15 cm
PB-508.67	2.50mm X 15 cm
PB-508.69	2.50mm X 20 cm
PB-508.71	3.00mm X 15 cm
PB-508.73	3.00mm X 20 cm
PB-508.75	3.00mm X 25 cm

Luer lock (Stainless Steel)

PB-508.85	2.00mm X 15 cm
PB-508.87	2.50mm X 15 cm
PB-508.89	2.50mm X 20 cm
PB-508.90	3.00mm X 15 cm
PB-508.92	3.00mm X 20 cm
PB-508.95	3.00mm X 25 cm

Power Cannula

PB-509.15	2mm OD X 15 cm
PB-509.17	2mm OD X 20 cm
PB-509.19	2mm OD X 25 cm
PB-509.20	2mm OD X 30 cm
PB-509.22	2mm OD X 35 cm
PB-509.25	3mm OD X 15 cm
PB-509.27	3mm OD X 20 cm
PB-509.29	3mm OD X 25 cm
PB-509.30	3mm OD X 30 cm
PB-509.32	3mm OD X 35 cm
PB-509.35	4mm OD X 15 cm
PB-509.37	4mm OD X 20 cm
PB-509.39	4mm OD X 25 cm
PB-509.40	4mm OD X 30 cm
PB-509.42	4mm OD X 35 cm
PB-509.45	5mm OD X 15 cm
PB-509.47	5mm OD X 20 cm
PB-509.49	5mm OD X 25 cm
PB-509.50	5mm OD X 30 cm
PB-509.52	5mm OD X 35 cm
PB-509.55	6mm OD X 15 cm
PB-509.57	6mm OD X 20 cm
PB-509.59	6mm OD X 25 cm
PB-509.60	6mm OD X 30 cm
PB-509.65	6mm OD X 35 cm

60cc smart hub 30cc smart hub Super Luer Lock Luer Lock Luer Lock (Stainless Steel)



Liposuction Cannula

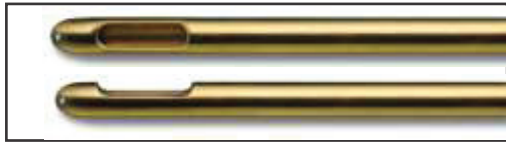

A- Power Cannula



B- Power Cannula

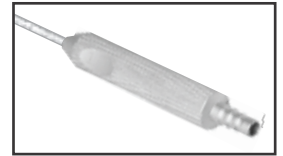

Standard, Fig. 1B

This is the most common cell friendly cannula design for soft tissue removal. The single port is located 180 degrees from the thumb rest on the hub. **Also available in Power Cannulas of handle A & B.**

60cc smart hub

PB-510.01	2.50mm X 15 cm
PB-510.03	2.50mm X 20 cm
PB-510.05	3.00mm X 15 cm
PB-510.07	3.00mm X 20 cm
PB-510.09	3.00mm X 25 cm
PB-510.10	3.75mm X 25 cm
PB-510.12	3.75mm X 30 cm
PB-510.14	3.75mm X 35 cm
PB-510.16	4.50mm X 30 cm
PB-510.18	4.50mm X 35 cm

30 cc Smart Hub

PB-510.25	2.50mm X 15 cm
PB-510.27	2.50mm X 20 cm
PB-510.29	3.00mm X 15 cm
PB-510.31	3.00mm X 20 cm
PB-510.33	3.00mm X 25 cm
PB-510.35	3.75mm X 25 cm
PB-510.37	3.75mm X 30 cm
PB-510.39	3.75mm X 35 cm
PB-510.41	4.50mm X 30 cm
PB-510.43	4.50mm X 35 cm

Super Luer lock

PB-510.45	1.75mm X 12 cm
PB-510.47	2.00mm X 15 cm
PB-510.49	2.00mm X 20 cm
PB-510.51	2.50mm X 15 cm
PB-510.53	2.50mm X 20 cm
PB-510.55	3.00mm X 15 cm
PB-510.57	3.00mm X 20 cm
PB-510.59	3.00mm X 25 cm

Luer lock

PB-510.62	1.75 mm X 12 cm
PB-510.64	2.00mm X 15 cm
PB-510.66	2.00mm X 20 cm
PB-510.68	2.50mm X 15 cm
PB-510.70	2.50mm X 20 cm
PB-510.72	3.00mm X 15 cm
PB-510.74	3.00mm X 20 cm
PB-510.75	3.00mm X 25 cm

Luer lock (Stainless Steel)

PB-510.82	1.75mm X 12 cm
PB-510.84	2.00mm X 15 cm
PB-510.86	2.00mm X 20 cm
PB-510.88	2.50mm X 15 cm
PB-510.90	2.50mm X 20 cm
PB-510.92	3.00mm X 15 cm
PB-510.94	3.00mm X 20 cm
PB-510.95	3.00mm X 25 cm

Power Cannula

PB-511.05	2mm OD X 15 cm
PB-511.10	2mm OD X 20 cm
PB-511.12	2mm OD X 25 cm
PB-511.14	2mm OD X 30 cm
PB-511.15	2mm OD X 35 cm
PB-511.17	3mm OD X 15 cm
PB-511.20	3mm OD X 20 cm
PB-511.25	3mm OD X 25 cm
PB-511.27	3mm OD X 30 cm
PB-511.30	3mm OD X 35 cm
PB-511.35	4mm OD X 15 cm
PB-511.37	4mm OD X 20 cm
PB-511.40	4mm OD X 25 cm
PB-511.42	4mm OD X 30 cm
PB-511.45	4mm OD X 35 cm
PB-511.47	5mm OD X 15 cm
PB-511.50	5mm OD X 20 cm
PB-511.52	5mm OD X 25 cm
PB-511.55	5mm OD X 30 cm
PB-511.57	5mm OD X 35 cm
PB-511.60	6mm OD X 15 cm
PB-511.62	6mm OD X 20 cm
PB-511.65	6mm OD X 25 cm
PB-511.70	6mm OD X 30 cm
PB-511.75	6mm OD X 35 cm

60cc smart hub 30cc smart hub Super Luer Lock Luer Lock Luer Lock (Stainless Steel)



Liposuction Cannulas

Liposuction Cannula

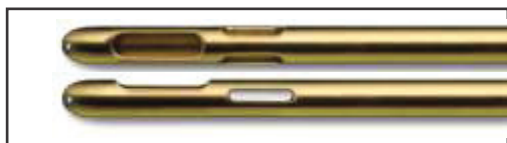

A- Power Cannula



B- Power Cannula



Pyramid

This commonly used design has three ports located 180 degrees from the thumb print. It is a slightly more aggressive cannula than the Standard during liposuction procedures. Also available in Power Cannulas of handle A & B.

60cc smart hub

PB-512.01	2.50mm X 15 cm
PB-512.03	2.50mm X 20 cm
PB-512.05	3.00mm X 15 cm
PB-512.07	3.00mm X 20 cm
PB-512.10	3.00mm X 25 cm
PB-512.12	3.75mm X 25 cm
PB-512.14	3.75mm X 30 cm
PB-512.16	3.75mm X 35 cm
PB-512.18	4.50mm X 30 cm
PB-512.20	4.50mm X 35 cm

30 cc Smart Hub

PB-512.25	2.50mm X 15 cm
PB-512.27	2.50mm X 20 cm
PB-512.29	3.00mm X 15 cm
PB-512.30	3.00mm X 20 cm
PB-512.32	3.00mm X 25 cm
PB-512.34	3.75mm X 25 cm
PB-512.36	3.75mm X 30 cm
PB-512.38	3.75mm X 35 cm
PB-512.40	4.50mm X 35 cm
PB-512.45	4.50mm X 35 cm

Super Luer lock

PB-512.52	1.75mm X 12 cm
PB-512.55	2.00mm X 15 cm
PB-512.57	2.50mm X 15 cm
PB-512.59	2.50mm X 20 cm
PB-512.62	3.00mm X 15 cm
PB-512.64	3.00mm X 20 cm
PB-512.65	3.00mm X 25 cm

Luer lock

PB-512.72	1.75mm X 12 cm
PB-512.74	2.00mm X 15 cm
PB-512.76	2.50mm X 15 cm
PB-512.78	2.50mm X 20 cm
PB-512.80	3.00mm X 15 cm
PB-512.82	3.00mm X 20 cm
PB-512.85	3.00mm X 25 cm

Luer lock (Stainless Steel)

PB-513.02	1.75mm X 12 cm
PB-513.05	2.00mm X 15 cm
PB-513.07	2.50mm X 15 cm
PB-513.09	2.50mm X 20 cm
PB-513.10	3.00mm X 15 cm
PB-513.12	3.00mm X 20 cm
PB-513.15	3.00mm X 25 cm

Power Cannula

PB-513.25	2mm OD X 15 cm
PB-513.27	2mm OD X 20 cm
PB-513.29	2mm OD X 25 cm
PB-513.30	2mm OD X 30 cm
PB-513.35	2mm OD X 35 cm
PB-513.36	3mm OD X 15 cm
PB-513.38	3mm OD X 20 cm
PB-513.40	3mm OD X 25 cm
PB-513.42	3mm OD X 30 cm
PB-513.44	3mm OD X 35 cm
PB-513.45	4mm OD X 15 cm
PB-513.47	4mm OD X 20 cm
PB-513.49	4mm OD X 25 cm
PB-513.50	4mm OD X 30 cm
PB-513.52	4mm OD X 35 cm
PB-513.53	5mm OD X 15 cm
PB-513.55	5mm OD X 20 cm
PB-513.57	5mm OD X 25 cm
PB-513.60	5mm OD X 30 cm
PB-513.62	5mm OD X 35 cm
PB-513.65	6mm OD X 15 cm
PB-513.67	6mm OD X 20 cm
PB-513.69	6mm OD X 25 cm
PB-513.70	6mm OD X 30 cm
PB-513.75	6mm OD X 35 cm

60cc smart hub



30cc smart hub



Super Luer Lock



Luer Lock



Luer Lock
(Stainless Steel)



Liposuction Cannula

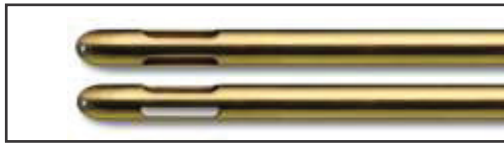

Mercedes

This circumferential three port configuration cell friendly liposuction cannula is effective for multi-plane soft tissue harvesting. Also available in Power Cannulas of handle A & B.

A- Power Cannula



B- Power Cannula



60cc smart hub

PB-514.01	2.50mm X 15 cm
PB-514.03	2.50mm X 20 cm
PB-514.05	3.00mm X 15 cm
PB-514.07	3.00mm X 20 cm
PB-514.09	3.00mm X 25 cm
PB-514.10	3.75mm X 25 cm
PB-514.15	3.75mm X 30 cm
PB-514.17	3.75mm X 35 cm
PB-514.19	4.50mm X 30 cm
PB-514.20	4.50mm X 35 cm

30 cc Smart Hub

PB-514.25	2.50mm X 15 cm
PB-514.27	2.50mm X 20 cm
PB-514.29	3.00mm X 15 cm
PB-514.30	3.00mm X 20 cm
PB-514.32	3.00mm X 25 cm
PB-514.34	3.75mm X 25 cm
PB-514.36	3.75mm X 30 cm
PB-514.38	3.75mm X 35 cm
PB-514.40	4.50mm X 30 cm
PB-514.45	4.50mm X 35 cm

Super Luer lock

PB-514.55	2.00mm X 15 cm
PB-514.57	2.50mm X 15 cm
PB-514.59	2.50mm X 20 cm
PB-514.60	3.00mm X 15 cm
PB-514.62	3.00mm X 20 cm
PB-514.65	3.00mm X 25 cm

Luer lock

PB-514.75	2.00mm X 15 cm
PB-514.77	2.50mm X 15 cm
PB-514.79	2.50mm X 20 cm
PB-514.85	3.00mm X 15 cm
PB-514.87	3.00mm X 20 cm
PB-514.90	3.00mm X 25 cm

Luer lock (Stainless Steel)

PB-515.05	2.00mm X 15 cm
PB-515.07	2.50mm X 15 cm
PB-515.10	2.50mm X 20 cm
PB-515.15	3.00mm X 15 cm
PB-515.17	3.00mm X 20 cm
PB-515.20	3.00mm X 25 cm

Power Cannula

PB-515.25	2mm OD X 15 cm
PB-515.27	2mm OD X 20 cm
PB-515.29	2mm OD X 25 cm
PB-515.30	2mm OD X 30 cm
PB-515.32	2mm OD X 35 cm
PB-515.34	3mm OD X 15 cm
PB-515.36	3mm OD X 20 cm
PB-515.38	3mm OD X 25 cm
PB-515.40	3mm OD X 30 cm
PB-515.42	3mm OD X 35 cm
PB-515.45	4mm OD X 15 cm
PB-515.47	4mm OD X 20 cm
PB-515.50	4mm OD X 25 cm
PB-515.53	4mm OD X 30 cm
PB-515.55	4mm OD X 35 cm
PB-515.57	5mm OD X 15 cm
PB-515.60	5mm OD X 20 cm
PB-515.65	5mm OD X 25 cm
PB-515.68	5mm OD X 30 cm
PB-515.70	5mm OD X 35 cm
PB-515.75	6mm OD X 15 cm
PB-515.77	6mm OD X 20 cm
PB-515.79	6mm OD X 25 cm
PB-515.80	6mm OD X 30 cm
PB-515.85	6mm OD X 35 cm

60cc smart hub 30cc smart hub Super Luer Lock Luer Lock



Luer Lock (Stainless Steel)

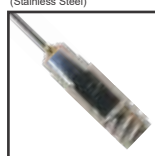

Liposuction Cannula

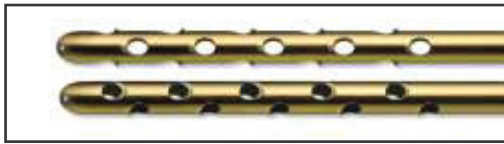

A- Power Cannula



B- Power Cannula



Tonnard Harvester

A multiport harvester with elevated 1mm microports which yield small enough aliquots of fat tissue to allow for easy and smooth injection with the Tulip 0.7, 0.9 and 1.2mm injectors. *Also available in Power Cannulas of handle A & B.*

60cc smart hub

PB-516.01	2.50mm X 15 cm
PB-516.03	2.50mm X 20 cm
PB-516.05	3.00mm X 15 cm
PB-516.07	3.00mm X 20 cm
PB-516.10	3.00mm X 25 cm
PB-516.12	3.75mm X 25 cm
PB-516.14	3.75mm X 30 cm
PB-516.16	3.75mm X 35 cm
PB-516.18	4.50mm X 30 cm
PB-516.20	4.50mm X 35 cm

30 cc Smart Hub

PB-516.25	2.50mm X 15 cm
PB-516.27	2.50mm X 20 cm
PB-516.29	3.00mm X 15 cm
PB-516.32	3.00mm X 20 cm
PB-516.34	3.00mm X 25 cm
PB-516.37	3.75mm X 25 cm
PB-516.39	3.75mm X 30 cm
PB-516.40	3.75mm X 35 cm
PB-516.42	4.50mm X 30 cm
PB-516.45	4.50mm X 35 cm

Super Luer lock

PB-516.55	2.00mm X 15 cm
PB-516.57	2.50mm X 15 cm
PB-516.60	2.50mm X 20 cm
PB-516.62	3.00mm X 15 cm
PB-516.64	3.00mm X 20 cm
PB-516.65	3.00mm X 25 cm

Luer lock

PB-516.75	2.00mm X 15 cm
PB-516.77	2.50mm X 15 cm
PB-516.79	2.50mm X 20 cm
PB-516.80	3.00mm X 15 cm
PB-516.82	3.00mm X 20 cm
PB-516.85	3.00mm X 25 cm

Luer lock (Stainless Steel)

PB-517.01	2.00mm X 15 cm
PB-517.03	2.50mm X 15 cm
PB-400.75	2.50mm X 20 cm
PB-517.07	3.00mm X 15 cm
PB-517.09	3.00mm X 20 cm
PB-400.76	3.00mm X 25 cm

Power Cannula

PB-517.15	2mm OD X 15 cm
PB-517.17	2mm OD X 20 cm
PB-517.19	2mm OD X 25 cm
PB-517.20	2mm OD X 30 cm
PB-517.22	2mm OD X 35 cm
PB-517.24	3mm OD X 15 cm
PB-517.26	3mm OD X 20 cm
PB-517.28	3mm OD X 25 cm
PB-517.30	3mm OD X 30 cm
PB-517.35	3mm OD X 35 cm
PB-517.45	4mm OD X 15 cm
PB-517.47	4mm OD X 20 cm
PB-517.49	4mm OD X 25 cm
PB-517.50	4mm OD X 30 cm
PB-517.55	4mm OD X 35 cm
PB-517.57	5mm OD X 15 cm
PB-517.60	5mm OD X 20 cm
PB-517.62	5mm OD X 25 cm
PB-517.65	5mm OD X 30 cm
PB-517.70	5mm OD X 35 cm
PB-517.75	6mm OD X 15 cm
PB-517.77	6mm OD X 20 cm
PB-517.79	6mm OD X 25 cm
PB-517.80	6mm OD X 30 cm
PB-517.85	6mm OD X 35 cm

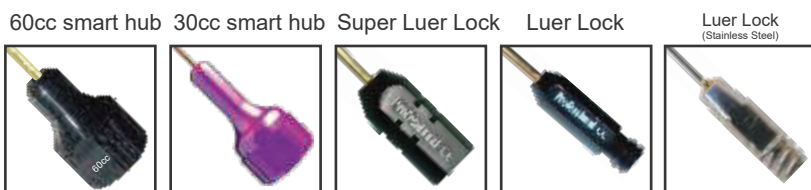

Liposuction Cannula



A- Power Cannula



B- Power Cannula



Sorensen Harvester

A sophisticated, precision-designed harvester that is truly Patient Friendly. The ports in the Sorensen Harvester are machined with alternating 60 degree cutting edges. This unique design is less traumatic than other multi-port harvesters and delivers a fine-grained, high fat content/purity yield that can easily pass through 1.2mm, 0.9mm and 0.7mm blunt injectors.

Also available in Power Cannulas of handle A & B.

60cc smart hub

PB-518.01	2.50mm X 15 cm
PB-518.03	2.50mm X 20 cm
PB-518.06	3.00mm X 20 cm
PB-518.09	3.00mm X 25 cm

30 cc Smart Hub

PB-518.15	2.50mm X 15 cm
PB-518.17	2.50mm X 20 cm
PB-518.19	3.00mm X 20 cm
PB-518.20	3.00mm X 25 cm

Super Luer lock

PB-518.25	2.50mm X 15 cm
PB-518.27	2.50mm X 20 cm
PB-518.29	3.00mm X 15 cm
PB-518.30	3.00mm X 20 cm
PB-518.35	3.00mm X 25 cm

Luer lock

PB-518.45	2.50mm X 15 cm
PB-518.47	2.50mm X 20 cm
PB-518.50	3.00mm X 15 cm
PB-518.55	3.00mm X 20 cm
PB-518.57	3.00mm X 25 cm

Luer lock (Stainless Steel)

PB-518.75	2.50mm X 15 cm
PB-400.55	2.50mm X 20 cm
PB-518.85	3.00mm X 15 cm
PB-518.90	3.00mm X 20 cm
PB-400.56	3.00mm X 25 cm

Power Cannula

PB-519.01	2mm OD X 15 cm
PB-519.03	2mm OD X 20 cm
PB-519.05	2mm OD X 25 cm
PB-519.07	2mm OD X 30 cm
PB-519.10	2mm OD X 35 cm
PB-519.15	3mm OD X 15 cm
PB-519.17	3mm OD X 20 cm
PB-519.20	3mm OD X 25 cm
PB-519.22	3mm OD X 30 cm
PB-519.25	3mm OD X 35 cm
PB-519.27	4mm OD X 15 cm
PB-519.30	4mm OD X 20 cm
PB-519.32	4mm OD X 25 cm
PB-519.35	4mm OD X 30 cm
PB-519.37	4mm OD X 35 cm
PB-519.40	5mm OD X 15 cm
PB-519.42	5mm OD X 20 cm
PB-519.45	5mm OD X 25 cm
PB-519.47	5mm OD X 30 cm
PB-519.50	5mm OD X 35 cm
PB-519.52	6mm OD X 15 cm
PB-519.55	6mm OD X 20 cm
PB-519.57	6mm OD X 25 cm
PB-519.60	6mm OD X 30 cm
PB-519.65	6mm OD X 35 cm

60cc smart hub



30cc smart hub



Super Luer Lock



Luer Lock



Luer Lock
(Stainless Steel)

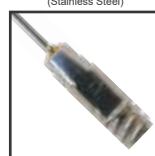

Liposuction Cannulas

Liposuction Cannula



A- Power Cannula



B- Power Cannula



Miller Speed Harvester

NEW! Exclusively from Tulip - Six port spiral configuration on this CellFriendly liposuction cannula harvests maximum tissue volume in minimal time. Also available in Power Cannulas of handle A & B.

60cc smart hub

PB-520.01	2.50mm X 15 cm
PB-520.03	2.50mm X 20 cm
PB-520.05	3.00mm X 15 cm
PB-520.07	3.00mm X 25 cm
PB-520.10	3.75mm X 25 cm

30 cc Smart Hub

PB-520.15	2.50mm X 15 cm
PB-520.17	2.50mm X 20 cm
PB-520.20	3.00mm X 15 cm
PB-520.25	3.00mm X 25 cm
PB-520.35	3.75mm X 25 cm

Super Luer lock

PB-520.45	2.50mm X 15 cm
PB-520.47	3.00mm X 15 cm
PB-520.50	3.00mm X 25 cm
PB-520.55	3.75mm X 15 cm
PB-520.60	3.75mm X 25 cm

Luer lock

PB-520.65	2.50mm X 15 cm
PB-520.67	3.00mm X 15 cm
PB-520.70	3.00mm X 25 cm
PB-520.75	3.75mm X 15 cm
PB-520.80	3.75mm X 25 cm

Luer lock (Stainless Steel)

PB-520.85	2.50mm X 15 cm
PB-520.87	3.00mm X 15 cm
PB-520.90	3.00mm X 25 cm
PB-520.92	3.75mm X 15 cm
PB-520.95	3.75mm X 25 cm

Power Cannula

PB-521.05	2mm OD X 15 cm
PB-521.07	2mm OD X 20 cm
PB-521.10	2mm OD X 25 cm
PB-521.12	2mm OD X 30 cm
PB-521.15	2mm OD X 35 cm
PB-521.17	3mm OD X 15 cm
PB-521.20	3mm OD X 20 cm
PB-521.22	3mm OD X 25 cm
PB-521.25	3mm OD X 30 cm
PB-521.30	3mm OD X 35 cm
PB-521.35	4mm OD X 15 cm
PB-521.37	4mm OD X 20 cm
PB-521.40	4mm OD X 25 cm
PB-521.42	4mm OD X 30 cm
PB-521.45	4mm OD X 35 cm
PB-521.50	5mm OD X 15 cm
PB-521.52	5mm OD X 20 cm
PB-521.55	5mm OD X 25 cm
PB-521.57	5mm OD X 30 cm
PB-521.60	5mm OD X 35 cm
PB-521.65	6mm OD X 15 cm
PB-521.67	6mm OD X 20 cm
PB-521.70	6mm OD X 25 cm
PB-521.72	6mm OD X 30 cm
PB-521.75	6mm OD X 35 cm

60cc smart hub



30cc smart hub



Super Luer Lock



Luer Lock



Luer Lock
(Stainless Steel)



Liposuction Cannula



Carraway Harvester

Spiral three port design on this Cell Friendly liposuction cannula is effective for multi-plane adipose tissue harvesting.

Also available in Power Cannulas of handle A & B.

A- Power Cannula



B- Power Cannula



60cc smart hub

PB-522.01	2.50mm X 15 cm
PB-522.03	2.50mm X 20 cm
PB-522.05	3.00mm X 15 cm
PB-522.07	3.00mm X 20 cm
PB-522.10	3.00mm X 25 cm
PB-522.12	3.75mm X 25 cm
PB-522.15	3.75mm X 30 cm
PB-522.17	3.75mm X 35 cm
PB-522.20	4.50mm X 30 cm
PB-522.25	4.50mm X 35 cm

Luer lock (Stainless Steel)

PB-523.01	1.75mm X 10 cm
PB-523.03	1.75mm X 12 cm
PB-523.05	2.00mm X 10 cm
PB-523.07	2.00mm X 15 cm
PB-523.10	2.50mm X 20 cm
PB-523.12	3.00mm X 15 cm
PB-523.15	3.00mm X 20 cm
PB-523.20	3.00mm X 25 cm

30 cc Smart Hub

PB-522.35	2.50mm X 15 cm
PB-522.37	2.50mm X 20 cm
PB-522.40	3.00mm X 15 cm
PB-522.42	3.00mm X 20 cm
PB-522.45	3.00mm X 25 cm
PB-522.47	3.75mm X 25 cm
PB-522.50	3.75mm X 30 cm
PB-522.52	3.75mm X 35 cm
PB-522.55	4.50mm X 30 cm
PB-522.57	4.50mm X 35 cm

Power Cannula

PB-523.25	2mm OD X 15 cm
PB-523.27	2mm OD X 20 cm
PB-523.30	2mm OD X 25 cm
PB-523.32	2mm OD X 30 cm
PB-523.35	2mm OD X 35 cm
PB-523.37	3mm OD X 15 cm
PB-523.40	3mm OD X 20 cm
PB-523.42	3mm OD X 25 cm
PB-523.45	3mm OD X 30 cm
PB-523.47	3mm OD X 35 cm
PB-523.50	4mm OD X 15 cm
PB-523.52	4mm OD X 20 cm
PB-523.55	4mm OD X 25 cm
PB-523.57	4mm OD X 30 cm
PB-523.60	4mm OD X 35 cm
PB-523.62	5mm OD X 15 cm
PB-523.65	5mm OD X 20 cm
PB-523.67	5mm OD X 25 cm
PB-523.70	5mm OD X 30 cm
PB-523.72	5mm OD X 35 cm
PB-523.75	6mm OD X 15 cm
PB-523.77	6mm OD X 20 cm
PB-523.80	6mm OD X 25 cm
PB-523.82	6mm OD X 30 cm
PB-523.85	6mm OD X 35 cm

Super Luer lock

PB-522.60	1.75mm X 10 cm
PB-522.62	1.75mm X 12 cm
PB-522.64	2.00mm X 10 cm
PB-522.66	2.00mm X 15 cm
PB-522.68	2.50mm X 20 cm
PB-522.70	3.00mm X 15 cm
PB-522.72	3.00mm X 20 cm
PB-522.75	3.00mm X 25 cm

Luer lock

PB-522.80	1.75mm X 10 cm
PB-522.82	1.75mm X 12 cm
PB-522.84	2.00mm X 10 cm
PB-522.86	2.00mm X 15 cm
PB-522.88	2.50mm X 20 cm
PB-522.90	3.00mm X 15 cm
PB-522.92	3.00mm X 20 cm
PB-522.95	3.00mm X 25 cm

60cc smart hub 30cc smart hub Super Luer Lock Luer Lock Luer Lock (Stainless Steel)



Liposuction Cannulas

Liposuction Cannula

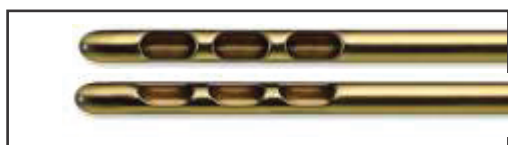

TriPort Harvester, Fig. 3B

This body sculpting instrument is excellent for harvesting small aliquots of tissue during liposuction procedures
 Also available in Power Cannulas of handle A & B.

A- Power Cannula



B- Power Cannula



60cc smart hub

PB-524.01	2.50mm X 15 cm
PB-524.03	2.50mm X 20 cm
PB-524.05	3.00mm X 15 cm
PB-524.07	3.00mm X 20 cm
PB-524.10	3.00mm X 25 cm
PB-524.12	3.75mm X 25 cm
PB-524.15	3.75mm X 30 cm
PB-524.17	3.75mm X 35 cm
PB-524.20	4.50mm X 30 cm
PB-524.25	4.50mm X 35 cm

30 cc Smart Hub

PB-524.35	2.50mm X 15 cm
PB-524.37	2.50mm X 20 cm
PB-524.40	3.00mm X 15 cm
PB-524.42	3.00mm X 20 cm
PB-524.45	3.00mm X 25 cm
PB-524.47	3.75mm X 25 cm
PB-524.50	3.75mm X 30 cm
PB-524.52	3.75mm X 35 cm
PB-524.55	4.50mm X 30 cm
PB-524.57	4.50mm X 35 cm

Super Luer lock

PB-524.62	1.75mm X 12 cm
PB-524.64	2.00mm X 15 cm
PB-524.67	2.50mm X 15 cm
PB-524.70	2.50mm X 20 cm
PB-524.72	3.00mm X 15 cm
PB-524.75	3.00mm X 20 cm
PB-524.80	3.00mm X 25 cm

Luer lock

PB-524.82	1.75mm X 12 cm
PB-524.84	2.00mm X 15 cm
PB-524.86	2.50mm X 15 cm
PB-524.88	2.50mm X 20 cm
PB-524.90	3.00mm X 15 cm
PB-524.92	3.00mm X 20 cm
PB-524.95	3.00mm X 25 cm

Luer lock (Stainless Steel)

PB-525.02	1.75mm X 12 cm
PB-525.05	2.00mm X 15 cm
PB-400.26	2.50mm X 15 cm
PB-400.25	2.50mm X 20 cm
PB-400.32	3.00mm X 15 cm
PB-525.15	3.00mm X 20 cm
PB-525.20	3.00mm X 25 cm

Power Cannula

PB-525.25	2mm OD X 15 cm
PB-525.27	2mm OD X 20 cm
PB-525.30	2mm OD X 25 cm
PB-525.32	2mm OD X 30 cm
PB-525.35	2mm OD X 35 cm
PB-525.37	3mm OD X 15 cm
PB-525.40	3mm OD X 20 cm
PB-525.42	3mm OD X 25 cm
PB-525.45	3mm OD X 30 cm
PB-525.47	3mm OD X 35 cm
PB-525.50	4mm OD X 15 cm
PB-525.52	4mm OD X 20 cm
PB-525.55	4mm OD X 25 cm
PB-525.57	4mm OD X 30 cm
PB-525.60	4mm OD X 35 cm
PB-525.65	5mm OD X 15 cm
PB-525.67	5mm OD X 20 cm
PB-525.70	5mm OD X 25 cm
PB-525.72	5mm OD X 30 cm
PB-525.75	5mm OD X 35 cm
PB-525.77	6mm OD X 15 cm
PB-525.80	6mm OD X 20 cm
PB-525.85	6mm OD X 25 cm
PB-525.87	6mm OD X 30 cm
PB-525.90	6mm OD X 35 cm

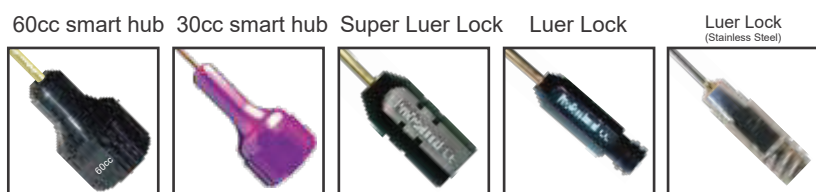

Liposuction Cannula



A- Power Cannula



B- Power Cannula



Flap

The Flap is primarily used as an undermining dissector, and in smaller diameters, for facial tissue removal. The Flap Cannula in a 2.1mm diameter is very useful for undermining the nasolabial fold prior to autologous tissue injections, as well as for tissue removal in this anatomic area. **Also available in Power Cannulas of handle A & B.**

60cc smart hub

PB-526.01	2.50mm X 15 cm
PB-526.03	2.50mm X 20 cm
PB-526.05	3.00mm X 15 cm
PB-526.07	3.00mm X 20 cm
PB-526.10	3.00mm X 25 cm
PB-526.12	3.75mm X 25 cm
PB-526.15	3.75mm X 30 cm
PB-526.20	3.75mm X 35 cm

Luer lock (Stainless Steel)

PB-527.01	1.75mm X 10 cm
PB-527.02	1.75mm X 12 cm
PB-527.05	2.00mm X 10 cm
PB-527.07	2.00mm X 15 cm
PB-527.10	2.50mm X 20 cm
PB-527.12	3.00mm X 15 cm
PB-527.15	3.00mm X 20 cm
PB-527.20	3.00mm X 25 cm

30 cc Smart Hub

PB-526.25	2.50mm X 15 cm
PB-526.27	2.50mm X 20 cm
PB-526.30	3.00mm X 15 cm
PB-526.32	3.00mm X 20 cm
PB-526.34	3.00mm X 25 cm
PB-526.36	3.75mm X 25 cm
PB-526.38	3.75mm X 30 cm
PB-526.40	3.75mm X 35 cm

Power Cannula

PB-527.25	2mm OD X 15 cm
PB-527.27	2mm OD X 20 cm
PB-527.30	2mm OD X 25 cm
PB-527.32	2mm OD X 30 cm
PB-527.35	2mm OD X 35 cm
PB-527.37	3mm OD X 15 cm
PB-527.38	3mm OD X 20 cm
PB-527.42	3mm OD X 25 cm
PB-527.45	3mm OD X 30 cm
PB-527.47	3mm OD X 35 cm
PB-527.50	4mm OD X 15 cm
PB-527.52	4mm OD X 20 cm
PB-527.54	4mm OD X 25 cm
PB-527.56	4mm OD X 30 cm
PB-527.58	4mm OD X 35 cm
PB-527.60	5mm OD X 15 cm
PB-527.62	5mm OD X 20 cm
PB-527.64	5mm OD X 25 cm
PB-527.66	5mm OD X 30 cm
PB-527.68	5mm OD X 35 cm
PB-527.70	6mm OD X 15 cm
PB-527.72	6mm OD X 20 cm
PB-527.74	6mm OD X 25 cm
PB-527.77	6mm OD X 30 cm
PB-527.80	6mm OD X 35 cm

Super Luer lock

PB-526.47	1.75mm X 7 cm
PB-526.50	2.00mm X 15 cm
PB-526.52	2.50mm X 15 cm
PB-526.54	2.50mm X 20 cm
PB-526.56	3.00mm X 15 cm
PB-526.58	3.00mm X 20 cm
PB-526.60	3.00mm X 25 cm

Luer lock

PB-526.77	1.75mm X 7 cm
PB-526.80	2.00mm X 15 cm
PB-526.82	2.50mm X 15 cm
PB-526.84	2.50mm X 20 cm
PB-526.86	3.00mm X 15 cm
PB-526.88	3.00mm X 20 cm
PB-526.90	3.00mm X 25 cm

60cc smart hub



30cc smart hub



Super Luer Lock



Luer Lock



Luer Lock
(Stainless Steel)

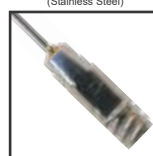

Liposuction Cannula

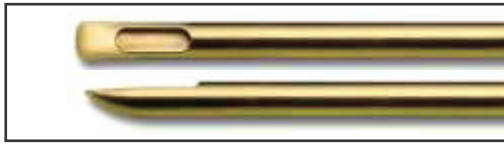

A- Power Cannula



B- Power Cannula



Field Flap

With its elevated leading edge, this cannula is designed to open and expose soft tissue for more precise suctioning along the mandible and sub-mental areas. Also available in Power Cannulas of handle A & B.

60cc smart hub

PB-528.01	2.50mm X 15 cm
PB-528.03	2.50mm X 20 cm
PB-528.05	3.00mm X 15 cm
PB-528.07	3.00mm X 20 cm
PB-528.10	3.00mm X 25 cm
PB-528.12	3.75mm X 25 cm
PB-528.14	3.75mm X 30 cm
PB-528.16	3.75mm X 35 cm

30 cc Smart Hub

PB-528.25	2.50mm X 15 cm
PB-528.27	2.50mm X 20 cm
PB-528.30	3.00mm X 15 cm
PB-528.32	3.00mm X 20 cm
PB-528.35	3.00mm X 25 cm
PB-528.38	3.75mm X 25 cm
PB-528.40	3.75mm X 30 cm
PB-528.45	3.75mm X 35 cm

Super Luer lock

PB-528.51	1.75mm X 7 cm
PB-528.53	2.00mm X 15 cm
PB-528.55	2.50mm X 15 cm
PB-528.57	2.50mm X 20 cm
PB-528.60	3.00mm X 15 cm
PB-528.62	3.00mm X 20 cm
PB-528.65	3.00mm X 25 cm

Luer lock

PB-528.75	1.75mm X 7 cm
PB-528.77	2.00mm X 15 cm
PB-528.80	2.50mm X 15 cm
PB-528.82	2.50mm X 20 cm
PB-528.85	3.00mm X 15 cm
PB-528.88	3.00mm X 20 cm
PB-528.90	3.00mm X 25 cm

Luer lock (Stainless Steel)

PB-529.02	1.75mm X 12 cm
PB-529.05	2.00mm X 15 cm
PB-529.08	2.50mm X 15 cm
PB-529.10	2.50mm X 20 cm
PB-529.12	3.00mm X 15 cm
PB-529.15	3.00mm X 20 cm
PB-529.20	3.00mm X 25 cm

Power Cannula

PB-529.25	2mm OD X 15 cm
PB-529.27	2mm OD X 20 cm
PB-529.30	2mm OD X 25 cm
PB-529.32	2mm OD X 30 cm
PB-529.35	2mm OD X 35 cm
PB-529.37	3mm OD X 15 cm
PB-529.40	3mm OD X 20 cm
PB-529.42	3mm OD X 25 cm
PB-529.45	3mm OD X 30 cm
PB-529.47	3mm OD X 35 cm
PB-529.50	4mm OD X 15 cm
PB-529.52	4mm OD X 20 cm
PB-529.55	4mm OD X 25 cm
PB-529.57	4mm OD X 30 cm
PB-529.60	4mm OD X 35 cm
PB-529.62	5mm OD X 15 cm
PB-529.65	5mm OD X 20 cm
PB-529.67	5mm OD X 25 cm
PB-529.68	5mm OD X 30 cm
PB-529.72	5mm OD X 35 cm
PB-529.75	6mm OD X 15 cm
PB-529.78	6mm OD X 20 cm
PB-529.80	6mm OD X 25 cm
PB-529.85	6mm OD X 30 cm
PB-529.90	6mm OD X 35 cm

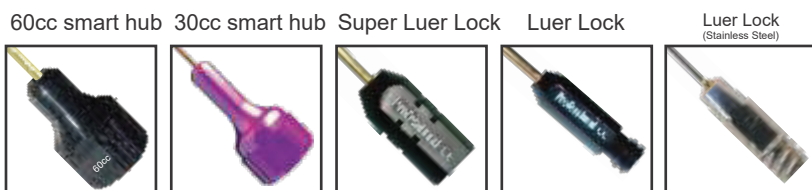

Liposuction Cannula



A- Power Cannula



B- Power Cannula



V-Dissector

This cannula is specifically designed for use in the superficial compartment of the truncal area. The cutting notch is very useful for undermining in facial procedures and in dense, fibrous tissue. **Also available in Power Cannulas of handle A & B.**

60cc smart hub

PB-530.01	2.50mm X 15 cm
PB-530.03	2.50mm X 20 cm
PB-530.05	3.00mm X 15 cm
PB-530.08	3.00mm X 20 cm
PB-530.10	3.00mm X 25 cm
PB-530.12	3.75mm X 25 cm
PB-530.14	3.75mm X 30 cm
PB-530.15	3.75mm X 35 cm

30 cc Smart Hub

PB-530.25	2.50mm X 15 cm
PB-530.27	2.50mm X 20 cm
PB-530.30	3.00mm X 15 cm
PB-530.32	3.00mm X 20 cm
PB-530.35	3.00mm X 25 cm
PB-530.37	3.75mm X 25 cm
PB-530.40	3.75mm X 30 cm
PB-530.45	3.75mm X 35 cm

Super Luer lock

PB-530.57	1.75mm X 7 cm
PB-530.60	2.00mm X 15 cm
PB-530.62	2.50mm X 15 cm
PB-530.64	2.50mm X 20 cm
PB-530.66	3.00mm X 15 cm
PB-530.68	3.00mm X 20 cm
PB-530.70	3.00mm X 25 cm

Luer lock

PB-530.77	1.75mm X 7 cm
PB-530.79	2.00mm X 15 cm
PB-530.81	2.50mm X 15 cm
PB-530.83	2.50mm X 20 cm
PB-530.85	3.00mm X 15 cm
PB-530.87	3.00mm X 20 cm
PB-530.90	3.00mm X 25 cm

Luer lock (Stainless Steel)

PB-531.01	1.75mm X 10 cm
PB-531.03	1.75mm X 12 cm
PB-531.05	2.00mm X 10 cm
PB-531.07	2.00mm X 15 cm
PB-531.10	2.50mm X 20 cm
PB-531.15	3.00mm X 15 cm
PB-531.17	3.00mm X 20 cm
PB-531.20	3.00mm X 25 cm

Power Cannula

PB-531.25	2mm OD X 15 cm
PB-531.27	2mm OD X 20 cm
PB-531.30	2mm OD X 25 cm
PB-531.32	2mm OD X 30 cm
PB-531.34	2mm OD X 35 cm
PB-531.35	3mm OD X 15 cm
PB-531.37	3mm OD X 20 cm
PB-531.40	3mm OD X 25 cm
PB-531.42	3mm OD X 30 cm
PB-531.45	3mm OD X 35 cm
PB-531.50	4mm OD X 15 cm
PB-531.52	4mm OD X 20 cm
PB-531.54	4mm OD X 25 cm
PB-531.57	4mm OD X 30 cm
PB-531.60	4mm OD X 35 cm
PB-531.62	5mm OD X 15 cm
PB-531.64	5mm OD X 20 cm
PB-531.66	5mm OD X 25 cm
PB-531.68	5mm OD X 30 cm
PB-531.70	5mm OD X 35 cm
PB-531.75	6mm OD X 15 cm
PB-531.77	6mm OD X 20 cm
PB-531.79	6mm OD X 25 cm
PB-531.80	6mm OD X 30 cm
PB-531.82	6mm OD X 35 cm

60cc smart hub



30cc smart hub



Super Luer Lock



Luer Lock



Luer Lock
(Stainless Steel)



Liposuction Cannulas

Liposuction Cannula



Basket Cannula

The Cell Friendly Basket Cannula is a versatile liposculpting tool. It can operate as an equalizer without vacuum to treat adipose tissue and skin irregularities in revision liposuction and fat transfer procedures. The Basket Cannula is also adept under vacuum as a fat harvesting cannula. For finishing, this cannula can be used as an injector for equalizing and adding adipose tissue to sculpt smoother contours.

A- Power Cannula



B- Power Cannula



available in Power Cannulas of handle A & B.

60cc smart hub

PB-532.01	3.00mm X 15 cm
PB-532.0	3.00mm X 20 cm
PB-532.05	3.00mm X 25 cm
PB-532.07	3.75mm X 25 cm
PB-532.10	3.75mm X 30 cm
PB-532.12	3.75mm X 35 cm



Infiltration Liposuction Cannula , 8 Holes
Fig. 3K

Luer lock (Stainless Steel)

	7cm	10cm	15cm	20cm	25cm	30cm
1.8Ø	PB-406.01	PB-406.07	PB-406.15	PB-406.29	PB-406.23	PB-406.36
2.0Ø	PB-406.02	PB-406.08	PB-406.16	PB-406.31	PB-406.24	PB-406.37
2.5Ø	PB-406.03	PB-406.09	PB-406.17	PB-406.19	PB-406.25	PB-406.30
3.0Ø	PB-406.04	PB-406.10	PB-406.18	PB-406.32	PB-406.26	PB-406.38
3.5Ø	PB-406.05	PB-406.11	PB-406.20	PB-406.33	PB-406.27	PB-406.39
4.0Ø	PB-406.06	PB-406.12	PB-406.21	PB-406.34	PB-406.28	PB-406.40

Power Cannula

PB-604.05	2mm OD X 15 cm	PB-604.35	3mm OD X 35 cm	PB-604.55	5mm OD X 25 cm
PB-604.07	2mm OD X 20 cm	PB-604.37	4mm OD X 15 cm	PB-604.57	5mm OD X 30 cm
PB-604.10	2mm OD X 25 cm	PB-604.40	4mm OD X 20 cm	PB-604.60	5mm OD X 35 cm
PB-604.12	2mm OD X 30 cm	PB-604.42	4mm OD X 25 cm	PB-604.62	6mm OD X 15 cm
PB-604.15	2mm OD X 35 cm	PB-604.45	4mm OD X 30 cm	PB-604.65	6mm OD X 20 cm
PB-604.20	3mm OD X 15 cm	PB-604.47	4mm OD X 35 cm	PB-604.67	6mm OD X 25 cm
PB-604.22	3mm OD X 20 cm	PB-604.50	5mm OD X 15 cm	PB-604.70	6mm OD X 30 cm
PB-604.25	3mm OD X 25 cm	PB-604.52	5mm OD X 20 cm	PB-604.75	6mm OD X 35 cm
PB-604.30	3mm OD X 30 cm				

60cc smart hub



Luer Lock
(Stainless Steel)



Liposuction Cannula

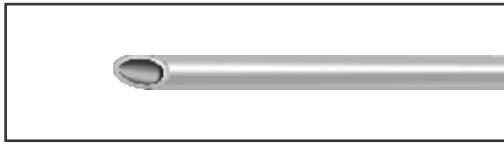

Fig. 1A

A- Power Cannula



B- Power Cannula



Available in Power Cannulas of handle A & B.

Power Cannula

PB-539.05	2mm OD X 15 cm	PB-539.35	3mm OD X 35 cm	PB-539.55	5mm OD X 25 cm
PB-539.07	2mm OD X 20 cm	PB-539.37	4mm OD X 15 cm	PB-539.57	5mm OD X 30 cm
PB-539.10	2mm OD X 25 cm	PB-539.40	4mm OD X 20 cm	PB-539.60	5mm OD X 35 cm
PB-539.12	2mm OD X 30 cm	PB-539.42	4mm OD X 25 cm	PB-539.62	6mm OD X 15 cm
PB-539.15	2mm OD X 35 cm	PB-539.45	4mm OD X 30 cm	PB-539.65	6mm OD X 20 cm
PB-539.20	3mm OD X 15 cm	PB-539.47	4mm OD X 35 cm	PB-539.67	6mm OD X 25 cm
PB-539.22	3mm OD X 20 cm	PB-539.50	5mm OD X 15 cm	PB-539.70	6mm OD X 30 cm
PB-539.25	3mm OD X 25 cm	PB-539.52	5mm OD X 20 cm	PB-539.75	6mm OD X 35 cm
PB-539.30	3mm OD X 30 cm				

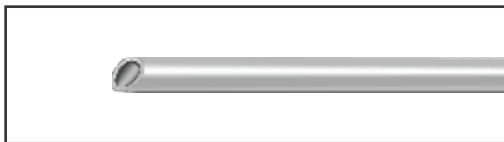

Fig. 1Z

Power Cannula

PB-540.05	2mm OD X 15 cm	PB-540.35	3mm OD X 35 cm	PB-540.55	5mm OD X 25 cm
PB-540.07	2mm OD X 20 cm	PB-540.37	4mm OD X 15 cm	PB-540.57	5mm OD X 30 cm
PB-540.10	2mm OD X 25 cm	PB-540.40	4mm OD X 20 cm	PB-540.60	5mm OD X 35 cm
PB-540.12	2mm OD X 30 cm	PB-540.42	4mm OD X 25 cm	PB-540.62	6mm OD X 15 cm
PB-540.15	2mm OD X 35 cm	PB-540.45	4mm OD X 30 cm	PB-540.65	6mm OD X 20 cm
PB-540.20	3mm OD X 15 cm	PB-540.47	4mm OD X 35 cm	PB-540.67	6mm OD X 25 cm
PB-540.22	3mm OD X 20 cm	PB-540.50	5mm OD X 15 cm	PB-540.70	6mm OD X 30 cm
PB-540.25	3mm OD X 25 cm	PB-540.52	5mm OD X 20 cm	PB-540.75	6mm OD X 35 cm
PB-540.30	3mm OD X 30 cm				

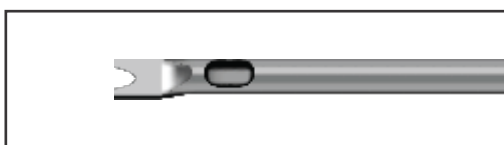

Fig. 1C

Power Cannula

PB-541.05	2mm OD X 15 cm	PB-541.35	3mm OD X 35 cm	PB-541.55	5mm OD X 25 cm
PB-541.07	2mm OD X 20 cm	PB-541.37	4mm OD X 15 cm	PB-541.57	5mm OD X 30 cm
PB-541.10	2mm OD X 25 cm	PB-541.40	4mm OD X 20 cm	PB-541.60	5mm OD X 35 cm
PB-541.12	2mm OD X 30 cm	PB-541.42	4mm OD X 25 cm	PB-541.62	6mm OD X 15 cm
PB-541.15	2mm OD X 35 cm	PB-541.45	4mm OD X 30 cm	PB-541.65	6mm OD X 20 cm
PB-541.20	3mm OD X 15 cm	PB-541.47	4mm OD X 35 cm	PB-541.67	6mm OD X 25 cm
PB-541.22	3mm OD X 20 cm	PB-541.50	5mm OD X 15 cm	PB-541.70	6mm OD X 30 cm
PB-541.25	3mm OD X 25 cm	PB-541.52	5mm OD X 20 cm	PB-541.75	6mm OD X 35 cm
PB-541.30	3mm OD X 30 cm				

Liposuction Cannula



Fig. 1La

Luer Lock
(Stainless Steel)

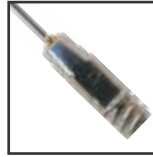

A- Power Cannula



B- Power Cannula



Available in Power Cannulas of handle A & B.

Power Cannula

PB-542.05	2mm OD X 15 cm
PB-542.07	2mm OD X 20 cm
PB-542.10	2mm OD X 25 cm
PB-542.12	2mm OD X 30 cm
PB-542.15	2mm OD X 35 cm
PB-542.20	3mm OD X 15 cm
PB-542.22	3mm OD X 20 cm
PB-542.25	3mm OD X 25 cm
PB-542.30	3mm OD X 30 cm

PB-542.35	3mm OD X 35 cm
PB-542.37	4mm OD X 15 cm
PB-542.40	4mm OD X 20 cm
PB-542.42	4mm OD X 25 cm
PB-542.45	4mm OD X 30 cm
PB-542.47	4mm OD X 35 cm
PB-542.50	5mm OD X 15 cm
PB-542.52	5mm OD X 20 cm

PB-542.55	5mm OD X 25 cm
PB-542.57	5mm OD X 30 cm
PB-542.60	5mm OD X 35 cm
PB-542.62	6mm OD X 15 cm
PB-542.65	6mm OD X 20 cm
PB-542.67	6mm OD X 25 cm
PB-542.70	6mm OD X 30 cm
PB-542.75	6mm OD X 35 cm

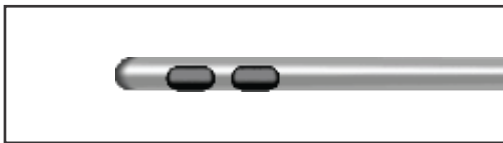

Fig. 2B

Luer lock (Stainless Steel)

	10cm	15cm	20cm	25cm
2.0Ø	PB-408.01	PB-408.11	PB-408.21	PB-408.31
2.5Ø	PB-408.02	PB-408.12	PB-408.22	PB-408.32
3.0Ø	PB-408.03	PB-408.13	PB-408.23	PB-408.33
3.5Ø	PB-408.04	PB-408.14	PB-408.24	PB-408.34
4.0Ø	PB-408.05	PB-408.15	PB-408.25	PB-408.35

Power Cannula

PB-543.05	2mm OD X 15 cm
PB-543.07	2mm OD X 20 cm
PB-543.10	2mm OD X 25 cm
PB-543.12	2mm OD X 30 cm
PB-543.15	2mm OD X 35 cm
PB-543.20	3mm OD X 15 cm
PB-543.22	3mm OD X 20 cm
PB-543.25	3mm OD X 25 cm
PB-543.30	3mm OD X 30 cm

PB-543.35	3mm OD X 35 cm
PB-543.37	4mm OD X 15 cm
PB-543.40	4mm OD X 20 cm
PB-543.42	4mm OD X 25 cm
PB-543.45	4mm OD X 30 cm
PB-543.47	4mm OD X 35 cm
PB-543.50	5mm OD X 15 cm
PB-543.52	5mm OD X 20 cm

PB-543.55	5mm OD X 25 cm
PB-543.57	5mm OD X 30 cm
PB-543.60	5mm OD X 35 cm
PB-543.62	6mm OD X 15 cm
PB-543.65	6mm OD X 20 cm
PB-543.67	6mm OD X 25 cm
PB-543.70	6mm OD X 30 cm
PB-543.75	6mm OD X 35 cm

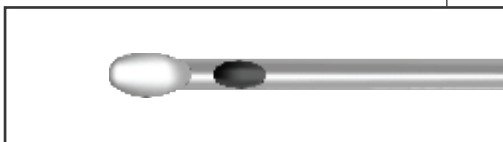

Fig. 1P

Power Cannula

PB-544.05	2mm OD X 15 cm
PB-544.07	2mm OD X 20 cm
PB-544.10	2mm OD X 25 cm
PB-544.12	2mm OD X 30 cm
PB-544.15	2mm OD X 35 cm
PB-544.20	3mm OD X 15 cm
PB-544.22	3mm OD X 20 cm
PB-544.25	3mm OD X 25 cm
PB-544.30	3mm OD X 30 cm

PB-544.35	3mm OD X 35 cm
PB-544.37	4mm OD X 15 cm
PB-544.40	4mm OD X 20 cm
PB-544.42	4mm OD X 25 cm
PB-544.45	4mm OD X 30 cm
PB-544.47	4mm OD X 35 cm
PB-544.50	5mm OD X 15 cm
PB-544.52	5mm OD X 20 cm

PB-544.55	5mm OD X 25 cm
PB-544.57	5mm OD X 30 cm
PB-544.60	5mm OD X 35 cm
PB-544.62	6mm OD X 15 cm
PB-544.65	6mm OD X 20 cm
PB-544.67	6mm OD X 25 cm
PB-544.70	6mm OD X 30 cm
PB-544.75	6mm OD X 35 cm

Liposuction Cannula

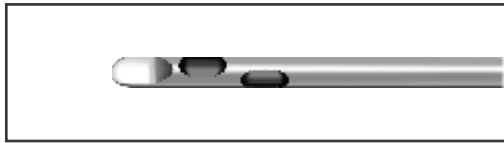

Fig. 1FC

A- Power Cannula



B- Power Cannula



Available in Power Cannulas of handle A & B.

Power Cannula

PB-545.05	2mm OD X 15 cm	PB-545.35	3mm OD X 35 cm	PB-545.55	5mm OD X 25 cm
PB-545.07	2mm OD X 20 cm	PB-545.37	4mm OD X 15 cm	PB-545.57	5mm OD X 30 cm
PB-545.10	2mm OD X 25 cm	PB-545.40	4mm OD X 20 cm	PB-545.60	5mm OD X 35 cm
PB-545.12	2mm OD X 30 cm	PB-545.42	4mm OD X 25 cm	PB-545.62	6mm OD X 15 cm
PB-545.15	2mm OD X 35 cm	PB-545.45	4mm OD X 30 cm	PB-545.65	6mm OD X 20 cm
PB-545.20	3mm OD X 15 cm	PB-545.47	4mm OD X 35 cm	PB-545.67	6mm OD X 25 cm
PB-545.22	3mm OD X 20 cm	PB-545.50	5mm OD X 15 cm	PB-545.70	6mm OD X 30 cm
PB-545.25	3mm OD X 25 cm	PB-545.52	5mm OD X 20 cm	PB-545.75	6mm OD X 35 cm
PB-545.30	3mm OD X 30 cm				



Fig. 3F

Power Cannula

PB-546.05	2mm OD X 15 cm	PB-546.35	3mm OD X 35 cm	PB-546.55	5mm OD X 25 cm
PB-546.07	2mm OD X 20 cm	PB-546.37	4mm OD X 15 cm	PB-546.57	5mm OD X 30 cm
PB-546.10	2mm OD X 25 cm	PB-546.40	4mm OD X 20 cm	PB-546.60	5mm OD X 35 cm
PB-546.12	2mm OD X 30 cm	PB-546.42	4mm OD X 25 cm	PB-546.62	6mm OD X 15 cm
PB-546.15	2mm OD X 35 cm	PB-546.45	4mm OD X 30 cm	PB-546.65	6mm OD X 20 cm
PB-546.20	3mm OD X 15 cm	PB-546.47	4mm OD X 35 cm	PB-546.67	6mm OD X 25 cm
PB-546.22	3mm OD X 20 cm	PB-546.50	5mm OD X 15 cm	PB-546.70	6mm OD X 30 cm
PB-546.25	3mm OD X 25 cm	PB-546.52	5mm OD X 20 cm	PB-546.75	6mm OD X 35 cm
PB-546.30	3mm OD X 30 cm				

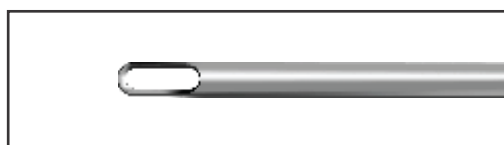

Fig. 2Ech

Power Cannula

PB-547.05	2mm OD X 15 cm	PB-547.35	3mm OD X 35 cm	PB-547.55	5mm OD X 25 cm
PB-547.07	2mm OD X 20 cm	PB-547.37	4mm OD X 15 cm	PB-547.57	5mm OD X 30 cm
PB-547.10	2mm OD X 25 cm	PB-547.40	4mm OD X 20 cm	PB-547.60	5mm OD X 35 cm
PB-547.12	2mm OD X 30 cm	PB-547.42	4mm OD X 25 cm	PB-547.62	6mm OD X 15 cm
PB-547.15	2mm OD X 35 cm	PB-547.45	4mm OD X 30 cm	PB-547.65	6mm OD X 20 cm
PB-547.20	3mm OD X 15 cm	PB-547.47	4mm OD X 35 cm	PB-547.67	6mm OD X 25 cm
PB-547.22	3mm OD X 20 cm	PB-547.50	5mm OD X 15 cm	PB-547.70	6mm OD X 30 cm
PB-547.25	3mm OD X 25 cm	PB-547.52	5mm OD X 20 cm	PB-547.75	6mm OD X 35 cm
PB-547.30	3mm OD X 30 cm				

Liposuction Cannula

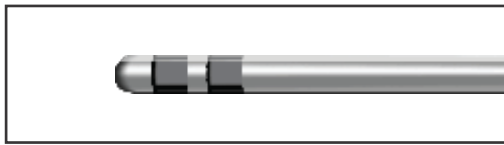

Fig. 2Ba

Luer Lock
(Stainless Steel)



A- Power Cannula



B- Power Cannula



Available in Power Cannulas of handle A & B.

Luer lock (Stainless Steel)

	7cm	10cm	15cm	20cm	25cm
2.0Ø	PB-560.41	PB-560.51	PB-560.61	PB-560.71	PB-560.81
2.5Ø	PB-560.42	PB-560.52	PB-560.62	PB-560.72	PB-560.82
3.0Ø	PB-560.43	PB-560.53	PB-560.63	PB-560.73	PB-560.83
3.5Ø	PB-560.44	PB-560.54	PB-560.64	PB-560.74	PB-560.84
4.0Ø	PB-560.45	PB-560.55	PB-560.65	PB-560.75	PB-560.85

Power Cannula

PB-548.05	2mm OD X 15 cm	PB-547.35	3mm OD X 35 cm	PB-548.55	5mm OD X 25 cm
PB-548.07	2mm OD X 20 cm	PB-547.37	4mm OD X 15 cm	PB-548.57	5mm OD X 30 cm
PB-548.10	2mm OD X 25 cm	PB-548.40	4mm OD X 20 cm	PB-548.60	5mm OD X 35 cm
PB-548.12	2mm OD X 30 cm	PB-548.42	4mm OD X 25 cm	PB-548.62	6mm OD X 15 cm
PB-548.15	2mm OD X 35 cm	PB-548.45	4mm OD X 30 cm	PB-548.65	6mm OD X 20 cm
PB-548.20	3mm OD X 15 cm	PB-548.47	4mm OD X 35 cm	PB-548.67	6mm OD X 25 cm
PB-548.22	3mm OD X 20 cm	PB-548.50	5mm OD X 15 cm	PB-548.70	6mm OD X 30 cm
PB-548.25	3mm OD X 25 cm	PB-548.52	5mm OD X 20 cm	PB-548.75	6mm OD X 35 cm
PB-548.30	3mm OD X 30 cm				



Fig. 3G

Power Cannula

PB-549.05	2mm OD X 15 cm	PB-549.35	3mm OD X 35 cm	PB-549.55	5mm OD X 25 cm
PB-549.07	2mm OD X 20 cm	PB-549.37	4mm OD X 15 cm	PB-549.57	5mm OD X 30 cm
PB-549.10	2mm OD X 25 cm	PB-549.40	4mm OD X 20 cm	PB-549.60	5mm OD X 35 cm
PB-549.12	2mm OD X 30 cm	PB-549.42	4mm OD X 25 cm	PB-549.62	6mm OD X 15 cm
PB-549.15	2mm OD X 35 cm	PB-549.45	4mm OD X 30 cm	PB-549.65	6mm OD X 20 cm
PB-549.20	3mm OD X 15 cm	PB-549.47	4mm OD X 35 cm	PB-549.67	6mm OD X 25 cm
PB-549.22	3mm OD X 20 cm	PB-549.50	5mm OD X 15 cm	PB-549.70	6mm OD X 30 cm
PB-549.25	3mm OD X 25 cm	PB-549.52	5mm OD X 20 cm	PB-549.75	6mm OD X 35 cm
PB-549.30	3mm OD X 30 cm				



Fig. 3H

Power Cannula

PB-550.05	2mm OD X 15 cm	PB-550.35	3mm OD X 35 cm	PB-550.55	5mm OD X 25 cm
PB-550.07	2mm OD X 20 cm	PB-550.37	4mm OD X 15 cm	PB-550.57	5mm OD X 30 cm
PB-550.10	2mm OD X 25 cm	PB-550.40	4mm OD X 20 cm	PB-550.60	5mm OD X 35 cm
PB-550.12	2mm OD X 30 cm	PB-550.42	4mm OD X 25 cm	PB-550.62	6mm OD X 15 cm
PB-550.15	2mm OD X 35 cm	PB-550.45	4mm OD X 30 cm	PB-550.65	6mm OD X 20 cm
PB-400.36	3mm OD X 15 cm	PB-550.47	4mm OD X 35 cm	PB-550.67	6mm OD X 25 cm
PB-550.22	3mm OD X 20 cm	PB-550.50	5mm OD X 15 cm	PB-550.70	6mm OD X 30 cm
PB-550.25	3mm OD X 25 cm	PB-550.52	5mm OD X 20 cm	PB-550.75	6mm OD X 35 cm
PB-550.30	3mm OD X 30 cm				

Liposuction Cannula

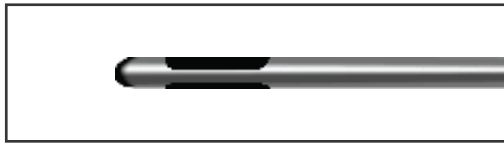

Fig. 3Me

Luer lock (Stainless Steel)

	7cm	10cm	15cm	20cm	25cm
2.0Ø	PB-603.01	PB-603.11	PB-603.21	PB-400.45	PB-603.41
2.5Ø	PB-603.02	PB-603.12	PB-400.30	PB-603.32	PB-603.42
3.0Ø	PB-603.03	PB-603.13	PB-603.36	PB-603.33	PB-603.43
3.5Ø	PB-603.04	PB-603.14	PB-603.24	PB-603.34	PB-603.44
4.0Ø	PB-603.05	PB-603.15	PB-603.25	PB-603.35	PB-603.45

Power Cannula

PB-551.05	2mm OD X 15 cm	PB-551.35	3mm OD X 35 cm	PB-551.55	5mm OD X 25 cm
PB-551.07	2mm OD X 20 cm	PB-551.37	4mm OD X 15 cm	PB-551.57	5mm OD X 30 cm
PB-551.10	2mm OD X 25 cm	PB-551.40	4mm OD X 20 cm	PB-551.60	5mm OD X 35 cm
PB-551.12	2mm OD X 30 cm	PB-551.42	4mm OD X 25 cm	PB-551.62	6mm OD X 15 cm
PB-551.15	2mm OD X 35 cm	PB-551.45	4mm OD X 30 cm	PB-551.65	6mm OD X 20 cm
PB-551.20	3mm OD X 15 cm	PB-551.47	4mm OD X 35 cm	PB-551.67	6mm OD X 25 cm
PB-551.22	3mm OD X 20 cm	PB-551.50	5mm OD X 15 cm	PB-551.70	6mm OD X 30 cm
PB-551.25	3mm OD X 25 cm	PB-551.52	5mm OD X 20 cm	PB-551.75	6mm OD X 35 cm
PB-551.30	3mm OD X 30 cm				



Fig. 3Hr

Power Cannula

PB-552.05	2mm OD X 15 cm	PB-552.35	3mm OD X 35 cm	PB-552.55	5mm OD X 25 cm
PB-552.07	2mm OD X 20 cm	PB-552.37	4mm OD X 15 cm	PB-552.57	5mm OD X 30 cm
PB-552.10	2mm OD X 25 cm	PB-552.40	4mm OD X 20 cm	PB-552.60	5mm OD X 35 cm
PB-552.12	2mm OD X 30 cm	PB-552.42	4mm OD X 25 cm	PB-552.62	6mm OD X 15 cm
PB-552.15	2mm OD X 35 cm	PB-552.45	4mm OD X 30 cm	PB-552.65	6mm OD X 20 cm
PB-552.20	3mm OD X 15 cm	PB-552.47	4mm OD X 35 cm	PB-552.67	6mm OD X 25 cm
PB-552.22	3mm OD X 20 cm	PB-552.50	5mm OD X 15 cm	PB-552.70	6mm OD X 30 cm
PB-552.25	3mm OD X 25 cm	PB-552.52	5mm OD X 20 cm	PB-552.75	6mm OD X 35 cm
PB-552.30	3mm OD X 30 cm				



Fig. Riz

Power Cannula

PB-553.05	2mm OD X 15 cm	PB-553.35	3mm OD X 35 cm	PB-553.55	5mm OD X 25 cm
PB-553.07	2mm OD X 20 cm	PB-553.37	4mm OD X 15 cm	PB-553.57	5mm OD X 30 cm
PB-553.10	2mm OD X 25 cm	PB-553.40	4mm OD X 20 cm	PB-553.60	5mm OD X 35 cm
PB-553.12	2mm OD X 30 cm	PB-553.42	4mm OD X 25 cm	PB-553.62	6mm OD X 15 cm
PB-553.15	2mm OD X 35 cm	PB-553.45	4mm OD X 30 cm	PB-553.65	6mm OD X 20 cm
PB-553.20	3mm OD X 15 cm	PB-553.47	4mm OD X 35 cm	PB-553.67	6mm OD X 25 cm
PB-553.22	3mm OD X 20 cm	PB-553.50	5mm OD X 15 cm	PB-553.70	6mm OD X 30 cm
PB-553.25	3mm OD X 25 cm	PB-553.52	5mm OD X 20 cm	PB-553.75	6mm OD X 35 cm
PB-553.30	3mm OD X 30 cm				

A- Power Cannula



B- Power Cannula



Available in Power Cannulas of handle A & B.

Liposuction Cannula

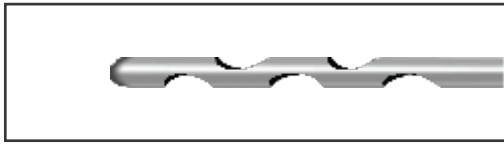

Fig. 5Ai

A- Power Cannula



B- Power Cannula



Available in Power Cannulas of handle A & B.

Power Cannula

PB-554.05	2mm OD X 15 cm	PB-554.35	3mm OD X 35 cm	PB-554.55	5mm OD X 25 cm
PB-554.07	2mm OD X 20 cm	PB-554.37	4mm OD X 15 cm	PB-554.57	5mm OD X 30 cm
PB-554.10	2mm OD X 25 cm	PB-554.40	4mm OD X 20 cm	PB-557.60	5mm OD X 35 cm
PB-554.12	2mm OD X 30 cm	PB-554.42	4mm OD X 25 cm	PB-557.62	6mm OD X 15 cm
PB-554.15	2mm OD X 35 cm	PB-554.45	4mm OD X 30 cm	PB-557.65	6mm OD X 20 cm
PB-554.20	3mm OD X 15 cm	PB-554.47	4mm OD X 35 cm	PB-557.67	6mm OD X 25 cm
PB-554.22	3mm OD X 20 cm	PB-554.50	5mm OD X 15 cm	PB-557.70	6mm OD X 30 cm
PB-554.25	3mm OD X 25 cm	PB-554.52	5mm OD X 20 cm	PB-557.75	6mm OD X 35 cm
PB-554.30	3mm OD X 30 cm				

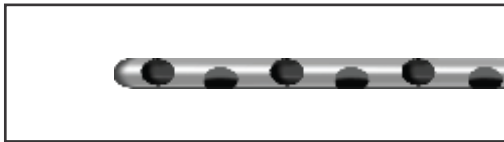

Fig. Mr

Power Cannula

PB-555.05	2mm OD X 15 cm	PB-555.35	3mm OD X 35 cm	PB-555.55	5mm OD X 25 cm
PB-555.07	2mm OD X 20 cm	PB-555.37	4mm OD X 15 cm	PB-555.57	5mm OD X 30 cm
PB-555.10	2mm OD X 25 cm	PB-555.40	4mm OD X 20 cm	PB-555.60	5mm OD X 35 cm
PB-555.12	2mm OD X 30 cm	PB-555.42	4mm OD X 25 cm	PB-555.62	6mm OD X 15 cm
PB-555.15	2mm OD X 35 cm	PB-555.45	4mm OD X 30 cm	PB-555.65	6mm OD X 20 cm
PB-555.20	3mm OD X 15 cm	PB-555.47	4mm OD X 35 cm	PB-555.67	6mm OD X 25 cm
PB-555.22	3mm OD X 20 cm	PB-555.50	5mm OD X 15 cm	PB-555.70	6mm OD X 30 cm
PB-555.25	3mm OD X 25 cm	PB-555.52	5mm OD X 20 cm	PB-555.75	6mm OD X 35 cm
PB-555.30	3mm OD X 30 cm				



Fig. P3G

Power Cannula

PB-556.05	2mm OD X 15 cm	PB-556.35	3mm OD X 35 cm	PB-556.55	5mm OD X 25 cm
PB-556.07	2mm OD X 20 cm	PB-556.37	4mm OD X 15 cm	PB-556.57	5mm OD X 30 cm
PB-556.10	2mm OD X 25 cm	PB-556.40	4mm OD X 20 cm	PB-556.60	5mm OD X 35 cm
PB-556.12	2mm OD X 30 cm	PB-556.42	4mm OD X 25 cm	PB-556.62	6mm OD X 15 cm
PB-556.15	2mm OD X 35 cm	PB-556.45	4mm OD X 30 cm	PB-556.65	6mm OD X 20 cm
PB-556.20	3mm OD X 15 cm	PB-556.47	4mm OD X 35 cm	PB-556.67	6mm OD X 25 cm
PB-556.22	3mm OD X 20 cm	PB-556.50	5mm OD X 15 cm	PB-556.70	6mm OD X 30 cm
PB-556.25	3mm OD X 25 cm	PB-556.52	5mm OD X 20 cm	PB-556.75	6mm OD X 35 cm
PB-556.30	3mm OD X 30 cm				

Liposuction Cannula

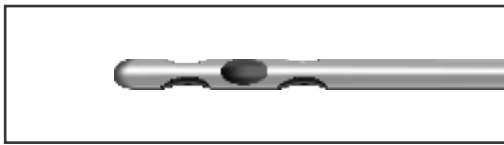

Fig. Py

Power Cannula

PB-557.05	2mm OD X 15 cm	PB-557.35	3mm OD X 35 cm	PB-557.55	5mm OD X 25 cm
PB-557.07	2mm OD X 20 cm	PB-557.37	4mm OD X 15 cm	PB-557.57	5mm OD X 30 cm
PB-557.10	2mm OD X 25 cm	PB-557.40	4mm OD X 20 cm	PB-557.60	5mm OD X 35 cm
PB-557.12	2mm OD X 30 cm	PB-557.42	4mm OD X 25 cm	PB-557.62	6mm OD X 15 cm
PB-557.15	2mm OD X 35 cm	PB-557.45	4mm OD X 30 cm	PB-557.65	6mm OD X 20 cm
PB-557.20	3mm OD X 15 cm	PB-557.47	4mm OD X 35 cm	PB-557.67	6mm OD X 25 cm
PB-557.22	3mm OD X 20 cm	PB-557.50	5mm OD X 15 cm	PB-557.70	6mm OD X 30 cm
PB-557.25	3mm OD X 25 cm	PB-557.52	5mm OD X 20 cm	PB-557.75	6mm OD X 35 cm
PB-557.30	3mm OD X 30 cm				

A- Power Cannula



B- Power Cannula



Available in Power Cannulas of handle A & B.

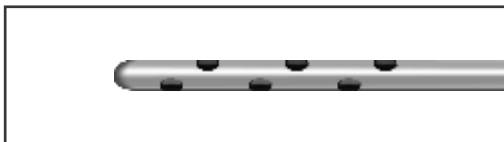

Fig. Le

Power Cannula

PB-558.05	2mm OD X 15 cm	PB-558.35	3mm OD X 35 cm	PB-558.55	5mm OD X 25 cm
PB-558.07	2mm OD X 20 cm	PB-558.37	4mm OD X 15 cm	PB-558.57	5mm OD X 30 cm
PB-558.10	2mm OD X 25 cm	PB-558.40	4mm OD X 20 cm	PB-558.60	5mm OD X 35 cm
PB-558.12	2mm OD X 30 cm	PB-558.42	4mm OD X 25 cm	PB-558.62	6mm OD X 15 cm
PB-558.15	2mm OD X 35 cm	PB-558.45	4mm OD X 30 cm	PB-558.65	6mm OD X 20 cm
PB-558.20	3mm OD X 15 cm	PB-558.47	4mm OD X 35 cm	PB-558.67	6mm OD X 25 cm
PB-558.22	3mm OD X 20 cm	PB-558.50	5mm OD X 15 cm	PB-558.70	6mm OD X 30 cm
PB-558.25	3mm OD X 25 cm	PB-558.52	5mm OD X 20 cm	PB-558.75	6mm OD X 35 cm
PB-558.30	3mm OD X 30 cm				



Fig. R. Pontes

Power Cannula

PB-559.05	2mm OD X 15 cm	PB-559.35	3mm OD X 35 cm	PB-559.55	5mm OD X 25 cm
PB-559.07	2mm OD X 20 cm	PB-559.37	4mm OD X 15 cm	PB-559.57	5mm OD X 30 cm
PB-559.10	2mm OD X 25 cm	PB-559.40	4mm OD X 20 cm	PB-559.60	5mm OD X 35 cm
PB-559.12	2mm OD X 30 cm	PB-559.42	4mm OD X 25 cm	PB-559.62	6mm OD X 15 cm
PB-559.15	2mm OD X 35 cm	PB-559.45	4mm OD X 30 cm	PB-559.65	6mm OD X 20 cm
PB-559.20	3mm OD X 15 cm	PB-559.47	4mm OD X 35 cm	PB-559.67	6mm OD X 25 cm
PB-559.22	3mm OD X 20 cm	PB-559.50	5mm OD X 15 cm	PB-559.70	6mm OD X 30 cm
PB-559.25	3mm OD X 25 cm	PB-559.52	5mm OD X 20 cm	PB-559.75	6mm OD X 35 cm
PB-559.30	3mm OD X 30 cm				

Liposuction Cannula

Micro Injectors

29ADE3



Sharp Extractor/Injector

This tip works well for needle extraction of soft tissue and as a soft tissue reinjection needle.

Super Luer lock

PB-537.45	1.00mm X 5 cm
PB-537.47	1.20mm X 7 cm
PB-537.50	2.00mm X 15 cm
PB-537.52	2.50mm X 15 cm
PB-537.55	3.00mm X 15 cm

Luer lock

PB-537.65	1.00mm X 5 cm
PB-537.67	1.20mm X 7 cm
PB-537.70	2.00mm X 15 cm
PB-537.72	2.50mm X 15 cm
PB-537.75	3.00mm X 15 cm

Luer lock (Stainless Steel)

	3cm	5cm	7cm	10cm	12cm
1.1Ø	PB-404.01	PB-404.11	PB-404.21	PB-404.31	PB-404.41
1.4Ø	PB-404.02	PB-404.12	PB-404.22	PB-404.32	PB-404.42
1.8Ø	PB-404.03	PB-404.13	PB-404.23	PB-404.33	PB-404.43
2.0Ø	PB-404.04	PB-404.14	PB-404.24	PB-404.34	PB-404.44



Blunt Extractor/Injector

This tip works well for needle extraction of soft tissue and as a soft tissue reinjection needle.

Super Luer lock

PB-537.05	2.00mm X 15 cm
PB-537.10	2.50mm X 15 cm
PB-537.15	3.00mm X 15 cm

Luer lock

PB-537.20	2.00mm X 15 cm
PB-537.22	2.50mm X 15 cm
PB-537.25	3.00mm X 15 cm

Luer lock (Stainless Steel)

	3cm	5cm	7cm	10cm	12cm
1.1Ø	PB-404.51	PB-404.61	PB-404.71	PB-404.81	PB-404.91
1.4Ø	PB-404.52	PB-404.62	PB-404.72	PB-404.82	PB-404.92
1.8Ø	PB-404.53	PB-404.63	PB-404.73	PB-404.83	PB-404.93
2.0Ø	PB-404.54	PB-404.64	PB-404.74	PB-404.84	PB-404.94

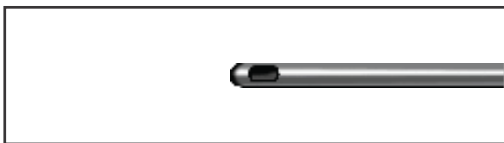

Injector

Rounded blunt tip design passes through soft tissue easily without the trauma or potential problems of sharp instruments.

Super Luer lock

PB-532.24	100mm X 4 cm
PB-532.26	1.00mm X 5 cm
PB-532.28	1.20mm X 7 cm
PB-532.30	Curved 17GA x 12 cm
PB-532.32	Curved 17GA x 15 cm
PB-532.34	Curved 17GA x 20 cm
PB-532.36	Curved 16GA x 12 cm
PB-532.38	Curved 16GA x 15 cm
PB-532.40	Curved 16GA x 20 cm

Luer lock

PB-532.44	(20GA) 100mm X 4 cm
PB-532.46	(19GA) 1.00mm X 5 cm
PB-532.48	(18GA) 1.20mm X 7 cm
PB-532.50	Curved 17GA x 12 cm
PB-532.52	Curved 17GA x 15 cm
PB-532.54	Curved 17GA x 20 cm
PB-532.56	Curved 16GA x 12 cm
PB-532.58	Curved 16GA x 15 cm
PB-532.60	Curved 16GA x 20 cm

Super Luer Lock

Luer Lock

Luer Lock
(Stainless Steel)

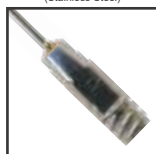

Liposuction Cannula

Luer lock (Stainless Steel)

	3cm	5cm	7cm	10cm	12cm
1.1Ø	PB-405.01	PB-405.11	PB-405.21	PB-405.31	PB-405.41
1.4Ø	PB-405.02	PB-405.12	PB-405.22	PB-405.32	PB-405.42
1.8Ø	PB-405.03	PB-405.13	PB-405.23	PB-405.33	PB-405.43
2.0Ø	PB-405.04	PB-405.14	PB-405.24	PB-405.34	PB-405.44



Fig. 2B

Luer lock (Stainless Steel)

	3cm	5cm	7cm	10cm	12cm
1.1Ø	PB-402.01	PB-402.11	PB-402.21	PB-402.31	PB-402.41
1.4Ø	PB-402.02	PB-402.12	PB-402.22	PB-402.32	PB-402.42
1.8Ø	PB-402.03	PB-402.13	PB-402.23	PB-402.33	PB-402.43
2.0Ø	PB-402.04	PB-402.14	PB-402.24	PB-400.22	PB-402.44

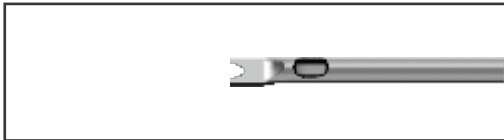

Fig. 1C

Luer lock (Stainless Steel)

	3cm	5cm	7cm	10cm	12cm
1.1Ø	PB-402.51	PB-402.61	PB-402.71	PB-402.81	PB-402.91
1.4Ø	PB-402.52	PB-402.62	PB-402.72	PB-402.82	PB-402.92
1.8Ø	PB-402.53	PB-402.63	PB-402.73	PB-402.83	PB-402.93
2.0Ø	PB-402.54	PB-402.64	PB-402.74	PB-402.84	PB-400.65



Fig. 1P

Luer lock (Stainless Steel)

	3cm	5cm	7cm	10cm	12cm
1.1Ø	PB-403.01	PB-403.11	PB-403.21	PB-403.31	PB-403.41
1.4Ø	PB-403.02	PB-403.12	PB-403.22	PB-403.32	PB-403.42
1.8Ø	PB-403.03	PB-403.13	PB-403.23	PB-403.33	PB-403.43
2.0Ø	PB-403.04	PB-403.14	PB-403.24	PB-403.34	PB-403.44



Fig. 2E

Luer lock (Stainless Steel)

	3cm	5cm	7cm	10cm	12cm
1.1Ø	PB-403.51	PB-403.61	PB-403.71	PB-403.81	PB-403.91
1.4Ø	PB-403.52	PB-403.62	PB-403.72	PB-403.82	PB-403.92
1.8Ø	PB-403.53	PB-403.63	PB-403.73	PB-403.83	PB-403.93
2.0Ø	PB-403.54	PB-403.64	PB-403.74	PB-403.84	PB-403.94

Luer Lock
(Stainless Steel)



Liposuction Cannula

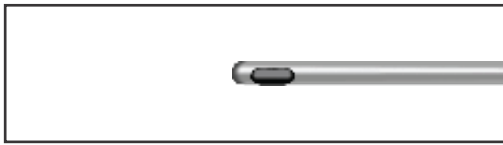

Coleman Liposuction Cannula Fig. MIC I

Luer lock (Stainless Steel)

	3cm	5cm	7cm	10cm	12cm	15cm	20cm	3.5cm
1.1Ø	PB-401.01	PB-400.50	PB-401.13	PB-401.14	PB-401.15	PB-401.26	PB-401.32	PB-400.35
1.4Ø	PB-401.02	PB-401.10	PB-401.44	PB-401.04	PB-401.16	PB-401.27	PB-401.33	
1.8Ø	PB-401.03	PB-401.09	PB-401.54	PB-401.18	PB-401.17	PB-401.28	PB-401.34	
2.0Ø	PB-401.07	PB-401.11	PB-401.64	PB-401.21	PB-401.24	PB-401.29	PB-401.38	
2.5Ø	PB-401.08	PB-401.12	PB-401.74	PB-401.35	PB-401.25	PB-401.31	PB-401.39	



Coleman Liposuction Cannula Fig. MIC II

Luer lock (Stainless Steel)

	3cm	5cm	7cm	10cm	12cm	15cm	20cm
1.1Ø	PB-409.01	PB-409.11	PB-400.70	PB-409.31	PB-409.41	PB-409.51	PB-409.61
1.4Ø	PB-409.02	PB-409.12	PB-401.45	PB-401.05	PB-409.42	PB-409.52	PB-409.62
1.8Ø	PB-409.03	PB-409.13	PB-401.55	PB-401.19	PB-409.43	PB-401.30	PB-409.63
2.0Ø	PB-409.04	PB-409.14	PB-401.65	PB-401.22	PB-409.44	PB-400.60	PB-409.64
2.5Ø	PB-409.05	PB-409.15	PB-409.22	PB-401.36	PB-409.45	PB-401.70	PB-409.65

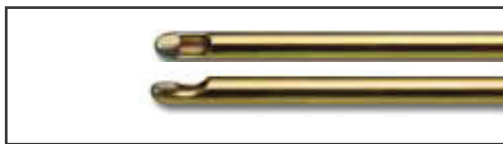

Coleman Liposuction Cannula Spoon Tip Fig. MIC III

This tip works well for needle extraction of soft tissue and as a soft tissue re-injection needle.

Luer lock (Stainless Steel)

	3cm	5cm	7cm	10cm	12cm	15cm	20cm
1.1Ø	PB-410.01	PB-410.11	PB-410.21	PB-410.31	PB-410.41	PB-410.51	PB-410.61
1.4Ø	PB-410.02	PB-410.12	PB-401.46	PB-401.06	PB-410.42	PB-410.52	PB-410.62
1.8Ø	PB-410.03	PB-410.13	PB-401.56	PB-401.20	PB-410.43	PB-410.53	PB-401.50
2.0Ø	PB-410.04	PB-410.14	PB-401.66	PB-401.23	PB-410.44	PB-401.40	PB-410.64
2.5Ø	PB-410.05	PB-410.15	PB-401.76	PB-410.37	PB-410.45	PB-410.55	PB-410.65

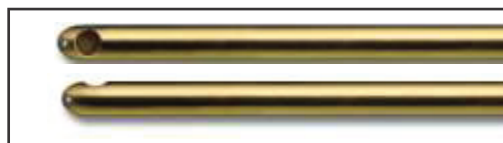

Little Injector

Open and more pointed blunt tip is very effective in dense and fibrous tissue.

Super Luer lock

PB-533.04	100mm X 4 cm
PB-533.05	1.00mm X 5 cm
PB-533.07	1.20mm X 7 cm

Luer lock

PB-533.14	100mm X 4 cm
PB-533.15	1.00mm X 5 cm
PB-533.17	1.20mm X 7 cm

Super Luer Lock



Luer Lock (Stainless Steel)



Liposuction Cannula

Luer lock (Stainless Steel)

	3cm	5cm	7cm	10cm	12cm
1.1Ø	PB-533.21	PB-533.26	PB-533.31	PB-533.36	PB-533.41
1.4Ø	PB-533.22	PB-533.27	PB-533.32	PB-533.37	PB-533.42
1.8Ø	PB-533.23	PB-533.28	PB-533.33	PB-533.38	PB-533.43
2.0Ø	PB-533.24	PB-533.29	PB-533.34	PB-533.39	PB-533.44

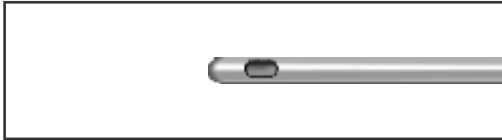
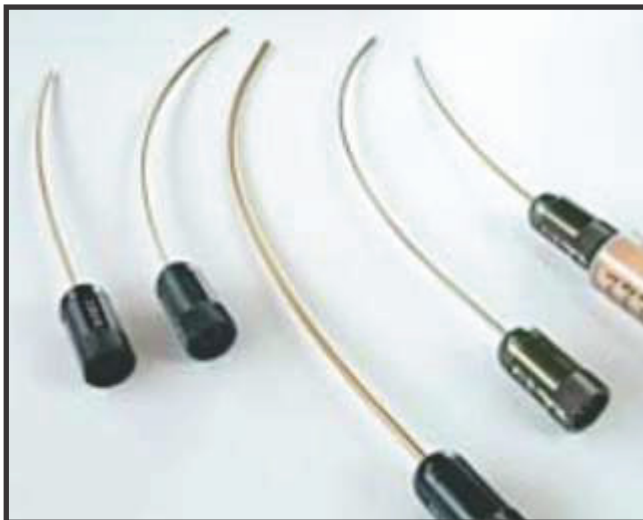

Fig. 1B

Luer lock (Stainless Steel)

	3cm	5cm	7cm	10cm	12cm	15cm	20cm
1.1Ø	PB-405.01	PB-400.05	PB-400.07	PB-405.31	PB-400.12	PB-401.51	PB-401.61
1.4Ø	PB-405.02	PB-405.11	PB-405.21	PB-400.10	PB-401.41	PB-401.52	PB-401.62
1.8Ø	PB-405.03	PB-405.12	PB-405.22	PB-405.32	PB-401.42	PB-400.15	PB-401.63
2.0Ø	PB-405.04	PB-405.13	PB-405.23	PB-405.33	PB-401.43	PB-400.20	PB-401.64
2.5Ø	PB-405.05	PB-405.14	PB-405.24	PB-405.34	PB-411.44	PB-401.53	PB-401.65

Curved Injectors



Curved Injectors

New Curved Injectors are designed especially for fat transfer procedures to the body. Their unique shape mimics the anatomical curvature of the female torso and, thus, easily produces the natural-looking results that patients desire. Curved Injection Cannulas ameliorate the fat transfer process by providing a direct and precise route to the injection site and by lessening the time required to correctly sculpt curves.

Luer Lock (Stainless Steel)



Liposuction Cannula

Single -Use Instruments

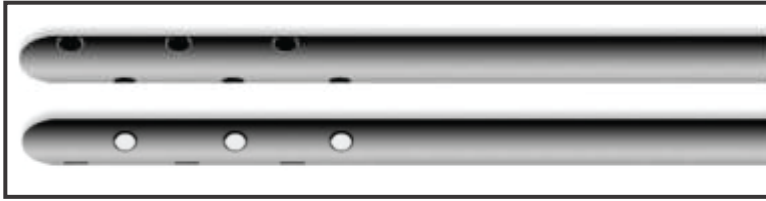
**Tumescant Infiltrator**

This cannula is used specifically for the infusion of tumescant solution and for hydraulic dissection. the configuration of the ports allows even distribution of the fluid.
 SB-571.01 Ø2.00mm x 12cm
 SB-571.10 Ø2.00mm x 20cm

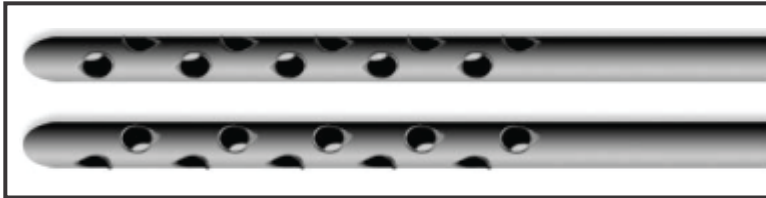
**Tonnard Harvester**

A multiport harvester with 1mm elevated sharp microports. The 20 port configuration allows for harvesting both on the forward and backward strokes.
 SB-571.11 Ø3.00mm x 20cm
 SB-571.20 Ø2.50mm x 20cm

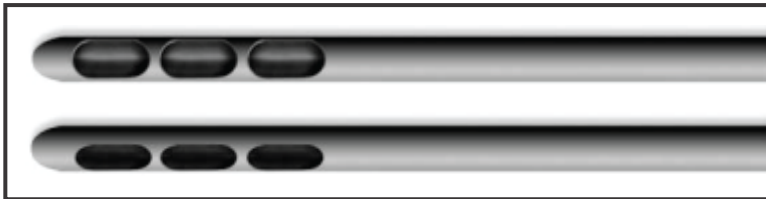
**Tonnard Harvester**

Excellent for harvesting small aliquots of tissues.
 SB-571.21 Ø2.50mm x 15cm
 SB-571.30 Ø2.00mm x 15cm

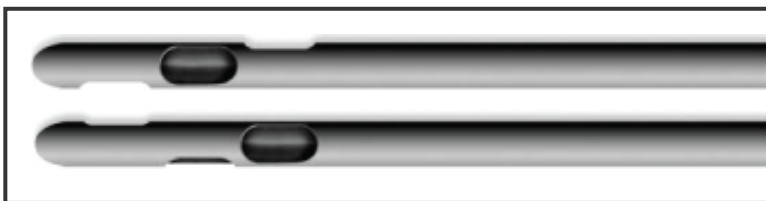
**Carraway Harvester**

Spiral three port design effective for multi-plane tissue harvesting.
 SB-571.31 Ø 2.50mm x 15cm
 SB-571.33 Ø 2.00mm x 10cm
 SB-571.35 Ø 2.00mm x 15cm
 SB-571.37 Ø 1.65mm x 8cm
 SB-571.40 Ø 1.65mm x 10cm

**Injector**

Round blunt tip design passes through soft tissue easily without the trauma or potential problems of sharp injectors.
 SB-571.51 Ø 1.50mm x 9cm
 SB-571.53 Ø 1.30mm x 7cm
 SB-571.55 Ø 1.00mm x 5cm
 SB-571.57 Ø 0.90mm x 4cm
 SB-571.60 Ø 0.60mm x 4cm
 SB-571.65 Ø 0.50mm x 3cm

**Spoon Tip Injector**

Blunt injector designed with a more open port for rapid injection of larger volumes - a torso and buttock workhorse.
 SB-571.71 Ø 3.00mm x 20cm
 SB-571.75 Ø 2.00mm x 15cm

**Miller Speed Harvester**

SB-571.85 Ø 2.00mm x 15cm

**Super Luer Lock**

The Super Luer Lock is on our Single-use instruments.

Anaerobic Transfer & Power Adaptor



Anaerobic Transfer

Anaerobic transfer are used to prepare and transfer extracted tissue for re-injection. The decant stand design also allows for a natural gravity decant.

Decant Stands

- PB-600.00 • 60cc to 60cc
- PB-600.10 • 60cc to Luer
- PB-600.20 • Luer to Luer

Anaerobic Transfers

- PB-600.50 • Luer to Luer
- PB-402.00 • 20cc to 20cc



Power Adaptor

The power Adaptor modifies the cannula and the syringe for use with an aspirating machine.

- PB-601.60 60cc Monoject
- PB-601.30 30cc Monoject
- PB-601.21 20cc BD
- PB-601.20 20cc Monoject
- PB-601.11 10cc BD
- PB-601.10 10/12cc Monoject

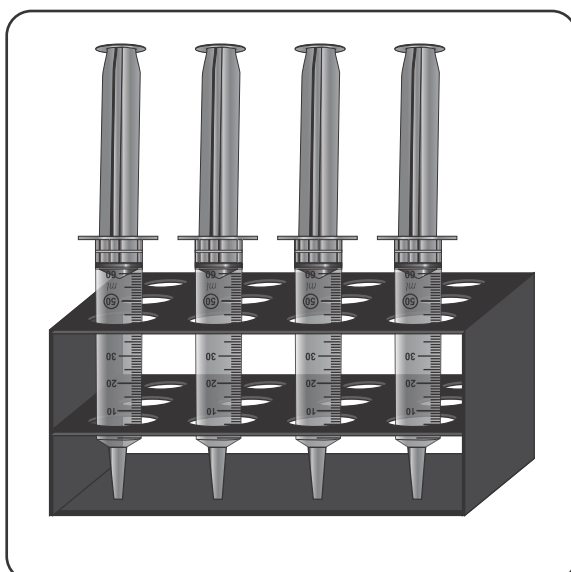

Syringe Decanting and Injection

- PB-602.60 60 cc
- PB-602.50 50 cc
- PB-602.30 30 cc
- PB-602.20 20 cc
- PB-602.10 10 cc

Liposuction Cannula

Universal Power Injector



Universal Power Injector

PB-650.00

The Power Injector allows the surgeon to re-inject soft tissue through large or small diameter injectors with very little effort and maximum control. The Universal Power Injector will hold a 10cc or a 20cc BD syringe or a BD syringe or a 60cc Monoject syringe.



SnapLoks

These syringe snap locks fit into the lunger flanges of the syringe. When the plunger is pulled out the lock snaps open on the barrel lip thus holding the syringe under vacuum.

PB-403.60	60cc
PB-403.50	50cc
PB-403.35	30cc
PB-403.20	20cc
PB-403.10	10cc



Syringe Locks

Available in six popular syringe sizes.

PB-403.160	60cc Monoject
PB-403.135	30cc Monoject
PB-403.120	20cc BD
PB-403.121	20cc Monoject
PB-403.110	10cc BD
PB-403.112	10/12cc Monoject



Mammoplasty

Areola Marker and
Breast Elevator

marcadores para aréola
y elevador mamario

maqueurs pour l'aréole
et élévateur mammaire

marcatori per areola
e elevators mamario

Breast elevator



PY-90.00
28 cm / 11"



PAF-06.06
Ø = 6 cm (0.06l)

Bowl for Marking Colour

Marker Blunt



Areola
Ø = 36 mm **PY-90.20**
Ø = 40 mm **PY-90.25**
Ø = 42 mm **PY-90.30**
Ø = 42 mm **PY-90.35**



GROSSMANN
PY-90.05
4 SIZES IN
40 mm,
44 mm,
48 mm,
52 mm



FREEMAN
PY-90.34 34mm/36mm
PY-90.38 38mm/42mm
PY-90.42 42mm/45mm
PY-90.46 45mm/50mm



FREEMAN
PY-90.74 34mm
PY-90.76 36mm
PY-90.78 38mm
PY-90.82 42mm
PY-90.85 45mm
PY-90.90 50mm



MCKISSOCK KEYHOLE
WITH CM MARKING
PY-36.38 38mm
PY-36.42 42mm
PY-36.45 45mm



ACKERMAN
PY-36.54 14cm/ 5½" small
PY-36.56 16cm/ 6¼" large

Breast Dissectors

Disectores mamarios

Dissecteurs mammaires

Dissettori mammari

Atraumatic breast dissector
Disector mamario atrumático
Dissecteur mammaire atraumatique
Dissettoire mammario atraumatico



PY-90.10
34 cm / 13 3/8"

PY-90.11
37 cm / 14 1/2"

Hook dissector
Disector de gancho
Crochet Dissecteur
Dissettoire a uncino

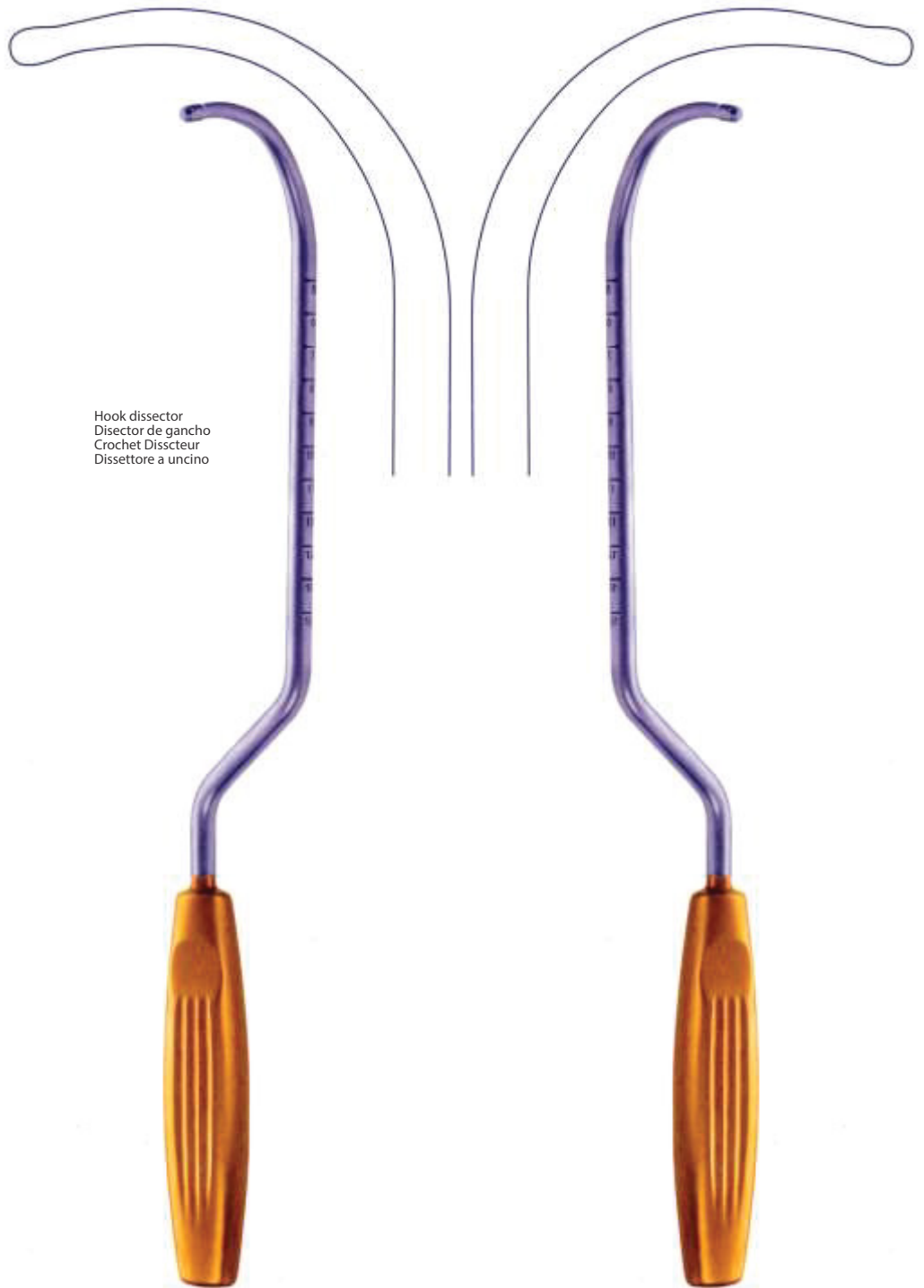

PY-90.15
36 cm / 14 1/8"
left

PY-90.16
36 cm / 14 1/8"
right

Breast Retractors

Separadores mamarios

Ecarteurs mammaires

Divaricatori mammari



MARX

Abdominal Retractor for
Lipoabdominoplasly

Separador abdominal para
la lipoabdominaoplastia

Ecarteur abdominal pour
la plastie lipo-abdominale

Divaricatore addominale per
la lipoaddominoplastica

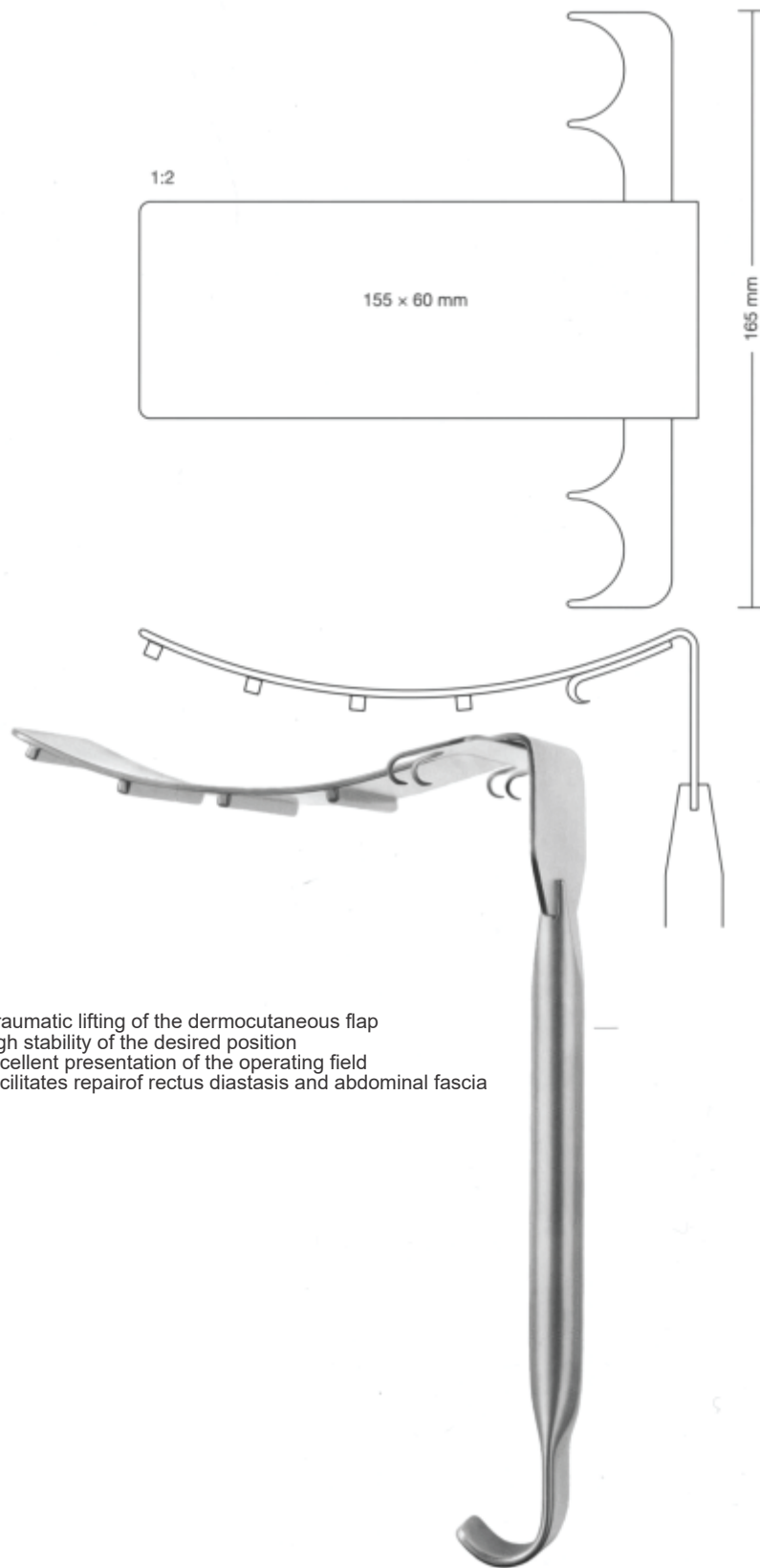

Atraumatic lifting of the dermocutaneous flap
High stability of the desired position
Excellent presentation of the operating field
Facilitates repair of rectus diastasis and abdominal fascia

SALDANHA
PY-90.50
23.5 cm / 9 1/4"

Retractor

Separadores

Ecarteurs

Divaricatori

a

b

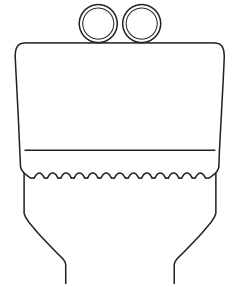
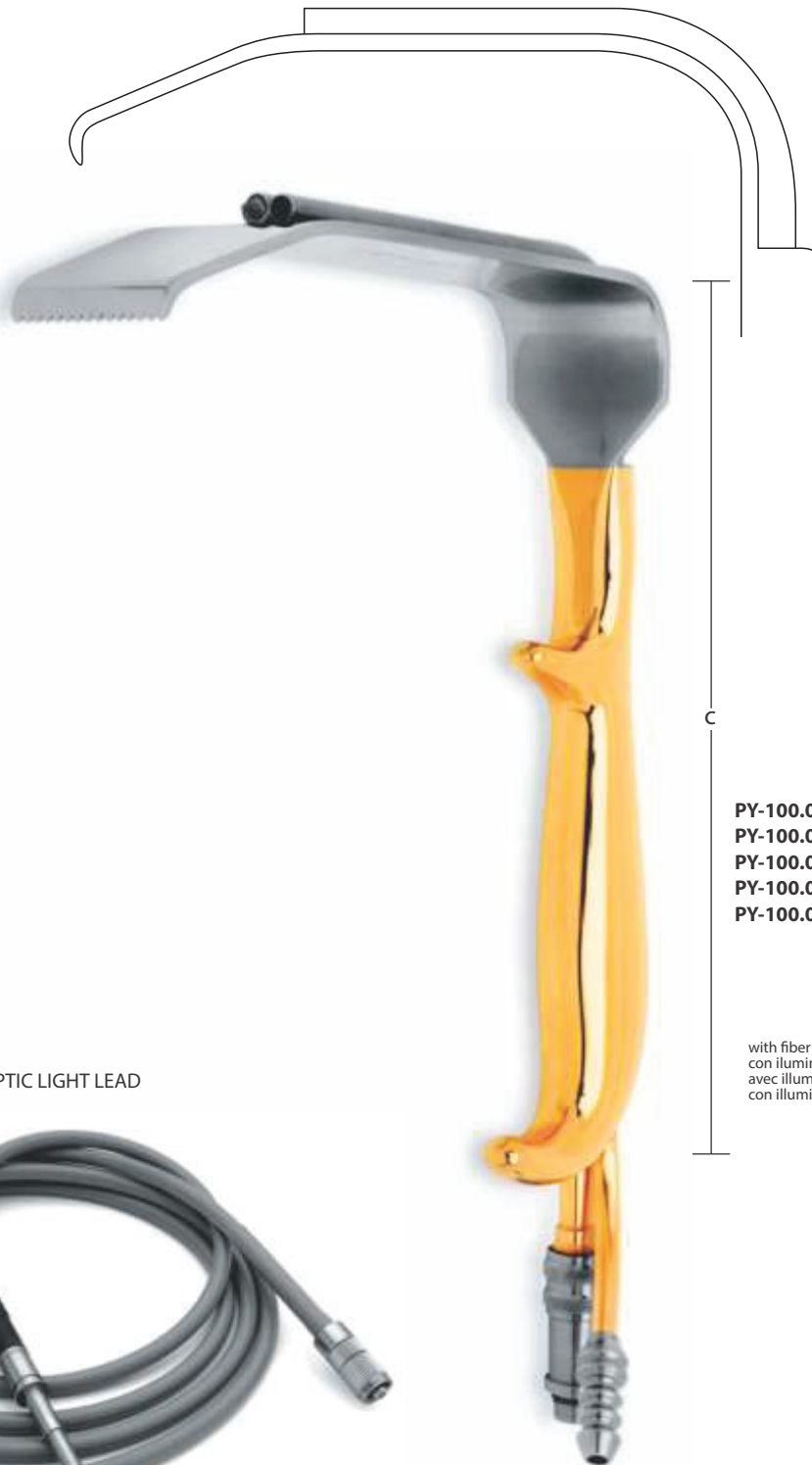

c

	a [mm]	b [mm]
PY-100.01	90	24
PY-100.02	90	30
PY-100.03	115	24
PY-100.04	150	36
PY-100.05	190	30

FIBER OPTIC LIGHT LEAD



PY-100.00

with fiber optic illumination and irrigation tube
 con iluminación de luz fría y tubo lavador
 avec illumination à lumière froide et tuyeau de lavage
 con illuminazione a luce fredda e tubo di lavaggio

TEBBETTS
 c = 18.5 cm / 7¼"

Retractor

Separadores

Ecarteurs

Divaricatori



FERRIERA
with fiber optic light illumination
and irrigation tube

	a [mm]	b [mm]
PY-100.61	70	16
PY-100.62	80	16
PY-100.63	90	27
PY-100.64	110	25
PY-100.65	120	25
PY-100.66	130	16
PY-100.67	130	25
PY-100.68	150	25
PY-100.69	150	30
PY-100.70	150	36
PY-100.71	180	16
PY-100.72	180	25
PY-100.73	190	25
PY-100.74	190	36
PY-100.75	220	27



**FERRIERA
PY-100.45**
blade width 25 x 171mm
length 13cm/5 1/8"

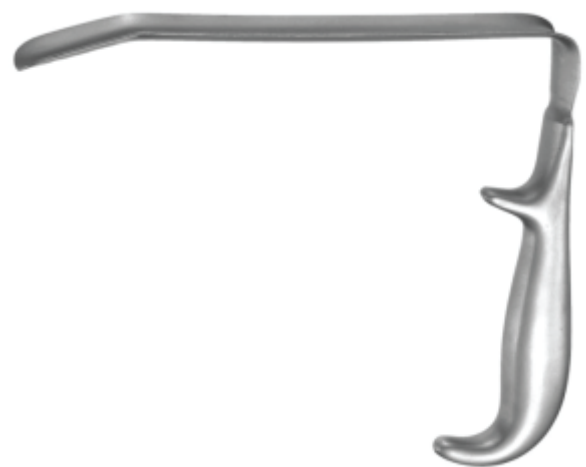

**FERRIERA
PY-100.46**
blade width 25 x 171mm
length 13cm/5 1/8"

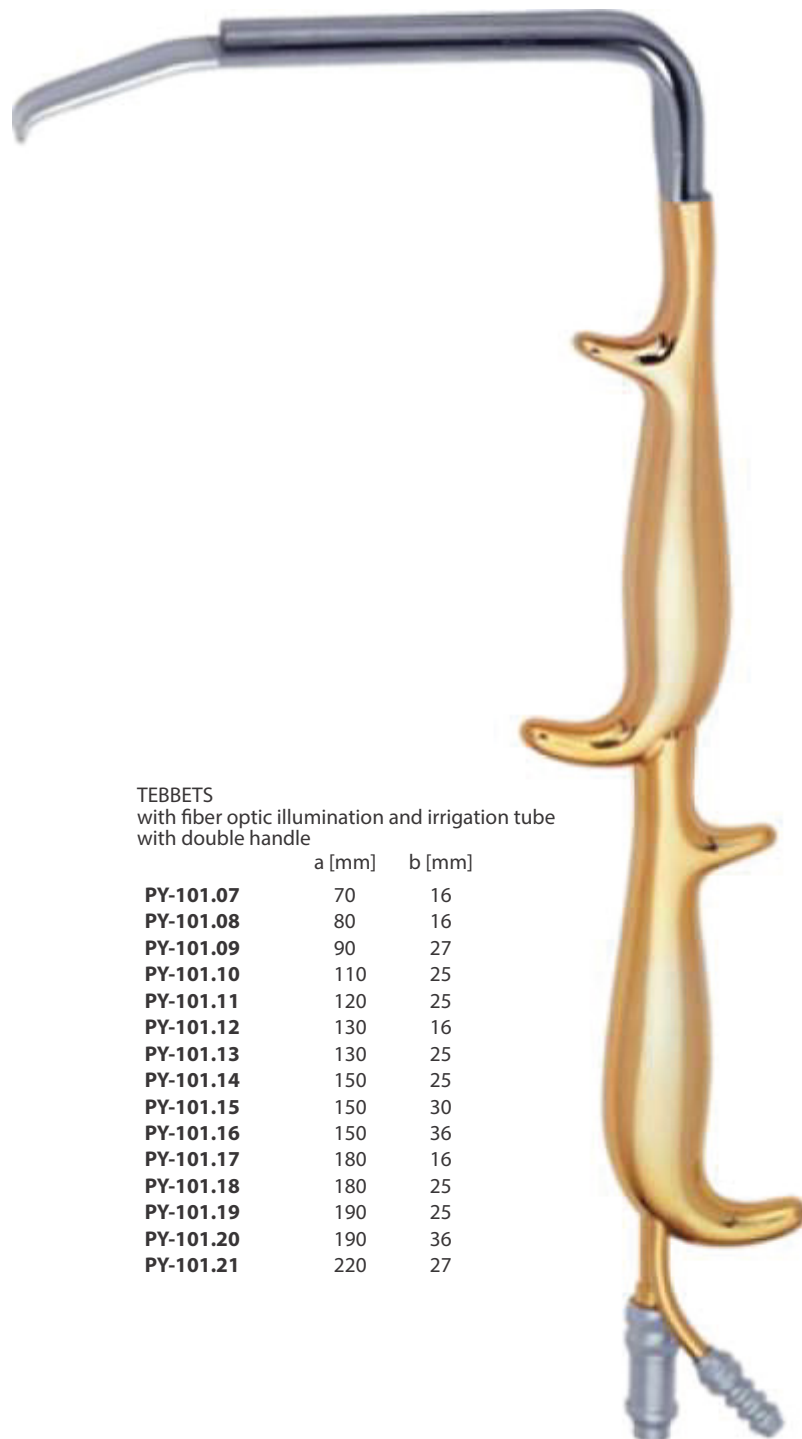

TEBBETS
with fiber optic illumination and irrigation tube
with double handle

	a [mm]	b [mm]
PY-101.07	70	16
PY-101.08	80	16
PY-101.09	90	27
PY-101.10	110	25
PY-101.11	120	25
PY-101.12	130	16
PY-101.13	130	25
PY-101.14	150	25
PY-101.15	150	30
PY-101.16	150	36
PY-101.17	180	16
PY-101.18	180	25
PY-101.19	190	25
PY-101.20	190	36
PY-101.21	220	27

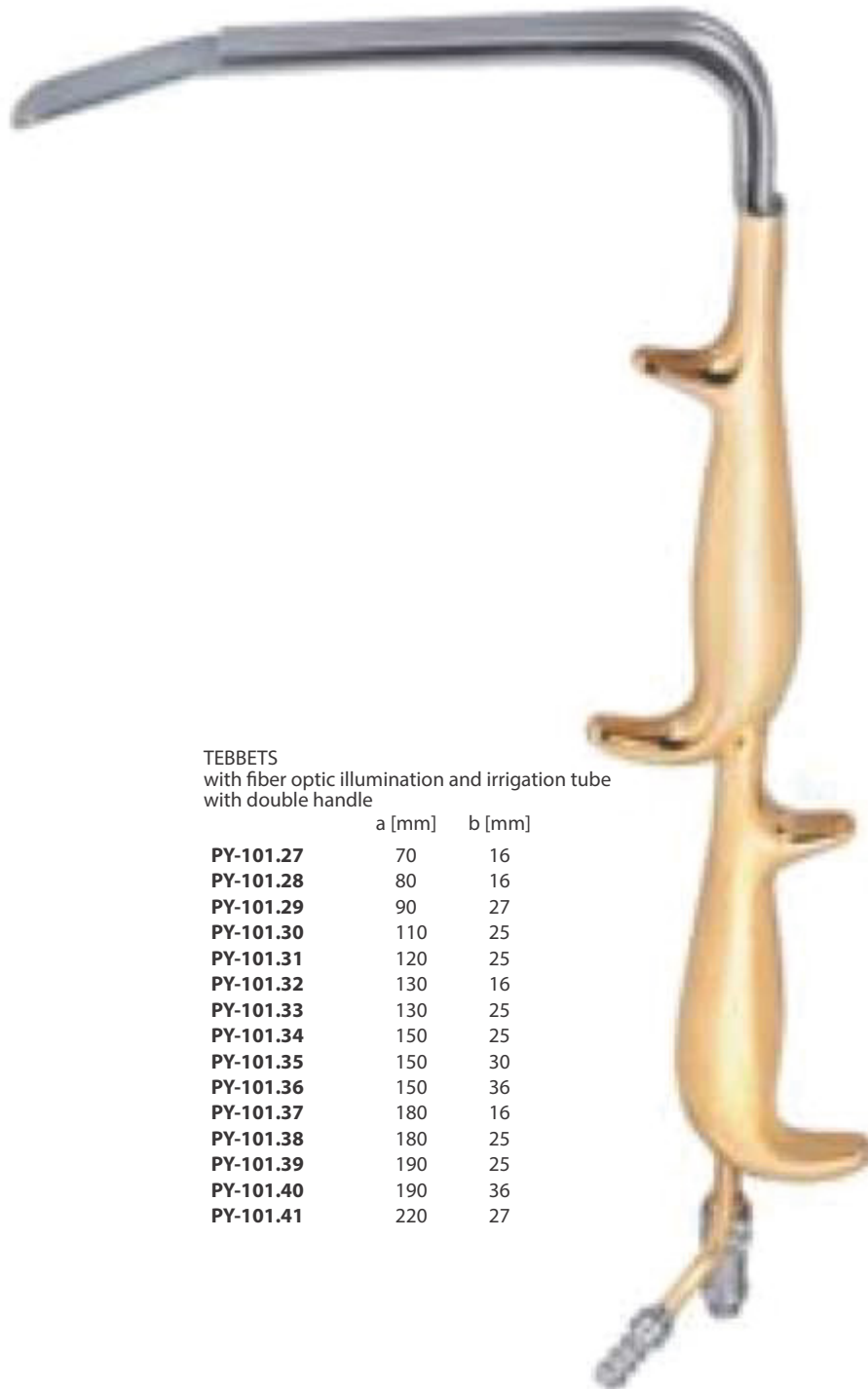

TEBBETS
with fiber optic illumination and irrigation tube
with double handle

	a [mm]	b [mm]
PY-101.27	70	16
PY-101.28	80	16
PY-101.29	90	27
PY-101.30	110	25
PY-101.31	120	25
PY-101.32	130	16
PY-101.33	130	25
PY-101.34	150	25
PY-101.35	150	30
PY-101.36	150	36
PY-101.37	180	16
PY-101.38	180	25
PY-101.39	190	25
PY-101.40	190	36
PY-101.41	220	27

Retractor

Separadores

Ecarteurs

Divaricatori



SCULPO
PY-101.55 blade size 180 x 125mm
 with 5mm endoscopic sheath
PY-101.56 blade size 180 x 125mm
 with 10mm endoscopic sheath



TEBBETS BREAST RETRACTOR
 double ended, 22 X 55mm
PAS-13.26 26 cm
PAS-13.31 31 cm



RING BREAST RETRACTOR
PY- 101.75 with fiber optic illumination
 and irrigation tube

Retractor

Separadores

Ecarteurs

Divaricatori



BIGGS MAMMAPLASTY RETRACTOR
with fiber optic light guide
PY-100.30 Narrow, 3cm blade width
15cm length
PY-100.35 5cm blade width,
20 cm length

BIGGS MAMMAPLASTY RETRACTOR
PY-100.50 5cm blade width,
20 cm length



BIGGS MAMMAPLASTY RETRACTOR
PY-100.52 Narrow, 3cm blade width
17cm length

DEAVER
PY-117.20
20cm/ 7¾"
16mm
(Insulated)

DEAVER
with fiber optic light guide
PY-117.20
20cm, Blade width 16mm

Retractor

Separadores

Ecarteurs

Divaricatori



BREAST SPATULA
serrated tip, semi malleable
PAS-13.41 25x180mm blade
31.5cm



WIEDER BREAST AND
FACIAL RETRACTOR/
TONGUE DEPRESSOR
serrated
PAS-02.21 14cm, 28mm
PAS-02.22 14cm, 38mm
PAS-02.25 15cm, 45mm



WIEDER BREAST AND
FACIAL RETRACTOR/
TONGUE DEPRESSOR
with fiber optic light guide
serrated
PAS-02.41 14cm, 28mm
PAS-02.42 14cm, 38mm
PAS-02.45 15cm, 45mm



Brow Lift Instruments

Raspatories

Legras

Rugines

Periostotomi



25 cm / 10"

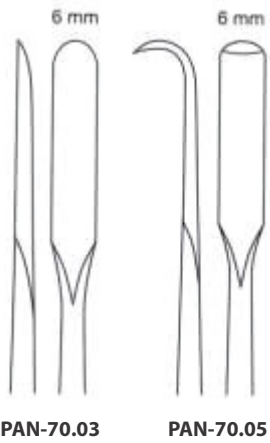

PAN-70.03

PAN-70.05

Plastic Handle
(autoclave up to 134° cat 3 bar)

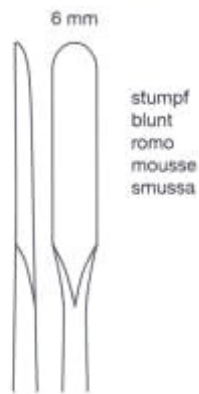

stumpf
blunt
romo
mousse
smussa



PAN-70.08
25 cm / 10"



25 cm / 10"

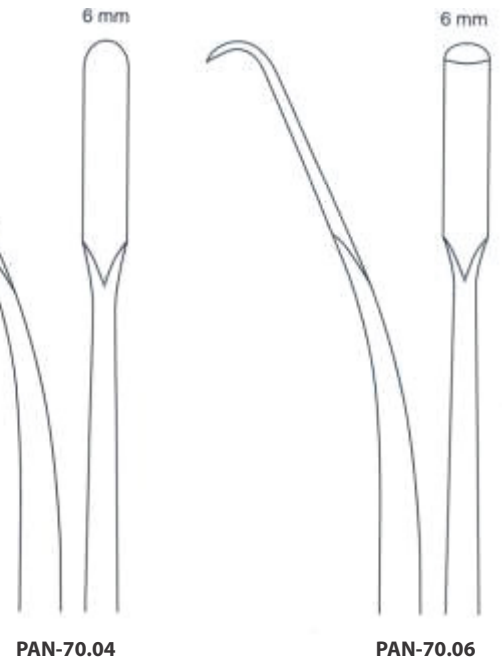

PAN-70.04

PAN-70.06



stumpf
blunt
romo
mousse
smussa



PAN-70.09
25 cm / 10"

Dissectors
Disectores
Dissecteurs
Dissettori

Elevators

Elevadores

Élévateurs

Elevatori



PAN-70.11
20 cm / 8"



PAN-70.12
20 cm / 8"



9 mm

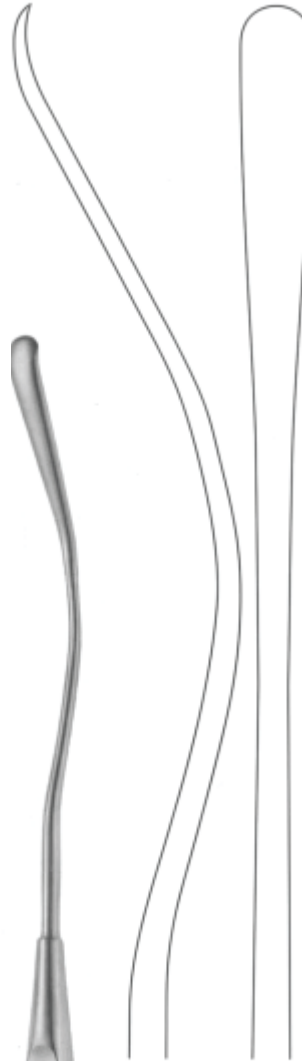

9 mm



Ligature
Needle



a = 7 cm - 2¾"
PAN-75.07



a = 12 cm - 4¾"
PAN-75.12

ENTNER



Elevators
Elevadores
Élévateurs
Elevatori

PAN-70.43
27 cm / 10¾"



PAN-70.45
27.5 cm / 10¾"

Elevators

Elevadores

Élévateurs

Elevatori



PAN-70.47
27.5 cm / 10¾"

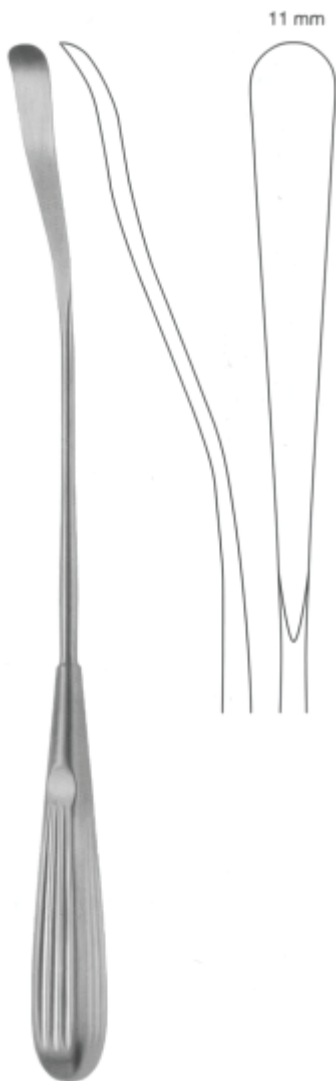

PAN-70.49
27.5 cm / 10¾"

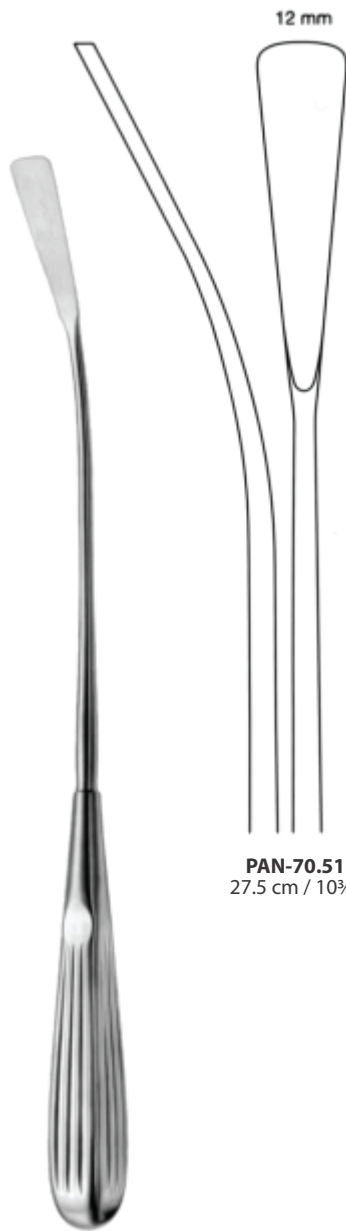

PAN-70.51
27.5 cm / 10¾"

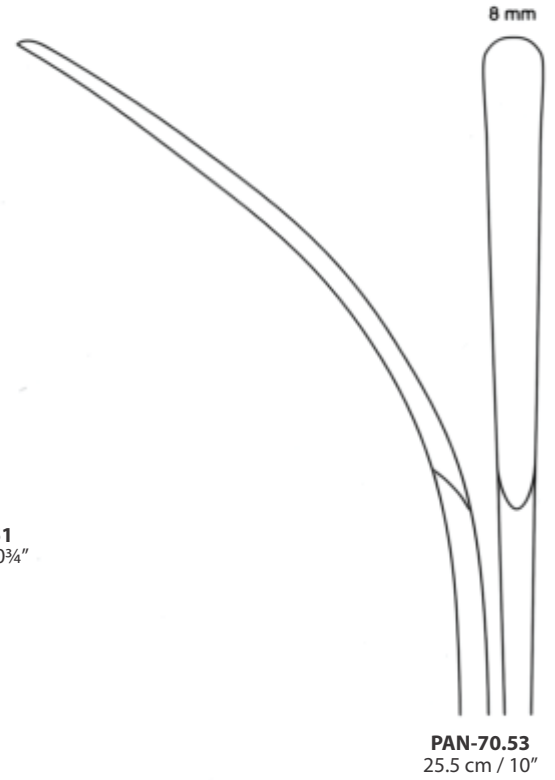

PAN-70.53
25.5 cm / 10"

Elevators

Elevadores

Elévateurs

Elevatori



PAN-70.54
28 cm / 11"



PAN-70.55
27 cm / 10¾"

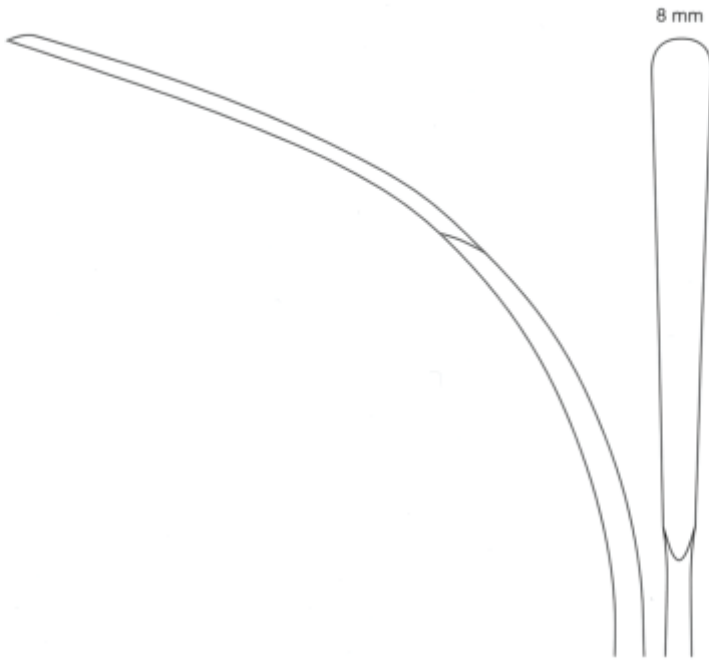

PAN-70.57
24 cm / 9½"



PAN-70.59
27.5 cm / 10¾"



PAN-33.56
26 cm / 10¼"
half curved
tip 8mm

Tubing connector
Empalme de tubo
Embout de tuyaux
Attacco di tubo

Elevators

Elevadores

Élévateurs

Elevatori



PAN-70.20
Endoforehead Elevator
Half curved 7mm wide
24cm/ 9½"

PAN-70.23
Transoral Dissector
curved 7mm wide
23.5cm/ 9¼"

PAN-70.24
Orbital Rim Dissector
Half curved
24cm/ 9½"

PAN-71.24
Frontotemporal Dissector
straight 10mm wide
22.5cm/ 8¾"

For initial dissection
through forehead incisions



PAN-71.34
 Frontotemporal Dissector
 curved 7mm wide
 24cm
 For initial dissection

PAN-71.25
 Periosteal Dissector
 curved 9mm wide
 25cm/ 9¾"
 For a posterior
 scalp dissection

PAN-71.31
 Periosteal Dissector/
 Elevator
 s-shaped 9mm wide
 24cm/ 9½"
 For elevation of the
 periosteum

PAN-71.84
 Scalp Elevator
 straight 7mm wide
 24cm/ 9½"

Elevators

Elevadores

Élévateurs

Elevatori



PAN-71.32
Flap Dissector
Curved 6mm wide
22.5 cm/ 8¾"



PAN-71.36
Frontotemporal Dissector
s-shaped 7mm wide
26cm



PAN-71.63
Temporal Line Dissector
10mm wide
23.5cm



PAN-71.82
Zygomatic Arch Elevator
5mm wide
22.5cm



PAN-71.54
Scalp Elevator
Half curved with
angled tip
12mm wide
24cm

Elevators

Elevadores

Elévateurs

Elevatori



PAN-71.34
Arcus Marginalis Dissector
S-shaped 8mm wide
24cm



PAN-71.77
Nerve Retractor
curved left
17cm



PAN-91.63 33cm
PAN-91.70 44.5cm
TBTS-Style
Anglated Breast Dissector
Long Pattern



PAN-91.36 36cm
PAN-91.40 44.5 cm
TBTS-Style Spatulated
Breast Dissector

Grasping Forcepsn
and Hook scissors

Pinzas para agarrar y
tijeras de gancho

Pinces à saisir et
ciseaux à crochet

Pinze per afferrare
e forbici a gancio

Hook scissors
Tijeras de gancho
Ciseaux à crochet
Forbici a gancio

12 cm - 4¾"

curved left
curva izquierdo
courbes à gauche
curva sinistra

curved right
curva derecho
courbes à droite
curva destra



PAN-70.15

PAN-70.16



12 cm - 4¾"

Grasping forceps
Pinzas para agarrar
Pinces à saisir
Pinze per afferrare

curved left
curva izquierdo
courbes à gauche
curva sinistra

curved right
curva derecho
courbes à droite
curva destra



PAN-70.17

PAN-70.18



INDEX

A		Bulldog clamps	048
Abdominal retractor	095	Bulldog scissors	026
ACKERMAN	164	C	
ADSON Delicate forceps dressing and tissue	040	Calipers	003
ADSON Delicate forceps, tissue	041	CAPLAN Nasal septum scissors	030
ADSON Delicate retractors	085	Cartilage abraders	121
ADSON-BROWN Delicate forceps	041	Cartilage crushers	104
ADSON-GRAEFE Delicate forceps,	042	Cartilage cutting block	104
ADSON-TOENNIS Dissecting Scissors	015	Cartilage instruments	103,104
AIACH Forceps	109	Cartilage scissors	029
Alar hooks	115	CASTROVIEJO Calipers	003
Alar retractors	115	CASTROVIEJO-EPKER Calipers	003
ALM Self-retaining retractors	092	Channel retractors	102
Arcus Marginalis Dissector	183	Chin retractor	102
Areola marker	164	Chisels	71-79
ASCH Septum straightening forceps	127	Cinelli Osteotomes	78
Atraumatic breast dissector	165	CINELLI Rhinoplasty scissors	026
AUFRICHT Nasal rasps	122	CLAUS-KILLIAN Septum gouges	072
AUFRICHT Nasal Retractors	116,117,118	Cleft palate hooks	106
AUFRICHT Rhinoplasty scissors	029	Cleft palate raspatories	105
AUFRICHT-WALTER Nasal retractors	116	CLODIUS FISH HOOK RETRACTOR	089
B		COHEN Elevators	064
BABY-FARABEUF Retractors	090	COLLIER Needle holders	052
BABY-METZENBAUM Delicate scissors	011,012	Columella forceps	114
BALLENGER Chisels	072	CONVERSE BLADE NASAL RETRACTOR	118
BARBON-LUBET Nasal dressing forceps	112	CONVERSE Nasal file	123
BARSKY Skin hooks	086	CONVERSE Nasal retractors	117
BENICKE Delicate retractors	087	CONVERSE Needle holders	052
BERGMANN Delicate retractors	087	CONVERSE Raspatories	066
BIGGS MAMMAPLASTY RETRACTOR	173	CONVERSE Rhinoplasty knives	119
BLAKESLEY Nasal forceps	125-126	CONVERSE Rhinoplasty scissors	026
BLAKESLEY-WEIL Ethmoid bone forceps	125-126	CONVERSE-DERF Needle holders	053
BLAKESLEY-WEIL Nasal forceps	125-126	COPE Delicate retractors	084
Blepharoplasty scissors	023	COPE-WALTER Nasal retractors	084
BLOCKSMA Cleft palate hooks	106	COTTLE Alar and skin hooks	087
BLUME Osteotomes	078	COTTLE Alar retractors	116
BOIES Nasal fracture elevator	066	COTTLE Bone lever and splitting Osteotome	74
Bone bending pliers	103	COTTLE Bulldog scissors	027
Bone bow spacer	003	COTTLE Cartilage crushers	104
Bone instruments	103,104	COTTLE Chisels	112
Bone lever	074	COTTLE Chisels	112-113
Bone mill	104	COTTLE Delicate retractors	071
Bowl for marking colour	164	COTTLE Elevators	067
BOZEMANN (WERTHEIM) Needle holders	056	COTTLE Mallets	062
Breast dissectors	165	COTTLE Nasal rasps	120
Breast elevator	164	COTTLE Nasal retractors	115
Breast retractors	166	COTTLE Nasal septum scissors	030
BREAST SPATULA	174	COTTLE Nasal septum speculum	113,114
BROWN-ADSON Delicate forceps	041,042	COTTLE Nasal specula	113
BRUENINGS-LUC (HEYMANN) Nasal septum forceps	124	COTTLE Osteotomes	112,113
BRUESER-KELLY Delicate dissecting scissors	017	COTTLE Raspatories	119

COTTLE Rhinoplasty knives	119	FANOUS Dissecting Scissors	006
COTTLE Rhinoplasty scissors	027-028	FANOUS Osteotomes	113
COTTLE Septum elevators	120	FANOUS Rhinoplasty Scissors	025
COTTLE Tissue grasping forceps	045	FANOUS Undermining scissors	017
COTTLE Tunnelling elevator	068	FARABEUF Retractors	090
COTTLE-FOMON Septum forceps	127	FARABEUF-BABY Retractors	092
COTTLE-MASING Mucosa needle holders	058	FERRIERA Retractors	083
COTTLE-MASING Rhinoplasty scissors	027	Finger goniometer	002
COTTLE-McKENTY Raspatories	121	FINSEN Self-retraining retractors	089
COTTLE-NEIVERT Nasal retractors	104	Fistula hook	085
COTTLE-WALTER Rhinoplasty scissors	027	Fixation wire with needles	109
CRAIG Vomer forceps	104	Flexometer	002
CRAIG-DOMNICK Vomer forceps	104	FOMON COTTLE Septum forceps	115
CRILE Delicate retractors	094	FOMON Nasal rasps	120
CRILE-WOOD Needle holders	054	FOMON Nasal Retractors	115
Cylinder osteotomes	082	FOMON Osteotomes	074
		FOMON Rhinoplasty scissors	25-29
		Forceps, dressing and tissue	040-044
		FOWLER Mallets	062
		FOX Gum scissors	024
		FOX Tissue grasping forceps	045
		FOX Tissue holding forceps	045
		FRAZIER Dura and skin hooks	085
		FREEMAN Arolal Makers	164
		FREEMAN FACE LIFT Retractors	094
		FREEMAN FACE Retractors	094
		FREEMAN FLAP Retractors	094
		FREEMAN SKIN HOOK	089
		FREEMAN-GORNEY Dissecting Scissors	021
		FREEMAN-METZENBAUM Dissecting Scissors	016
		FREER Chisels	072
		FREER Elevators	063,064
		FREER Mucosa knife	072
		FREER Retractors	070
		FREER-OBWEGESER Raspatories	070
		Frontotemporal Dissector	180
		G	
		GILLIES Delicate Retractors	085
		GILLIES Delicates forceps, Dressing and tissue	043
		GILLIES Needle Holders	057
		GILLIES-OBWEGESER Needle Holders	057
		GILLIES-SLIM Needle holders	057
		GIUNTA Rhinoplasty scissors	026
		GOLDMAN Septum fracture elevator	066
		GORNEY Dissecting scissors	021
		GORNEY RAKE RETRACTOR	094
		GORNEY-FREEMAN Dissecting Scissors	021
		GRAEFE-ADSON Delicate forceps,	042
		GREENBERG PAR delicate dissecting Scissors	018
		GREEN-LANGENBECK Delicate Retractors	084
		GREEN-SENN Delicate retractors	084
D			
D ASSUMPCAO Marker	004		
DEAN Gum scissors	026		
DEAVER	173		
DEBAKEY Tissue grasping forceps	043		
Delicate dissecting scissors	006-022		
Delicate forceps, dressing and tissue	040-044		
Delicate forceps, tissue	045		
Delicate retractors	069,070-076		
Delicate scissors	006-008		
DENHART Mouth gags	110		
DERF-CONVERSE Needle holders	053		
Dermatomes	038		
DESMARRES Lid retractors	098		
DIETHRICH Hemostatic forceps	048		
DINGMANN Cartilage abraders	121		
DINGMANN Mouth gags	110		
DINGMANN Raspatories	176		
Dissecting scissors	006-022		
Dissectors	165		
DOMNICK-CRAIG Vomer forceps	124		
Dressing and tissue Grasping forceps	045		
E			
Elevators	063-065, 119-120, 133		
Elevators	063-064		
EMMET Fistula hook	071		
ENTNER Ligature needles	133		
EPKER-CASTROVIEJO Calipers	003		
Ethmoid bone forceps	125		
EWALD-HUDSON Delicate forceps	040		
F			
Facelift marker	004		

GROSSMANN Arola Markers	164	KILNER Alar retractors	116
GRUBER COLUMELLA RETRACTOR	089	KISTLER Anthelix cartilage file	121
GRUENWALD bayonet forceps	044	KLEINERT-KUTZ Skin hooks	086
H		KNAPP Delicate dissecting scissors	008-009
HALSEY Needle holders	053	Knife inserts	119
HALSTED-MOSQUITO Hemostatic Forceps	048	Knives	119
HARGIS Raspatories	069	KOCHER Retractors	091
HARTMANN Nasal dressing forceps	112	KRETSCHMER Reference pin	004
HARTMANN Nasal specula	113	KUTZ-KLEINERT Skin hooks	086
Hemostatic forceps	047-050	L	
HEYMANN Nasal septum forceps	124	LAHEY-CLINICH Dura and skin hooks	088
HEYMANN Rhinoplasty scissors	026	LANGENBECK Elevators	063
Hook dissector	165	LANGENBECK-GREEN Delicate Retractors	085
Hook scissors	184	LEMPERT Raspatories	064
HOSPITAL-PROVIDENCE Hemostatic Forceps	050	LERICHE Hemostatic forceps	050
HUDSON-EWALD Delicate Forceps	040	LEWIS Nasal rasps	120
HUMBY Delicate Retractors	087	LEXER Dissecting scissors	011
HUMBY Dermatomes	038	LEXER-BABY Delicate dissecting Scissors	008
I		LEXER-MAYO Dissecting scissors	008
Iliac crest retractors	096	Lid grasping forceps	045
Interdental osteotomes	079	Lid retractors	098
Iris scissors	007	Ligature needles	177
J		Lip instruments	105-108
JACKSON Tracheal hooks	086	LITTAUER Stitch scissors	024
JACOBSON-MICRO Hemostatic Forceps	049	LITTLER Suture carrying scissors	022
JAMESON Calipers	002	LOCKWOOD Marker	004
JAMESON Delicate dissecting scissors	020	LUBET-BARBON Nasal dressing Forceps	112
JOSEPH Calipers	002	LUC-BRUENINGS (HEYMANN) Nasal Septum forceps	124
JOSEPH Delicate dissecting scissors	018	M	
JOSEPH Delicate retractors	086	MALINIAC NASAL RETRACTOR	118
JOSEPH Nasal saws	119	Mallets	062
JOSEPH Nose Tip Marker	004	MALTZ Nasal rasps	120
JOSEPH Rhinoplasty knives	119	MAMMAPLASTY ORMASTECTOMY HOOK	089
JOSEPH Rulers	002	Mandibular rim retractor	098
JOSEPH Septum cartilage knife	119	Marking instruments	002-004
JOSEPH-MASING Septum raspatory	066	MARTEN Flap Marker	004
JOSEPH-PECK Delicate dissecting Scissors	019	MARX Breast retractors	166
K		MASING Alar retractors	115
KAHRE Cleft palate raspatories	106	MASING Nasal rasps	123
KAYE Blepharoplasty scissors	023	MASING Septum elevators	067
KAYE Dissecting scissors	022	MASING-COTTLE Mucosa needle Holders	058
KELLY Dissecting scissors	017	MASING-COTTLE Rhinoplasty scissors	028
KELLY Stich scissors	024	MASING-JOSEPH Septum raspatory	066
KELLY-BRÜSER Delicate dissecting Scissors	017	MATHIEU Needle holders	058
KILLIAN Nasal specula	113,114	MAYO Dissecting scissors	010
KILLIAN Septum gouges	072	MAYO-HEGAR Needle holders	055
KILLIAN SPECULUM	113	MAYO-LEXER Dissecting scissors	011
KILLIAN-CLAUS Septum gouges	072	McINDOE Cartilage scissors	029
		McINDOE Chisels	076
		McINDOE Cleft palate raspatories	106

McINDOE Delicate forceps, Dressing and tissue	042	NEIVERT Needle holders	052
McKENTY Raspatories	063	NEIVERT-COTTLE Nasal retractors	115
McKENTY-COTTLE Raspatories	068	NELSON Tissue grasping forceps	043
MCKISSOCK KEYHOLE	164	NELSON-METZENBAUM Dissecting Scissors	013-014
Measuring instruments	002-003	Nerve Retractor	183
MERSON Wire positioner	109	NEWS Tracheal hooks	087
METZENBAUM Dissecting Scissors	011-012	NIRO Wire twisting forceps	109
METZENBAUM-BABY Delicate scissors	011	Nose tip marker	004
METZENBAUM-FREEMANN Dissecting Scissors	016		
METZENBAUM-NELSON Dissecting Scissors	013-014	O	
METZENBAUM-SLIM Dissecting Scissors	015-016	O'BRIEN Stitch scissors	025
MEYERDING Delicate retractors	088	OBWEGESER Bone bending pliers	103
Micro Needle holders	059	OBWEGESER Channel retractors	102
MICRO-ADSON Delicate forceps	041	OBWEGESER Chin retractors	102
MICRO-HALSTED Hemostatic forceps	049	OBWEGESER Interdental osteotomes	079
MICRO-IRIS Iris scissors	007	OBWEGESER iliac crest retractors	096
MICRO-JACOBSON hemostatic Forceps	049	OBWEGESER Mandibular rim retractor	098
MILLARD (COTTLE) Nasal retractors	115	OBWEGESER Maxilla mobilizer	081
MILLARD THUMB HOOK	089	OBWEGESER Nasal rasps	122
MILLAR-SENN Delicate retractors	084	OBWEGESER Nasal ridge scissors	030
MINI-METZENBAUM Delicate scissors	013	OBWEGESER Nasal septum Osteotomes	081
MOBERG Chisels	076	OBWEGESER Nasal spine retractor	101
MOD. WIEN Nasal specula	114	OBWEGESER osteotomes	076,077,079
MOLT mouth gags	110	OBWEGESER Pterygoid osteotomes	080
MÖLTGEN Flexometer	002	OBWEGESER Ramus retractors	098
MOSQUITO Hemostatic forceps	048	OBWEGESER Raspatories	065,069
MOSQUITO-HALSTED Hemostatic Forceps	049	OBWEGESER Septum forceps	128
Mouth Gags	110	OBWEGESER Soft tissue retractors	099-100
Mucoperiost retractors	107	OBWEGESER Splitting osteotomes	079
Mucosa knife	072	OBWEGESER Wedge osteotomes	079
Mucosa needle holders	058	OBWEGESER Wire loop forceps	109
		OBWEGESER Wire twister	109
N		OBWEGESER Wisdom tooth retractor	101
Nasal dressing forceps	112	OBWEGESER-FREER Raspatories	070
Nasal file	123	OBWEGESER-GILLIES Needle Holders	057
Nasal forceps	125-126	Orbital rim dissectors	180
Nasal fracture elevator	066	Osteotomes	074-082
Nasal rasps	120-123		
Nasal retractors	115-118	P	
Nasal ridge scissors	030	PECK-JOSEPH Delicate Dissecting scissors	019
Nasal saws	119	Pen holder	003
Nasal septum forceps	124	Pen Holder	003
Nasal septum osteotomes	081	PEN	003
Nasal septum scissors	030	PENNINGTON Elevators	072
Nasal septum speculum	113	PITANGUY facelift marker	004
Nasal specula	113-114	PROVIDENCE-HOSPITAL Hemostatic Forceps	050
Nasal spine retractor	101	Pterygoid osteotome	080
Navel Marker	097		
Needle holders with scissors	057	R	
Needle holders	051-058	RAGNELL (KILNER) Delicate Dissecting scissors	017
Needle holders	051-058	RAGNELL Delicate retractor	084
NEIVERT Nasal retractors	115	Ramus retractors	098

Raspatories	064-066,068-070,176	STILLE-MAYO Dissecting scissors	010
Reference pin	004	STILLE-STRANDELL Delicate Retractors	085
Retractor with fiber optic illumination	090,117,168-171,173,174	Stitch scissors	024
Retractors	092-102	STRAIGHT Dura and skin hooks	086
REYNOLDS (JAMESON) Dissecting Scissors	020	Suction elevator	067
Rhinoplasty knives	119	Suturing forceps	044
Rhinoplasty scissors	025-030		
Rib raspatories	065	T	
RING BREAST RETRACTOR	172	TBTS-Style Anglated Breast Dissector	183
ROSER KOENIG Mouth gags	110	TBTS-Style Spatulated	183
RUBIN Chisels	076	TEBBETTS Retractors	168
RUBIN Osteotomes	074	Temporal Line Dissector	180
RUBIN Septal morselizer Forceps	103	TESSIER Osteotomes	070
Rulers	002	TESSIER Raspatories	080
		THOMSON-WALKER (BOZEMANN) Needle holder	056
S		THORPE Calipers	002
SALDANHA Abdominal Retractors	095	TIECK-HALLE Nasal specula	113
Scalpel blades	034	Tissue grasping forceps	045
Scalpel handles	034-036	Tissue holding forceps	045
SCHINK Dermatomes	038	TOENNIS-ADSON Dissecting scissors	015
SCHROM Osteotomes	075	Tongue depressor	174,108
Scissors	005-032	Tracheal hooks	086
SCULPO Retractors	172	Trocars	082
Sculpture knives	037	TROELTSCH (WILDE) Tissue grasping Forceps	044
Sculpture knives	037	Tunnelling raspatory	068
Self-retaining retractors	092-093		
SEMKEN delicate forceps	042	U	
SENN-GREEN Delicate retractors	084	Undermining scissors	017,021
SENNING Needle holder	056	UNIV. MINNESOTA Cheek retractors	108
SENN-MILLER Delicate retractors	084	UNIVERSAL Wire cutting scissors	025
Septal morselizer forceps	103		
Septum cartilage knives	119	V	
Septum forceps	127	Vomer forceps	124
Septum fracture elevator	066		
Septum gouges	072	W	
Septum straightening forceps	127-128	WALKER-THOMSON (BOZEMANN) Needle holder	056
Sheen Grid	003	WALSHAM "UNIVERSAL" Septum Forceps	127
Sheen Grid	003	WALSHAM Septum straightening Forceps	127
SHEPARD Cylinder osteotomes	082	WALTER Lid grasping forceps	043
SIEGERT Undermining scissors	017	WALTER Osteotomes	074
SILVER Dermatomes	038	WALTER Raspatories	064
SILVER Osteotomes	078	WALTER Retractors	084
Skin hooks	086	WALTER Rhinoplasty scissors	027
SLIM Delicate dissecting scissors	019	WALTER Tissue grasping forceps	043
SLIM-GILLIES Needle holders	057	WALTER-AUFRICHT Nasal retractors	116
SLIM-METZENBAUM Dissecting Scissors	014-015	WALTER-COPE Nasal retractors	084
SPENCER Stitch scissors	024	WALTER-COTTLE Rhinoplasty scissors	027
Splitting osteotome	074	WALTER-WILLIGER Curette	064
STERNBERG Cheek retractors	108	WANG Lip and cleft palate Instruments	105
STEVENS Iris scissors	007	WANG Mouth gags	110
STEVENS Delicate dissecting Scissors	007	WATSON Dermatomes	038
		WATSON Forceps, dressing and tissue	043

Wedge osteotomes	079
WEIL-BALKESLEY Ethmoid bone Forceps	125
WEIL-BLAKESLEY Nasal forceps	126
WEITLANER Self-retaining retractors	093
WESTMACOTT Nasal dressing Forceps	112
WIEDER BREAST AND FACIAL RETRACTOR	174
WILLIGER Raspatories	063
WILLIGER-WALTER Curette	064
Wire cutting scissors	025
Wire Instruments	109
Wire loop forceps	109
Wire pusher	109
Wire twister	109
Wire twisting forceps	109
Wires	109
Wisdom tooth retractor	101
WRIGTH (DERF) Needle holders	053
Y	
YANCOSKIE ABDOMINOPLASTY Retractors	094
YANCOSKIE CORONAL Retractors	094
YANKAUER Septum elevator	066
Z	
Zygomatic Arch Elevator	182

Professional

Envision Life

Professional Hospital Furnishers

A faint, light blue world map is centered in the background of the page, showing the outlines of continents and oceans.

19-A (N), Industrial Estate, Sialkot-51310, Pakistan.

Tel. +92 52 355 8074, 325 6440
Email: info@phfworld.com

www.phfworld.com