

Professional
Envision Life



Neurosurgery *Instruments*

Neurochirurgische Instrumente
Instruments de neurochirurgie
Instrumentos de neurocirugía
Strumenti per neurochirurgia



Page No.

Standard/Delicate

- Non-detachable KERRISON punches



002

Detachable

- Detachable KERRISON punches



006

Non Glare

- Coated KERRISON punches



014

Special

- Curved KERRISON punches



017

Special

- Bayonet-shaped KERRISON punches



017

Special

- Bayonet-shaped KERRISON punches
left side angled



018

Rongeurs for spine surgery

- Detachable / Non-detachable



019

Standard

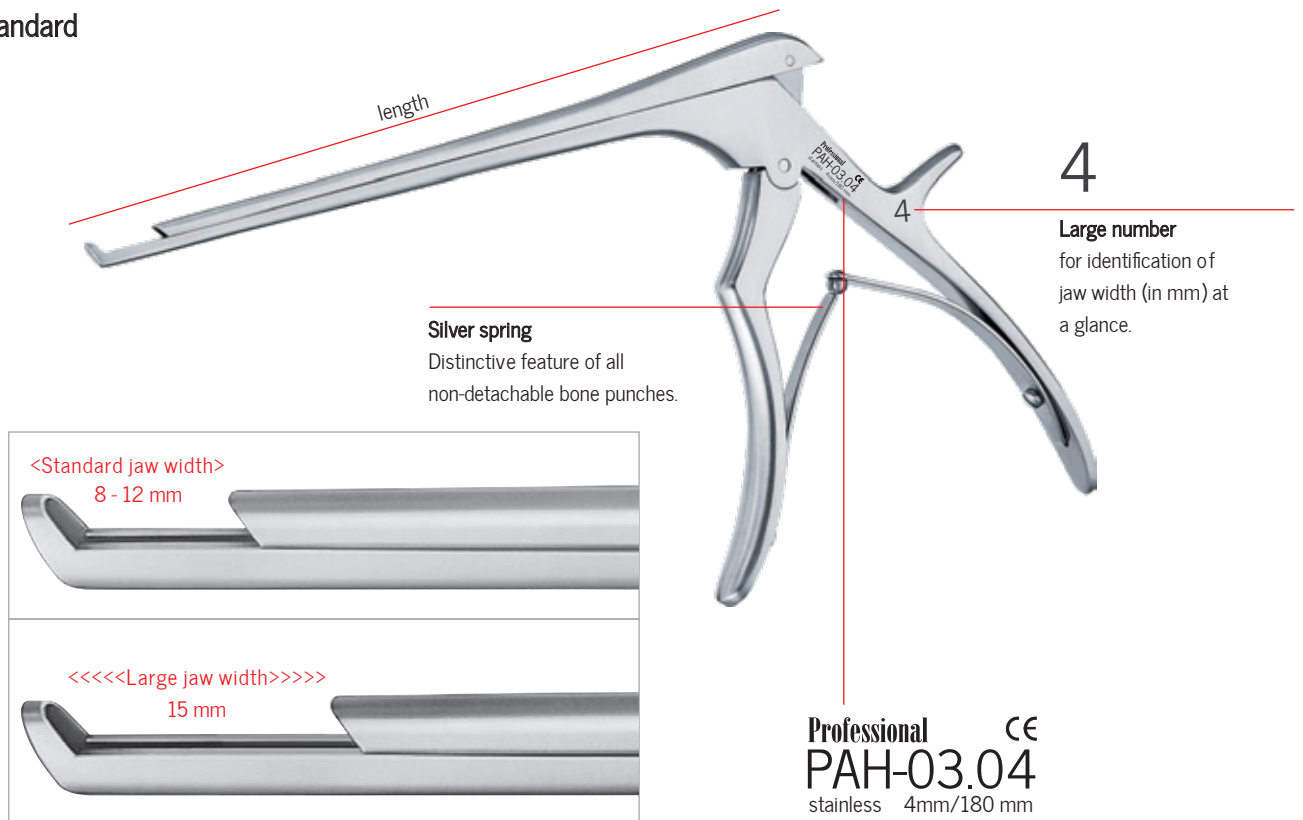













Standard

Lengths - 180 mm









Width (mm)		upward	downward	130° upward	130° downward	Jaw Width
10	□	PAH-03.01	PAH-03.11	PAH-03.21	PAH-03.31	8 mm
15	□			PAH-101.03		15 mm
20	□	PAH-03.02	PAH-03.12	PAH-03.22	PAH-03.32	9 mm
				PAH-101.05		15 mm
25	□			PAH-101.06		10 mm
				PAH-101.07		15 mm
30	□	PAH-03.03	PAH-03.13	PAH-03.23	PAH-03.33	10 mm
				PAH-101.09		15 mm
40	□	PAH-03.04	PAH-03.14	PAH-03.24	PAH-03.34	12 mm
				PAH-101.11		15 mm
50	□	PAH-03.05	PAH-03.15	PAH-03.25	PAH-03.35	12 mm
				PAH-101.13		15 mm
60	□	PAH-03.06	PAH-03.16	PAH-03.26	PAH-03.36	12 mm
				PAH-101.15		15 mm

Standard

Lengths - 200 mm

Width (mm)	upward	downward	130° upward	130° downward	Jaw Width
					
1.0			-		-
1.5			PAH-102.02		9 mm
2.0			PAH-102.04		9 mm
			PAH-102.05		15 mm
2.5			PAH-102.06		10 mm
3.0			PAH-102.08		10 mm
			PAH-102.09		15 mm
4.0			PAH-102.10		12 mm
			PAH-102.11		15 mm
5.0			PAH-102.12		12 mm
			PAH-102.13		15 mm
6.0			PAH-102.14		12 mm
			PAH-102.15		15 mm

Lengths - 230 mm

1.0			-	-	-
1.5			-	-	-
2.0			PAH-103.02	PAH-103.42	9 mm
2.5			-	-	-
3.0			PAH-103.08	PAH-103.48	10 mm
4.0			PAH-103.10	PAH-103.50	12 mm
5.0			PAH-103.12	PAH-103.52	12 mm
6.0			-	-	-

Delicate

Thin footplate

These Kerrison punches feature a distinctive golden distal end.



Large jaw punches

offer a 65% wider jaw opening compared to standard punches.

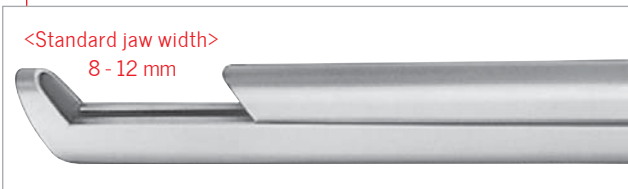

Thin

for delicate use only

Punches with a thin footplate are used exclusively for removing small portions of bone and soft tissue

for delicate use only

4

Large number for identification of jaw width (in mm) at a glance.

Silver spring

Distinctive feature of all non-detachable bone punches.

Professional ^{CE}
PAH-111.04
stainless 4mm/180 mm

Lengths - 180 mm









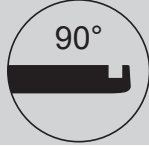
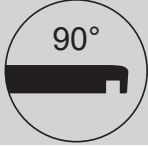
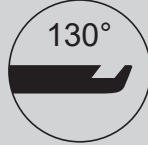

Width (mm)	upward	downward	130° upward	130° downward	Jaw Width
10					8 mm
15					9 mm
20					9 mm
25					10 mm
30					10 mm
40					12 mm
50					12 mm

Lengths - 200 mm

10					8 mm
15					9 mm
20					9 mm
25					10 mm
30					10 mm
40					12 mm
50					12 mm

Thin

Lengths - 230 mm

Width (mm)	upward	downward	130° upward	130° downward	Jaw Width
					
2.0 			PAH-113.02	PAH-113.42	9 mm
3.0 			PAH-113.08	PAH-113.48	10 mm
4.0 			PAH-113.10	PAH-113.50	12 mm
5.0 			PAH-113.12	PAH-113.52	12 mm
Lengths - 280 mm					
2.0 			PAH-114.02		9 mm
3.0 			PAH-114.08		10 mm
4.0 			PAH-114.10		12 mm
5.0 			PAH-114.12		12 mm

Detachable

- Easy disassembly and assembly
- Efficient cleaning and sterilization
- Nothing can be lost

for delicate use only

Punches with a thin footplate are used exclusively for removing small portions of bone and soft tissue

1.5

Large number for identification of jaw width (in mm) at a glance.

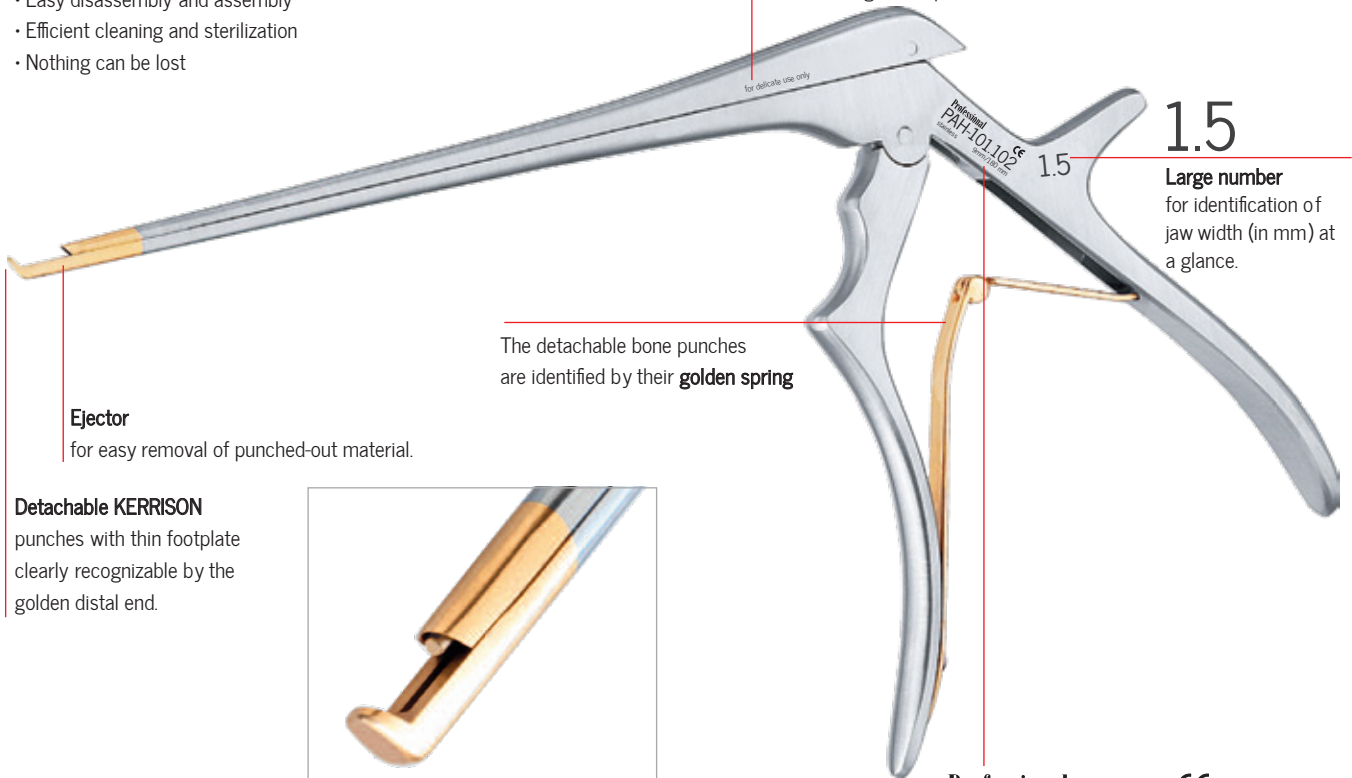

Ejector

for easy removal of punched-out material.

The detachable bone punches are identified by their **golden spring**

Detachable KERRISON

punches with thin footplate clearly recognizable by the golden distal end.



Professional ^{CE}
PAH-101.102
stainless 9mm/180 mm

Disassembly in 3 steps:

1. Unhook the spring from the rear handle.

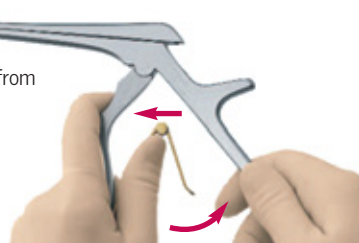

2. Close the handle completely and pull the inner handle downwards.

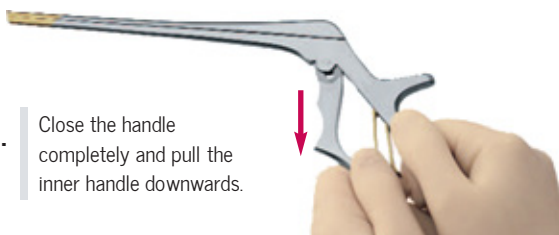











3. Pull back the slider to remove.

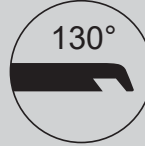









- non detachable
- detachable

Standard

Lengths - 180 mm











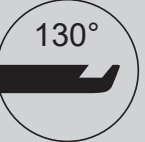

Width (mm)	upward	downward	130° upward	130° downward	Jaw Width	Ejector	
							
1.0		PAH-03.231	PAH-03.241	PAH-101.101	PAH-101.141	8 mm	
1.5				PAH-101.102		9 mm	
				PAH-101.103		15 mm	
2.0		PAH-03.232	PAH-03.242	PAH-101.104	PAH-101.144	9 mm	
				PAH-101.105		15 mm	
2.5				PAH-101.106		10 mm	
				PAH-101.107		15 mm	
3.0		PAH-03.233	PAH-03.243	PAH-101.108	PAH-101.148	10 mm	✓
				PAH-101.109		15 mm	✓
4.0		PAH-03.234	PAH-03.244	PAH-101.110	PAH-101.150	12 mm	✓
				PAH-101.111		15 mm	✓
5.0		PAH-03.235	PAH-03.245	PAH-101.112	PAH-101.152	12 mm	✓
				PAH-101.113		15 mm	✓
6.0		PAH-03.236	PAH-03.246	PAH-101.114		12 mm	✓
				PAH-101.115		15 mm	✓

Lengths - 200 mm

1.0				-		-	
1.5				PAH-102.102		9 mm	
2.0				PAH-102.104		9 mm	
				PAH-102.105		15 mm	
2.5				PAH-102.106		10 mm	
3.0				PAH-102.108		10 mm	✓
				PAH-102.109		15 mm	✓
4.0				PAH-102.110		12 mm	✓
				PAH-102.111		15 mm	✓
5.0				PAH-102.112		12 mm	✓
				PAH-102.113		15 mm	✓
6.0				PAH-102.114		12 mm	✓
				PAH-102.115		15 mm	✓







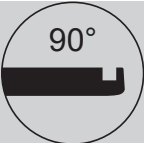
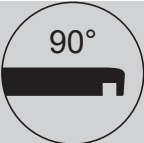
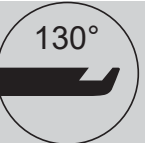

Standard

Length - 230 mm







Width (mm)	upward	downward	130° upward	130° downward	Jaw Width	Ejector
						
1.0			-	-	-	
1.5			-	-	-	
2.0			PAH-103.102	PAH-103.142	9 mm	
2.5			-	-	-	
3.0			PAH-103.108	PAH-103.148	10 mm	✓
4.0			PAH-103.110	PAH-103.150	12 mm	✓
5.0			PAH-103.112	PAH-103.152	12 mm	✓
6.0			-	-	-	

Thin

Length - 180 mm



















Width (mm)	upward	downward	130° upward	130° downward	Jaw Width	Ejector
						
1.0			PAH-111.101	PAH-111.141	8 mm	
1.5			PAH-111.102		9 mm	
2.0			PAH-111.104	PAH-111.144	9 mm	
2.5			PAH-111.106		10 mm	
3.0			PAH-111.108	PAH-111.148	10 mm	✓
4.0			PAH-111.110	PAH-111.150	12 mm	✓
5.0			PAH-111.112	PAH-111.152	12 mm	✓

Length - 200 mm

1.0			PAH-112.101		8 mm	
1.5			PAH-112.102		9 mm	
2.0			PAH-112.104		9 mm	
2.5			PAH-112.106		10 mm	
3.0			PAH-112.108		10 mm	✓
4.0			PAH-112.110		12 mm	✓
5.0			PAH-112.112		12 mm	✓

Thin

Lengths - 230 mm

Width (mm)	upward	downward	130° upward	130° downward	Jaw Width	Ejector
						
10			-	-	-	
15			-	-	-	
20			PAH-113.102	PAH-113.142	9 mm	
25			-	-	-	
30			PAH-113.108	PAH-113.148	10 mm	✓
40			PAH-113.110	PAH-113.150	12 mm	✓
50			PAH-113.112	PAH-113.152	12 mm	✓
Lengths - 280 mm						
1.0			-	-	-	
15			-	-	-	
20			PAH-114.102		9 mm	
25			-	-	-	
30			PAH-114.108		10 mm	✓
40			PAH-114.110		12 mm	✓
50			PAH-114.112		12 mm	✓

Detachable

- Easy disassembly and assembly
- Efficient cleaning and sterilization
- Nothing can be lost

for delicate use only

Punches with a thin footplate are used exclusively for removing small portions of bone and soft tissue

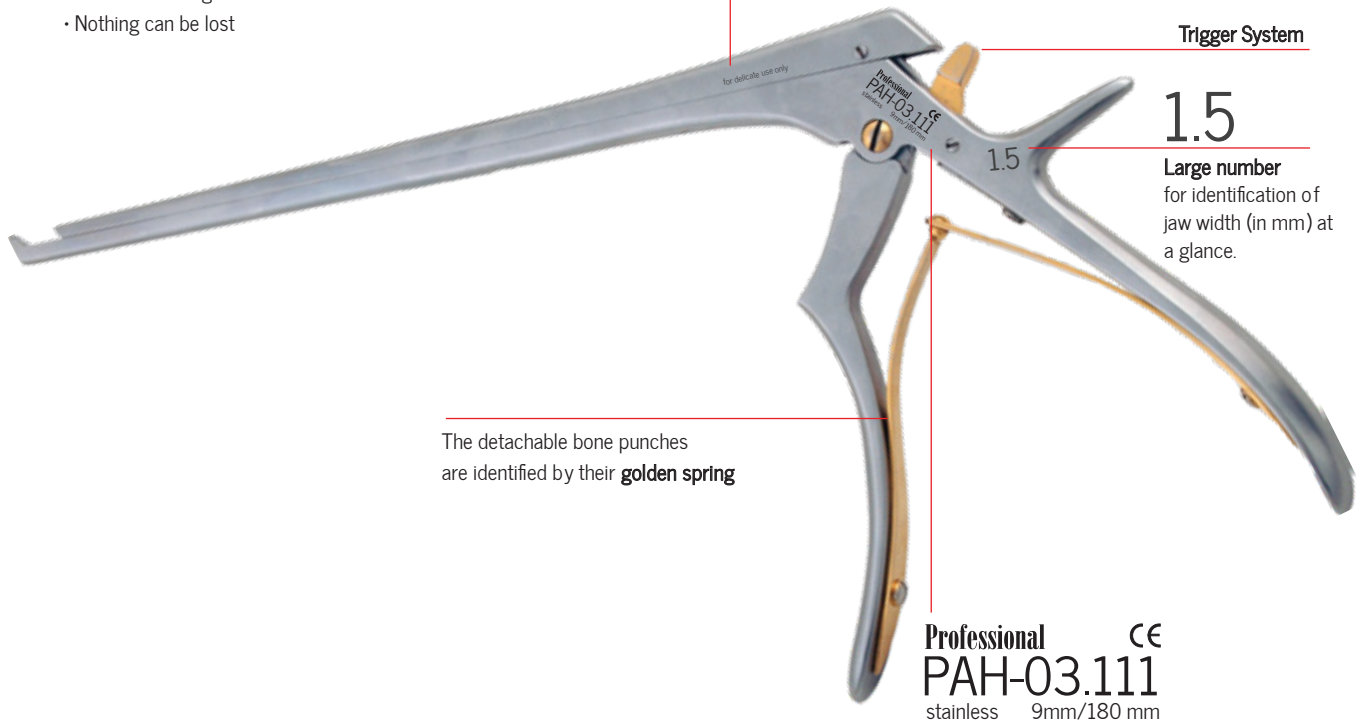

Trigger System

1.5

Large number for identification of jaw width (in mm) at a glance.

The detachable bone punches are identified by their **golden spring**

Professional **PAH-03.111** ^{CE}
stainless 9mm/180 mm

Disassembly in 3 steps:

1.

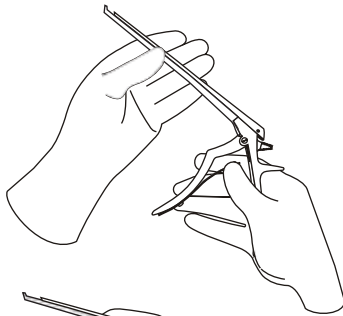

2.

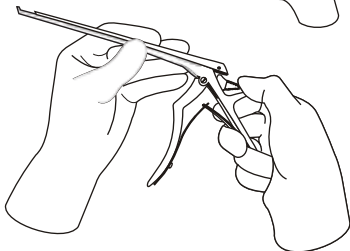



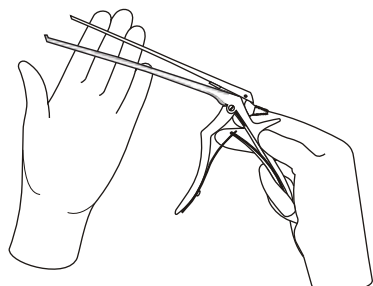









3.











Standard

Lengths - 180 mm









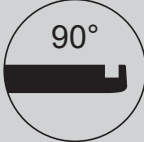

Width (mm)	upward	downward	130° upward	130° downward	Jaw Width	Ejector
						
1.0		PAH-03.101		PAH-03.121	8 mm	
1.5		PAH-03.111		PAH-03.131	9 mm	
		PAH-03.112		PAH-03.132	15 mm	
2.0		PAH-03.102		PAH-03.122	9 mm	
		PAH-03.113		PAH-03.133	15 mm	
2.5		PAH-03.114		PAH-03.134	10 mm	
		PAH-03.115		PAH-03.135	15 mm	
3.0		PAH-03.103		PAH-03.123	10 mm	✓
		PAH-03.116		PAH-03.136	15 mm	✓
4.0		PAH-03.104		PAH-03.124	12 mm	✓
		PAH-03.117		PAH-03.137	15 mm	✓
5.0		PAH-03.105		PAH-03.125	12 mm	✓
		PAH-03.118		PAH-03.138	15 mm	✓
6.0		PAH-03.106		PAH-03.126	12 mm	✓
					15 mm	✓

Lengths - 200 mm

1.0			-		-	
1.5				PAH-03.202	9 mm	
2.0				PAH-03.204	9 mm	
				PAH-03.205	15 mm	
2.5				PAH-03.206	10 mm	
3.0				PAH-03.208	10 mm	✓
				PAH-03.209	15 mm	✓
4.0				PAH-03.210	12 mm	✓
				PAH-03.211	15 mm	✓
5.0				PAH-03.212	12 mm	✓
				PAH-03.213	15 mm	✓
6.0				PAH-03.214	12 mm	✓
				PAH-03.215	15 mm	✓







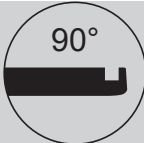
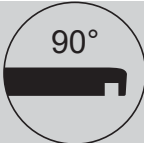
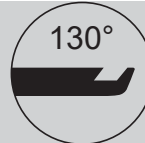
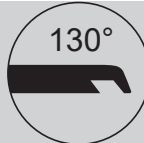

Standard

Lengths - 230 mm







Width (mm)	upward	downward	130° upward	130° downward	Jaw Width	Ejector
						
1.0			PAH-103.100		-	
1.5			PAH-103.101		-	
2.0			PAH-103.102		9 mm	
2.5			PAH-103.107		-	
3.0			PAH-103.108		10 mm	✓
4.0			PAH-103.110		12 mm	✓
5.0			PAH-103.112		12 mm	✓
			-		-	

Thin

Lengths - 180 mm













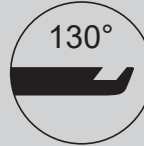





Width (mm)	upward	downward	130° upward	130° downward	Jaw Width	
						
1.0			PAH-110.101	PAH-111.141	8 mm	
1.5			PAH-110.102		9 mm	
2.0			PAH-110.104	PAH-111.144	9 mm	
2.5			PAH-110.106		10 mm	
3.0			PAH-110.108	PAH-111.148	10 mm	✓
4.0			PAH-110.110	PAH-111.150	12 mm	✓
5.0			PAH-110.112	PAH-111.152	12 mm	✓

Lengths - 200 mm

1.0			PAH-110.121		8 mm	
1.5			PAH-110.122		9 mm	
2.0			PAH-110.124		9 mm	
2.5			PAH-110.126		10 mm	
3.0			PAH-110.128		10 mm	✓
4.0			PAH-110.130		12 mm	✓
5.0			PAH-110.132		12 mm	✓

Thin

Lengths - 230 mm

Width (mm)	upward	downward	130° upward	130° downward	Jaw Width	Ejector
						
10			PAH-110.140		-	
15			PAH-110.141		-	
20			PAH-110.142		9 mm	
25			PAH-110.143		-	
30			PAH-110.148		10 mm	✓
40			PAH-110.150		12 mm	✓
50			PAH-110.152		12 mm	✓
Lengths - 280 mm						
10			PAH-110.160		-	
15			PAH-110.161		-	
20			PAH-110.162		9 mm	
25			PAH-110.163		-	
30			PAH-110.168		10 mm	✓
40			PAH-110.170		12 mm	✓
50			PAH-110.172		12 mm	✓

Non Glare

- Easy disassembly and assembly
- Coating

for delicate use only

Punches with a thin footplate are used exclusively for removing small portions of bone and soft tissue

The black surface coating prevents distracting light reflection.

Ejector

for easy removal of punched-out material.



The detachable bone punches are identified by their **golden spring**

3

Large number for identification of jaw width (in mm) at a glance.

Professional **PAH-101.248** ^{CE}
stainless 10mm/180 mm

Kerrison punches with a thin footplate are identified by their golden inner handle.

Assembly in 3 steps:

1. Attach the slider and push it forwards.

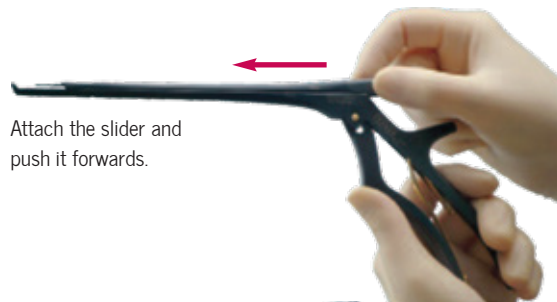

2. Push the inner handle upwards and open the handle.





3. Insert the spring in the rear handle.



Standard

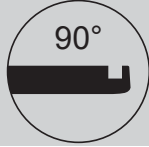
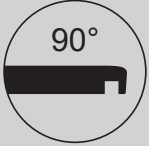

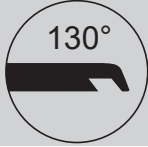







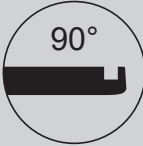















Lengths - 180 mm

Width (mm)	upward	downward	130° upward	130° downward	Jaw Width	Ejector
						
1.0	□	PAH-101.241		PAH-101.201	8 mm	
1.5	□			PAH-101.202	9 mm	
				PAH-101.203	15 mm	
2.0	□	PAH-101.244		PAH-101.204	9 mm	
				PAH-101.205	15 mm	
2.5	□			PAH-101.206	10 mm	
				PAH-101.207	15 mm	
3.0	□	PAH-101.248		PAH-101.208	10 mm	✓
				PAH-101.209	15 mm	✓
4.0	□	PAH-101.250		PAH-101.210	12 mm	✓
				PAH-101.211	15 mm	✓
5.0	□	PAH-101.252		PAH-101.212	12 mm	✓
				PAH-101.213	15 mm	✓
6.0	□	PAH-101.254		PAH-101.214	12 mm	✓
				PAH-101.215	15 mm	✓

Lengths - 200 mm

1.0	□		-		-	
1.5	□			PAH-102.202	9 mm	
2.0	□			PAH-102.204	9 mm	
				PAH-102.205	15 mm	
2.5	□			PAH-102.206	10 mm	
3.0	□			PAH-102.208	10 mm	✓
				PAH-102.209	15 mm	✓
4.0	□			PAH-102.210	12 mm	✓
				PAH-102.211	15 mm	✓
5.0	□			PAH-102.212	12 mm	✓
				PAH-102.213	15 mm	✓
6.0	□			PAH-102.214	12 mm	✓
				PAH-102.215	15 mm	✓

Thin





Lengths - 180 mm						
Width (mm)	upward	downward	130° upward	130° downward	Jaw Width	Ejector
						
1.0					PAH-111.201	8 mm
1.5					PAH-111.202	9 mm
2.0					PAH-111.204	9 mm
2.5					PAH-111.206	10 mm
3.0					PAH-111.208	10 mm ✓
4.0					PAH-111.210	12 mm ✓
5.0					PAH-111.212	12 mm ✓
6.0					PAH-101.254	12 mm ✓
Lengths - 200 mm						
1.0					PAH-112.201	8 mm
1.5					PAH-112.202	9 mm
2.0					PAH-112.204	9 mm
2.5					PAH-112.206	10 mm
3.0					PAH-112.208	10 mm ✓
4.0					PAH-112.210	12 mm ✓
5.0					PAH-112.212	12 mm ✓
Lengths - 230 mm						
2.0					PAH-113.202	9 mm
3.0					PAH-113.208	10 mm ✓
4.0					PAH-113.210	12 mm ✓
5.0					PAH-113.212	12 mm ✓
Lengths - 280 mm						
2.0					PAH-114.202	9 mm
3.0					PAH-114.208	10 mm ✓
4.0					PAH-114.210	12 mm ✓
5.0					PAH-114.212	12 mm ✓

Curved KERRISON punch, upbiting

Classic non-detachable bone punch with an upbiting curved jaw for easy removal of bone material, especially from between the vertebral arches.



Lengths - 200 mm





Width (mm)	Art. No.	Jaw Width
2.0 	PAH-151.02	10 mm
3.0 	PAH-151.03	10 mm
4.0 	PAH-151.04	10 mm
5.0 	PAH-151.05	10 mm

Bayonet-shaped KERRISON punch, 130° upbiting

Classic non-detachable bayonet-shaped bone punch for optimal vision over the shaft of the instrument in the operating area.



Lengths - 240 mm



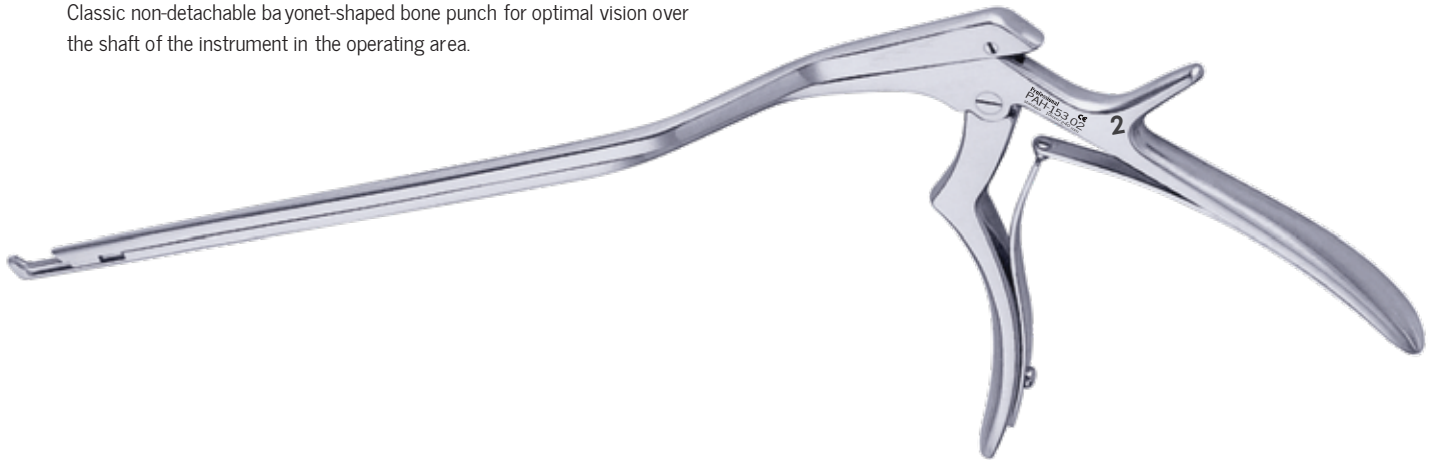

Width (mm)	Art. No.	Jaw Width
2.0 	PAH-152.02	10 mm
3.0 	PAH-152.03	10 mm
4.0 	PAH-152.04	10 mm
5.0 	PAH-152.05	10 mm

Bayonet-shaped KERRISON punch, 130° upbiting

Classic non-detachable bayonet-shaped bone punch for optimal vision over the shaft of the instrument in the operating area.



Lengths - 240 mm

Width (mm)	Art. No.	Jaw Width
2.0 	PAH-153.02	10 mm
3.0 	PAH-153.03	10 mm
4.0 	PAH-153.04	10 mm
5.0 	PAH-153.05	10 mm

For removal of intervertebral disc tissue we offer an extensive assortment of rongeurs. Your advantages are:

1. All rongeurs are also available as detachable models enabling an effective cleaning. Connections and joints are freely accessible which avoids unwashed areas. By effected easily and quickly. The detached rongeurs stay stay one part and can be assembled again without any problems.
2. The black coating guarantees a reflexion free working as well as hard surface.



Disassembly



Hold the rongeur with both hands and pull the release button.

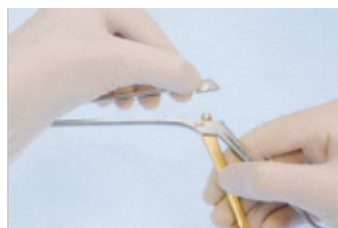

For cleaning purposes please move the sliding part upwards.

Assembly



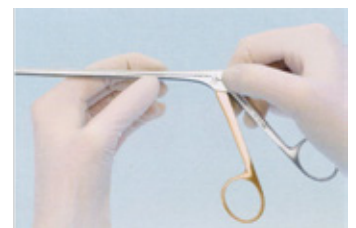

Please insert the sliding part so that the release button is over the loop of the handle part.

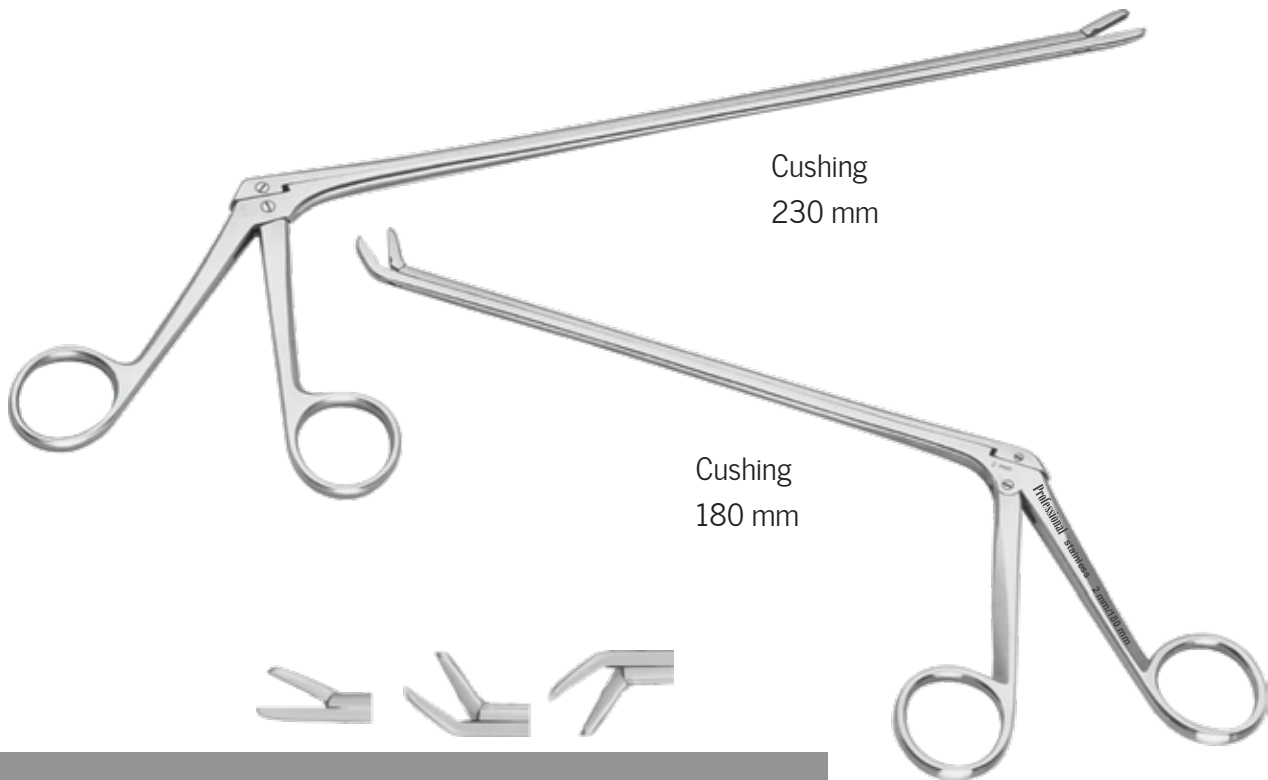

Please keep the release button pulled and push the sliding part down.

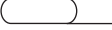



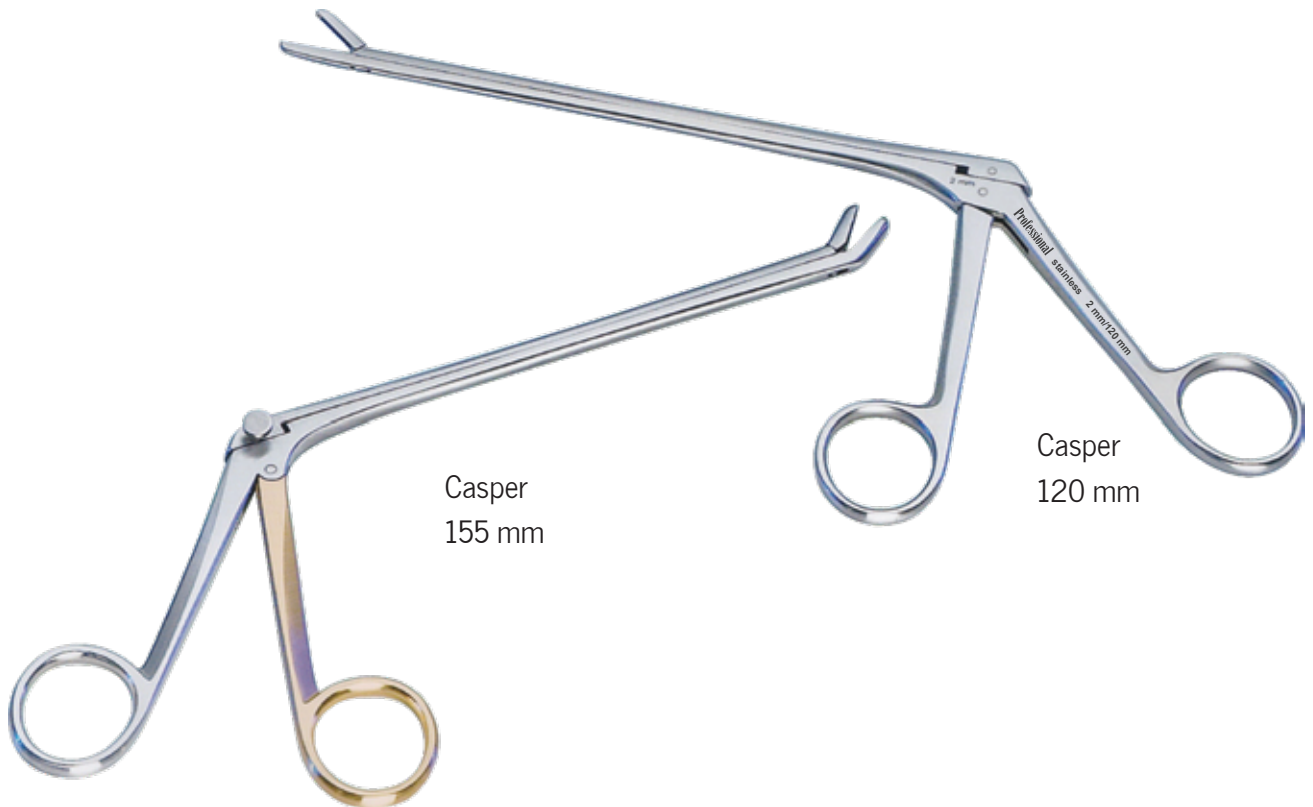

	Art. No.	Art. No.	Art. No.	Lengths
<p>CUSHING 2 x 10 mm</p> 	PAH-04.02	PAH-04.32	PAH-04.62	130 mm
	PAH-04.102	PAH-04.132	PAH-04.162	130 mm
	PAH-04.15	PAH-04.45	PAH-04.75	150 mm
	PAH-04.115	PAH-04.145	PAH-04.175	150 mm
	PAH-04.22	PAH-04.52	PAH-04.82	180 mm
	PAH-04.122	PAH-04.152	PAH-04.182	180 mm
	PAH-04.23	PAH-04.53	PAH-04.83	230 mm
	PAH-04.123	PAH-04.153	PAH-04.183	230 mm
	PAH-28	PAH-04.58	PAH-04.88	280 mm
	PAH-128	PAH-04.158	PAH-04.188	280 mm
<p>LOVE-GRUENWALD 3 x 10 mm</p> 	PAH-08.03	PAH-08.33	PAH-08.63	130 mm
	PAH-08.103	PAH-08.133	PAH-08.163	130 mm
	PAH-08.15	PAH-08.45	PAH-08.75	150 mm
	PAH-08.115	PAH-08.145	PAH-08.175	150 mm
	PAH-08.23	PAH-08.53	PAH-08.83	180 mm
	PAH-08.123	PAH-08.153	PAH-08.183	180 mm
	PAH-08.24	PAH-08.54	PAH-08.84	230 mm
	PAH-08.124	PAH-08.154	PAH-08.184	230 mm
	PAH-08.28	PAH-08.58	PAH-08.88	280 mm
	PAH-08.128	PAH-08.158	PAH-08.188	280 mm
<p>SPURLING 4 x 10 mm</p> 	PAH-11.83	PAH-11.93	PAH-11.94	130 mm
	PAH-11.183	PAH-11.193	PAH-11.194	130 mm
	PAH-11.85	PAH-11.95	PAH-11.96	150 mm
	PAH-11.185	PAH-11.195	PAH-11.196	150 mm
	PAH-11.88	PAH-11.98	PAH-11.99	180 mm
	PAH-11.188	PAH-11.198	PAH-11.199	180 mm
	PAH-11.89	PAH-11.99	PAH-11.100	230 mm
	PAH-11.189	PAH-11.199	PAH-11.201	230 mm
	PAH-11.90	PAH-11.101	PAH-11.102	280 mm
	PAH-11.190	PAH-11.201	PAH-11.202	280 mm

non detachable
 detachable

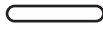





Casper

	Art. No.	Art. No.	Art. No.	Lengths
2 mm 	PAH-05.54	PAH-05.64	PAH-05.74	120 mm
	PAH-05.154	PAH-05.164	PAH-05.174	120 mm
	PAH-05.56	PAH-05.66	PAH-05.76	155 mm
	PAH-05.156	PAH-05.166	PAH-05.176	155 mm
	PAH-05.58	PAH-05.68	PAH-05.78	180 mm
	PAH-05.158	PAH-05.168	PAH-05.178	180 mm
3 mm 	PAH-06.54	PAH-06.64	PAH-06.74	120 mm
	PAH-06.154	PAH-06.164	PAH-06.174	120 mm
	PAH-06.56	PAH-06.66	PAH-06.76	155 mm
	PAH-06.156	PAH-06.166	PAH-06.176	155 mm
	PAH-06.58	PAH-06.68	PAH-06.78	180 mm
	PAH-06.158	PAH-06.168	PAH-06.178	180 mm
4 mm 	PAH-07.54	PAH-07.64	PAH-07.74	120 mm
	PAH-07.154	PAH-07.164	PAH-07.174	120 mm
	PAH-07.56	PAH-07.66	PAH-07.76	155 mm
	PAH-07.156	PAH-07.166	PAH-07.176	155 mm
	PAH-07.58	PAH-07.68	PAH-07.78	180 mm
	PAH-07.158	PAH-07.168	PAH-07.178	180 mm
5 mm 	PAH-09.54	PAH-09.64	PAH-09.74	120 mm
	PAH-09.154	PAH-09.164	PAH-09.174	120 mm
	PAH-09.56	PAH-09.66	PAH-09.76	155 mm
	PAH-09.156	PAH-09.166	PAH-09.176	155 mm
	PAH-09.58	PAH-09.68	PAH-09.78	180 mm
	PAH-09.158	PAH-09.168	PAH-09.178	180 mm

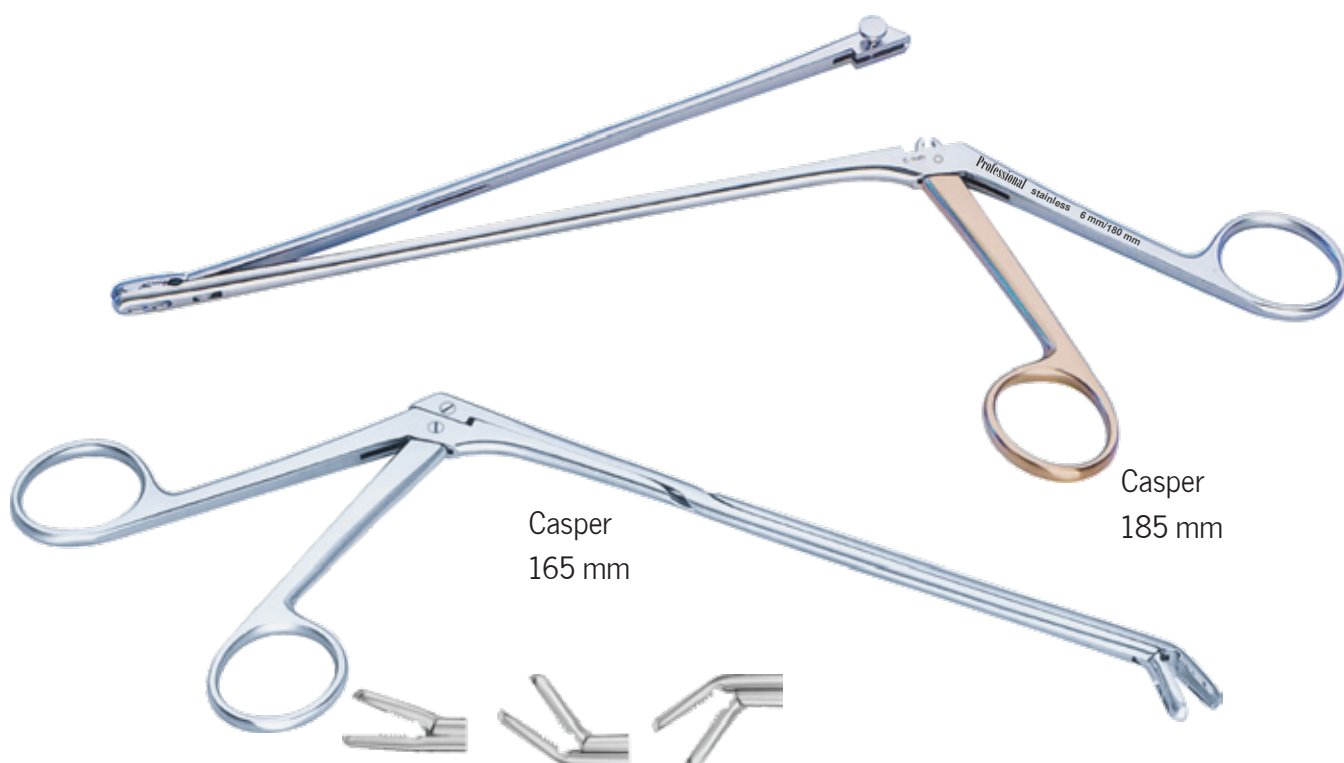
non detachable

detachable

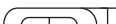
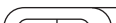

	Art. No.	Art. No.	Art. No.	Lengths
2 x 12 mm 	PAH-05.04	PAH-05.34	PAH-05.44	140 mm
	PAH-05.104	PAH-05.134	PAH-05.144	140 mm
	PAH-05.06	PAH-05.36	PAH-05.46	160 mm
	PAH-05.106	PAH-05.136	PAH-05.146	160 mm
	PAH-05.08	PAH-05.38	PAH-05.48	185 mm
	PAH-05.108	PAH-05.138	PAH-05.148	185 mm
3 x 12 mm 	PAH-06.04	PAH-06.34	PAH-06.44	140 mm
	PAH-06.104	PAH-06.134	PAH-06.144	140 mm
	PAH-06.06	PAH-06.36	PAH-06.46	160 mm
	PAH-06.106	PAH-06.136	PAH-06.146	160 mm
	PAH-06.08	PAH-06.38	PAH-06.48	185 mm
	PAH-06.108	PAH-06.138	PAH-06.148	185 mm
4 x 14 mm 	PAH-07.04	PAH-07.34	PAH-07.44	140 mm
	PAH-07.104	PAH-07.134	PAH-07.144	140 mm
	PAH-07.06	PAH-07.36	PAH-07.46	160 mm
	PAH-07.106	PAH-07.136	PAH-07.146	160 mm
	PAH-07.08	PAH-07.38	PAH-07.48	185 mm
	PAH-07.108	PAH-07.138	PAH-07.148	185 mm
5 x 14 mm 	PAH-09.04	PAH-09.34	PAH-09.44	140 mm
	PAH-09.104	PAH-09.134	PAH-09.144	140 mm
	PAH-09.06	PAH-09.36	PAH-09.46	160 mm
	PAH-09.106	PAH-09.136	PAH-09.146	160 mm
	PAH-09.08	PAH-09.38	PAH-09.48	185 mm
	PAH-09.108	PAH-09.138	PAH-09.148	185 mm
6 x 16 mm 	PAH-10.04	PAH-10.34	PAH-10.44	140 mm
	PAH-10.104	PAH-10.134	PAH-10.144	140 mm
	PAH-10.06	PAH-10.36	PAH-10.46	160 mm
	PAH-10.106	PAH-10.136	PAH-10.146	160 mm
	PAH-10.08	PAH-10.38	PAH-10.48	185 mm
	PAH-10.108	PAH-10.138	PAH-10.148	185 mm



Mouth fenestrated and serrated

- non detachable
- detachable

Professional

Envision Life

Professional Hospital Furnishers

A faint, light blue world map is centered in the background of the page, showing the outlines of continents and oceans.

19-A (N), Industrial Estate, Sialkot-51310, Pakistan.

Tel. +92 52 355 8074, 325 6440
Email: info@phfworld.com

www.phfworld.com